



QRG

QUALITY-RESOURCE.COM

PRODUCT CATALOG 2024



YOUR INDUSTRY EXPERTS ARE FOCUSED ON

SUSTAINABILITY



MAKE SUSTAINABLE CHOICES AND LEARN ABOUT THE BENEFITS OF OUR ECO-FRIENDLY MEDIA



RECYCLED POLYESTER KNIT

This 100% recycled media is made with REPREVE® fibers. REPREVE® transforms plastic bottles into certifiable, traceable, high-performance yarn. Recycled bottles are collected worldwide, cleaned and flaked, and made into REPREVE® resin that can be made into fibers.

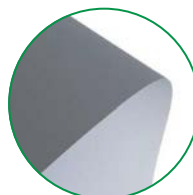

PVC-FREE MEDIA

This PVC-free media is made from polyester, nylon and polyurethane. The benefits of PVC-free media include a reduction in toxic chemicals released into the environment, lower levels of VOCs (volatile organic compounds) for improved indoor air quality, and increased sustainability with energy-efficient production processes.



BIODEGRADABLE FABRIC

This media is made with CiCLO® technology. CiCLO®-treated microfibers biodegrade 91.1% compared to untreated microfibers, a rate comparable to wool.

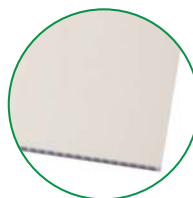

CORRUGATED PLASTIC

This corrugated plastic is made of 100% polypropylene. This media is 100% recyclable. Recycling of plastic combats adverse environmental impacts; polypropylene is blue bin recyclable and falls under the #5 resin recyclability code.



CORRUGATED CARDBOARD AND PAPER-BASED MEDIA

Made from cellulose-based printing paper and corrugated cardboard. Media is recyclable through a majority of curbside recycling programs.

Discover our sustainable products!



This icon under a product name means sustainable options are available.



1. 2'H EuroFit Tabletop Straight Wall
Page 154.

2. 5' Economy Tent
Page 99.



3. 6'W EuroFit Straight Wall
Page 162.

4. 10' Omni Tent
Page 104.



5. Aerial SEG
Page 136.

6. Aerial SEG Glo
Page 136.



7. CounterPop
New sizes. Page 193.

8. Essential Banner Display
Page 49.



9. Dual Retractor
Page 34.



10. EuroFit Straight Wall with Biodegradable Fabric
Page 165.

11. Fabric Flags

New sizes and shapes. Pages 78-79.



12. Galleria A-frame
Page 124.



13. Impress Lite A-frame
Page 123.



14. Journey SEG
New sizes. Pages 170-171.

15. Prime LED Light
Page 201.

16. ShowGlower Counter
Page 197.

17. ShowGlower Totem
Page 197.

18. ShowGlower Totem Table
Page 197.



WE'VE ADDED OVER 30
NEW PRODUCTS

19. **Standard Wall-Mount SEG Glo**
 New sizes. *Page 135.*

 20. **Stratus Retractor with PVC-Free Media**
 New media. *Pages 36-37.*

21. **Tabletop Economy Retractor with Dry-Erase Media**
 New media. *Page 33.*

 22. **Tower Trio**
Page 132.

23. **UV-Printed Canopy**
Pages 100-108.

 24. **Value Wall-Mount SEG**
 New sizes. *Page 134.*

25. **Wayfinding Sign**
Page 131.

26. **Wayfinding Sign Post**
Page 133.

27. **Wood Prints**
Page 148.



RECYCLED POLYESTER KNIT
 Our polyester knit has been upgraded to a sustainable recycled polyester knit! It is made with REPREVE® fibers recycled from plastic bottles. See website for more information.

See pages 6-7 for a complete list of new products!

NEED YOUR ORDER FAST? RUSHES ARE AVAILABLE!

Rush service requires approval by customer care.
See page 210 for details.
Same day service not available.



PRODUCTION LEAD TIMES

Production lead times listed for each product are subject to capacity and inventory levels. Your order will be scheduled within our production lead times or with rush service as requested to meet a required in-hands date. The factory reserves the right to adjust lead times. Customers will be contacted regarding affected orders.

PRODUCTION BEGINS UPON RECEIPT OF:

- Complete purchase order
- Payment/credit approval
- Production-ready artwork
- Final proof approval



QUICK SHIPS SELECT PRODUCTS SHIP IN JUST 24 OR 48 HOURS.

Products are available online. Order must be placed via our website. See website for complete Quick Ship program requirements and ordering information.



KITTING & FULFILLMENT SERVICES WE COVER EVERYTHING!

Our company is proud to offer our Kitting and Fulfillment Services program. If you require kitting or other fulfillment needs for your order, we have you covered!

Simply contact your Sales Rep to discuss your needs and to get more information on this amazing service.



USER-FRIENDLY PAGE LAYOUT: FIND PRODUCT INFO QUICK & EASY

ICONS

These icons identify features and services associated with each product, see page 7.

SUGGESTED PRODUCT USES
Inspiration for how these products can be used.

PRODUCT DETAILS
Additional product information alongside detailed images.

PRODUCT SPECIFICATIONS
Dimensions, weights, sizes and materials.

PRODUCTION LEAD TIME
The number of days an imprinted product will take to produce *after* receiving final proof approval (see page 210 for details).

VISIT OUR WEBSITE FOR DETAILED PRODUCT INFORMATION



ARTWORK TEMPLATES

Download PDF templates and set up your artwork using industry-preferred design software.

PRODUCT IMAGES

Detailed and high-resolution images of product features.

PRODUCT INSTRUCTIONS

Detailed PDF instructions are available to view, print or download.

ASSEMBLY VIDEOS

Step-by-step assembly instruction videos ensure quick and easy setup.

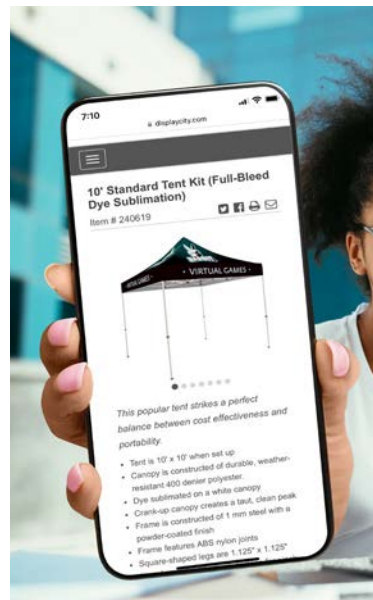

TABLE COVERS (10-27)

Antimicrobial Table Throw	22
★ Convertible Table Throw	16
★ Economy Table Throw	12-13
◆ Eco-Wise Table Throw	19
◆ Enviro Pro Table Throw NEW!	19
Fitted Round Table Throw	24
Fitted Table Throw	25
Lateral Table Runner	26
LazerLine Table Runner	26
★ LazerLine Table Throw	17
● Outdoor Fitted Table Throw	25
★ Premium Table Throw	18
Round Table Throw	24
Stain-Resistant Table Throw	23
★ Standard Table Runner	27
★ Standard Table Throw	14-15
TABLE COVER COMPARISON CHART	11
UltraFit Crossover	21
★ UltraFit Table Throw	20-21
Value Lite Table Throw	23

RETRACTABLE BANNERS (28-45)

★ Deluxe Pro Retractor	35
◆ Dual Retractor NEW!	34
◆ Eco-Lite Retractor	43
★ Economy Plus Retractor	38
★ ◆ Economy Retractor NEW!	32-33
● Element Retractor	42
★ Ideal Retractor	30
InstaChange Retractor	39
★ Jumbo Wide Retractor	44
MagnaLink Retractor	41
★ ◆ Mini Retractors NEW!	45
● Outdoor Trek Lite Retractor	42
RETRACTABLE BANNER COMPARISON CHART	29
★ Spotlight Retractor	40
★ ◆ Stratus Retractor NEW!	36-37
Superb Retractor	41
★ Value Retractor	31

BANNER DISPLAYS (46-59)

Curved Cantilever Banner Display	53
EasySnap Banner Display	53
Essential Banner Display NEW!	49
Euro-X Banner Display	50
◆ EuroFit Angle Banner Display NEW!	57
◆ EuroFit Banner Display (<i>Biodegradable Media</i>) NEW!	55
★ EuroFit Banner Display (<i>Recycled Polyester Knit</i>) NEW!	54
◆ EuroFit Hanging Banner NEW!	58
◆ EuroFit Pro Hanging Banner NEW!	58
◆ EuroFit Round Banner Display NEW!	56
★ Everyday Banner Displays	51
◆ Everyday Impress Display NEW!	52
◆ Flex Banner Display NEW!	52
★ FrameWorx Banner Display	47
★ FrameWorx Face Cutout Banner Display	48
★ ● Headliner Banner Display NEW!	59
● Headliner Face Cutout Banner Display	59
◆ ● Outdoor Ballast Display NEW!	59
Taurus Banner Display	50
Tri-X Banner Display	50
Xpress Banner Display	49

BANNERS & FLAGS (60-95)

BANNER MATERIAL COMPARISON CHART	61
★ ● Banners - 9 oz. Mesh Vinyl	62
◆ ● Banners - 9 oz. PVC-Free	64
● Banners - 10 oz. Scrim Vinyl	62
★ ● Banners - 13 oz. Scrim Vinyl	62
Banners - 13 oz. Smooth Scrim Vinyl	63
★ ● Banners - 18 oz. Opaque Scrim Vinyl	63
● Banners - Fence	64
◆ ● Banners - Parade NEW!	68
Banners - Poly Poplin	65
Banners - Satin	65
● Banners - Super Poly Knit Fabric	65
◆ ● Banners - Tearaway NEW!	68
● Boulevard Banners - Brackets	67
● Boulevard Banners - Fabric	66
● Boulevard Banners - Vinyl	66
● Boulevard Banners - Wall-Mount Bracket System	67
FLAG COMPARISON CHART	69
● Flags - Car	80
● Flags - City	75
★ ● Flags - Fabric Bugee NEW!	79
● Flags - Fabric Guidon NEW!	79
● Flags - Fabric Pennant NEW!	79
● Flags - Fabric Rectangle NEW!	78
● Flags - Golf	80
● Flags - Historical	74
● Flags - International	74
● Flags - Military	73
● Flags - Nylon Bugee	71
● Flags - Nylon Guidon	71
● Flags - Nylon Pennant	71
★ ● Flags - Nylon Rectangle	70
● Flags - Pennant String	81
● Flags - Religious	76
● Flags - Solid-Color Nylon	76
● Flags - Spirit	77
● Flags - State	75
● Flags - Stick NEW!	81
● Flags - United States	72
● Flutter Flags - Solid-Color	93
● Flutter Flags - Stadium	92
● Insta-Flag Pole	77
SAIL SIGN COMPARISON CHART	82-83
★ ● Sail Sign - Accessories NEW!	94-95
● Sail Sign - Elite	90-91
● Sail Sign - Mini	93
★ ● Sail Sign - Premium	88-89
● Sail Sign - Solid-Color	92
★ ● Sail Sign - Streamline	86-87
★ ● Sail Sign - Value	84-85

TENTS (96-111)

● 5' Economy NEW!	99
● 5' Economy Plus NEW!	99
★ ● 6' & 8' Deluxe	101
★ ● 10' Deluxe NEW!	102
● 10' Economy	99
● 10' Economy Plus	99
● 10' Elite NEW!	108
● 10' Omni NEW!	104
★ ● 10' Premium NEW!	105
● 10', 15' & 20' Premium Gable	107
★ ● 10' Standard NEW!	100
● 10' Tent with Vented Canopy	103
● 10' Tent and Wall Kits NEW!	109
★ ● 15' & 20' Premium	106
● Accessories	109
TENT COMPARISON CHART	97-98
● Walls NEW!	110-111

GAMES & EVENTS (112-117)

● Bag Toss Buddy	114
★ ● Bag Toss Game	114
● Barricade Cover	116
Belt Barriers	117
Belt Barrier Sign Holder	117
Belt Barrier Wall-Mount	117
● Custom Printed Bean Bags	114
◆ ● EuroFit Barricade NEW!	116
● Outdoor Event Cooler	115
● Selfie Frame	113
★ Spin 'N Win Prize Wheel	113
● TrashWorks	115

SIGNAGE (118-141)

◆ Aerial SEG NEW!	136
Aerial SEG Glo NEW!	136
◆ ● Arch A-Frame NEW!	126
◆ ● Coro A-Frame	126
★ ◆ ● Corrugated Plastic Sign	127
Crystal Edge Display	137
● Deluxe Wood A-Frame	121
● Economy Wood A-Frame	121
◆ ● EuroFit Flex Sign NEW!	128
◆ ● EuroFit Swivel Sign NEW!	129
Flat Base Sign Display	133
Floor Decor	141
Floor Hugger Mat NEW!	141
● FrameWorx Flex	127
◆ Galleria A-Frame NEW!	124
● Horizontal A-Frame	125
◆ Impress A-Frame NEW!	123
◆ Impress Lite A-Frame NEW!	123
Indoor Surface Grip	140
LED Light Box	137
Luxe Glo Edge	138
Luxe Glo Message Board	138
Luxe Glo Sign	138
● Magnet Promo Sign	139
● Opaque Window Cling	139
● Outdoor Flex Signs	128
● Outdoor Surface Tac	140
● Parking Pal	131
● Rover Portable Sign Post	129
SIGNAGE COMPARISON CHART	119
★ ● Signicade A-Frame	120
★ ● Signicade Deluxe A-Frame	120
● Simpo Sign II A-Frame	120
Standard Wall-Mount SEG Glo NEW!	135
● Step Stake	127
★ ● Storm Mat	141
● Sunrise Lawn Sign	130
● Sunrise Multisurface Sign	130
● Superstrong Angle Iron A-Frame	124
● Swing A-Frame	121
◆ Tower Trio NEW!	132
● Twist-Up Oval A-Frame NEW!	125
Uptown A-Frame	122
Uptown Accent A-Frame	122
◆ Value Wall-Mount SEG NEW!	134
● Wayfinding Sign NEW!	131
Wayfinding Sign Post NEW!	133



Best Seller

Ideal for Outdoor Use



Sustainable Product

NEW! New, New & Improved, or New Styles Added to the Product Line

DECOR (142-149)

★ Acrylic Prints	146
Aluminum Prints	145
Blankets	144
● Door Wrap	143
★ Floating Gallery Prints	147
★ Gallery Prints	147
● Garden Flag	143
Indoor Pillows	144
◆ Lux Prints NEW!	146
◆ Removable Wallpaper	149
Tapestries	148
Wall Decal	149
Wood Prints NEW!	148

TABLETOP DISPLAYS (150-159)

Dynamo Trifecta Display	157
◆ Enviro Board Tabletop Display	155
◆ EuroFit Tabletop Straight Wall NEW!	154
Fast Trak Display	156
Micro GeoMetrix Back Wall	153
★ Micro GeoMetrix Display	152
Micro GeoMetrix Graphic Panels	153
★ ◆ Mini Displays NEW!	159
★ ◆ Mini Retractors	158
◆ Over-The-Top Display NEW!	155
Show 'N Write Display	157
◆ Splash Tabletop Display NEW!	151

FLOOR DISPLAYS (160-191)

ARISE Pop-Up Display	191
◆ Bravo Expanding Display NEW!	177
Case-to-Counter Conversion Kit NEW!	190, 191
◆ Deluxe Exhibitor Expanding Display NEW!	177
Deluxe GeoMetrix Back Wall	188
Deluxe GeoMetrix Connector Display	186-187
★ Deluxe GeoMetrix Display	184-185
Deluxe GeoMetrix Edge Panels	188
Echo Pop-Up Display	189
◆ EuroFit - Arch Plus NEW!	168
◆ EuroFit - Bow NEW!	167
◆ EuroFit - Evolution Displays NEW!	169
◆ EuroFit - Infinity NEW!	167
EuroFit - Light Clamp	166
◆ EuroFit - Plus NEW!	164
◆ EuroFit - Straight Wall (Biodegradable Media) NEW!	165
★ ◆ EuroFit - Straight Wall (Recycled Polyester Knit) NEW!	162-164
◆ EuroFit - Triumph with Runner NEW!	168
EuroFit - Vinyl Wall Barrier	167
EuroFit - Wall Accessories	166
EuroFit - Wheeled Feet	166
GeoMetrix and Deluxe GeoMetrix Graphic Panels	188
GeoMetrix Display	182-183
LitFit Wall NEW!	176
Pipe & Drape Banner and Header	176
POP-UP COMPARISON CHART	178-179
SEG - Deluxe Glo NEW!	173
SEG - Deluxe & Fusion Glo Corner Connector Set	173
SEG - Fusion Glo NEW!	174
◆ SEG - Journey NEW!	170-171
SEG - Journey Modular Connector Sets NEW!	171
SEG - Premier Glo NEW!	175
SEG - Standard Glo NEW!	172
Show 'N Rise Pop-Up Display	190
★ ◆ Splash Display NEW!	180-181

STANDS & FURNITURE (192-199)

◆ CounterPop NEW!	193
● Director's Chair	198
Easels	199
Impress Counters	194
Literature Displays	199
Power Pedestal	195
ShowGoer Case-to-Podium	194
ShowGlower Counter NEW!	197
ShowGlower Podium NEW!	195
ShowGlower Power Station NEW!	196
ShowGlower Power Table NEW!	196
ShowGlower Power Tower NEW!	198
ShowGlower Totem NEW!	197
ShowGlower Totem Table NEW!	197

ACCESSORIES (200-201)

Hard Cases	200
Soft Cases	201
Prime LED Light Kit NEW!	201
★ Ultimate LED Light Kits	201

TOTAL SHOW PACKAGES (202-207)

◆ Change-Up NEW!	204
● Market Fest	206
Micro GeoMetrix Merchandiser	207
◆ Micro GeoMetrix Pop-Up NEW!	204
◆ Photo Fun Indoor NEW!	205
◆ Product Promoter NEW!	205
◆ Product Sampler NEW!	206
Tabletop Classic	203
● Tailgater	207
Trunk-to-Anywhere	203

USER-FRIENDLY ICONS

These icons identify features and services associated with each product.



ANTIMICROBIAL

This product is made of material with properties that inhibit the spread of germs and viruses.



MADE IN THE USA

This product is manufactured in the USA.



BEST SELLER

This is one of our best-selling products.



OUTDOOR USE

This product is suitable for outdoor use during mild weather conditions.



CASE

This product includes a hard case or soft carry case. See Kit Includes in the pricing table for details.



PRODUCT WARRANTY

This is the duration of this product warranty (see page 210 for details).



CANOPY WARRANTY

This is the duration of this canopy warranty (see page 210 for details).



QUICK SHIP

We can ship this item in 24 or 48 hours (see website for details).



CUSTOM SHAPE

This product can be cut into custom shapes.



RCAT RATING

A rating that relates to the durability of a retractable banner (see page 29 for details).



GRAPHICS ONLINE

Graphic-only options available on our website.



SUSTAINABLE PRODUCT

This product is made with recycled materials, recyclable materials or biodegradable media. Check your local recycling guidelines.



HARDWARE ONLINE

Hardware-only options available on our website.



TOOL(S) REQUIRED

This product requires tool(s) for setup; tool(s) included.



HARDWARE WARRANTY

This is the duration of the hardware warranty (see page 210 for details).



VIDEO SETUP

Video setup instructions for this product can be found on our website.



LIGHTS UP

This product lights up.



WIND RATING

This product has been rated on the Beaufort Wind Rating (see page 211). Wind ratings were determined utilizing all available securing/stabilizing options sold with or offered for the product.



MACHINE-WASHABLE

This product's graphic is machine-washable on gentle cycle using mild detergent.

TABLE COVERS

When choosing a table cover
have you considered...

- **SIZE** - What size is your table?
- **FABRIC/MEDIA** - What type of material are you looking for?
- **FREQUENCY** - How often will you be using your table cover?
- **USE** - Will people be sitting at the table, or will it be used to showcase merchandise or promotional materials?
- **MESSAGE** - Do you want a logo printed on the front or would you like a design that covers the entire throw?

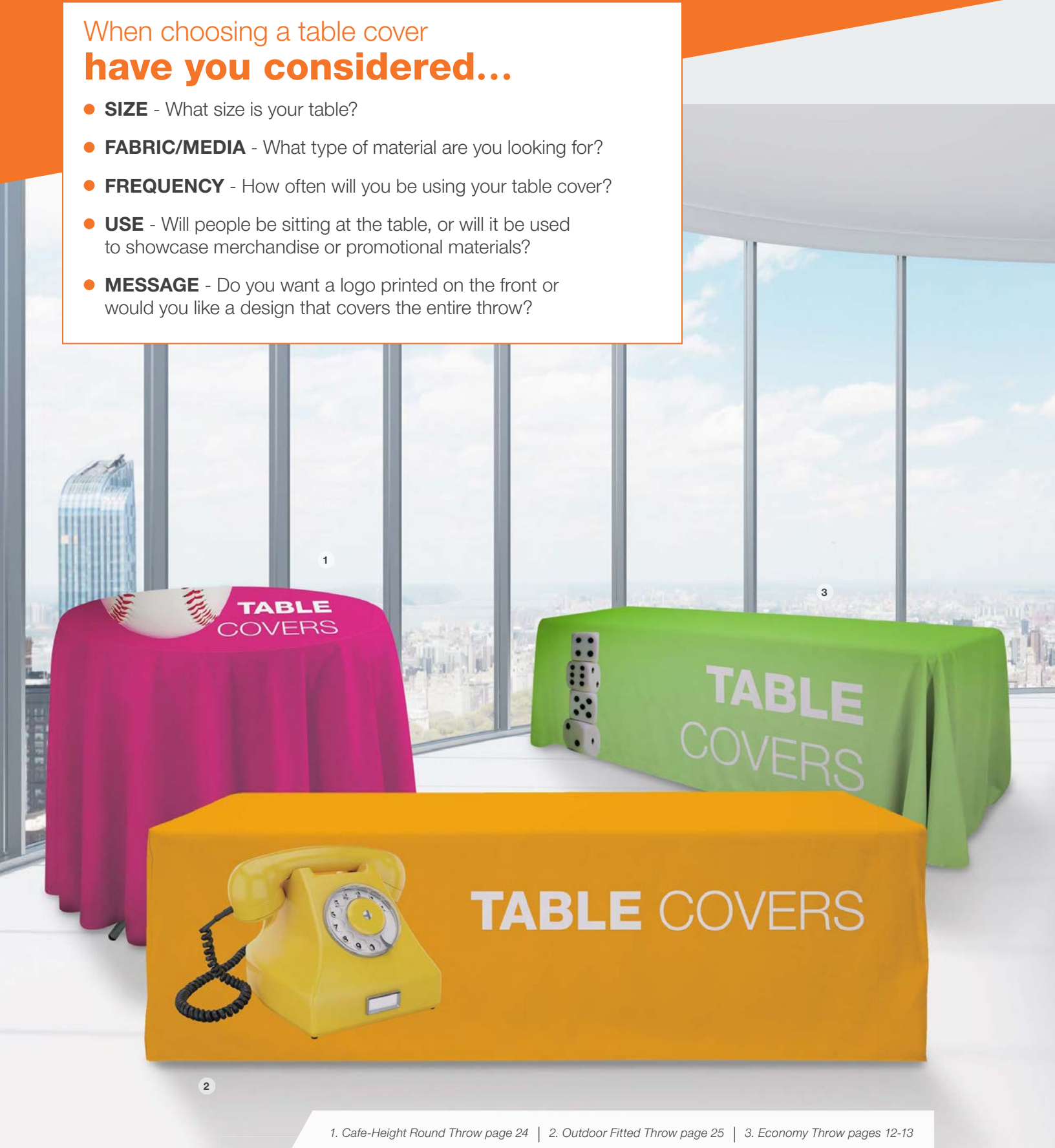

TABLE COVER COMPARISON CHART

BEST SELLERS ★ SUSTAINABLE ◆	TABLE SIZES	TABLE FIT	TABLE COVERAGE		MATERIAL	FINISHED EDGE	FR	WASH OPTIONS	PRINT OPTIONS				
			3-SIDED	4-SIDED					FULL-COLOR IMPRINT	FULL-COLOR FRONT ONLY	FULL-COLOR FULL-BLEED		
RECTANGLE	PG #	4' 6' 8' 12' 16'											
Antimicrobial	22	X X X			Drape	X X	Antimicrobial Polyester Knit	Hemmed	✓	Machine			X
Convertible ★	16		X		Drape / Fitted		Polyester Poplin	Serged	✓	Machine		X	X
Economy ★	12	X X X X X			Drape	X	Polyester Poplin	Serged	✓	Machine		X	X
Eco-Wise ◆	19		X X		Drape	X X	Biodegradable Fabric	Serged	✓	Machine			X
NEW! Enviro Pro ◆	19		X X		Drape	X X	Recycled Polyester Knit	Serged	✓	Machine			X
Fitted	25	X X X			Fitted		Polyester Poplin	Serged	✓	Machine		X	X
LazerLine ★	17		X X		Drape	X X	Polyester Poplin	Laser Cut	✓	Machine		X	X
Outdoor Fitted	25		X X		Fitted		600 Denier Polyester	Serged	✓	Machine			X
Premium ★	18		X X		Drape		Two-Way Stretch Fabric	Hemmed	✓	Machine			X
Stain-Resistant	23		X X		Drape	X X	Polyester Poplin	Serged	✓	Machine	X		
Standard ★	14	X X X X X			Drape		Polyester Poplin	Serged	✓	Machine		X	X
UltraFit Classic ★	20	X X X			Snug Fitted		Two-Way Stretch Fabric	Hemmed	✓	Machine			X
UltraFit Curve	20	X X X			Snug Fitted	X	Two-Way Stretch Fabric	Hemmed	✓	Machine			X
UltraFit Demo ★	21	X			Snug Fitted		Two-Way Stretch Fabric	Hemmed	✓	Machine			X
Value Lite	23		X X		Drape		Polyester Pongee	Serged		Disposable	X <small>(white imprint only)</small>		
ROUND	PG #	31.5" BAR 31.5" CAFE 3' 4' 5'											
Fitted Round	24	X			Fitted		Polyester Poplin	Serged	✓	Machine		X	X
Round	24	X X X X X			Drape		Polyester Poplin	Serged	✓	Machine			X
UltraFit Round ★	21	X			Snug Fitted		Two-Way Stretch Fabric	Hemmed	✓	Machine			X
PARTIAL COVERAGE	PG #	28" 57" 125" 149" 6'											
Lateral Runner	26		X X		Drape	Top & Partial Sides	Polyester Poplin	Serged	✓	Machine		X <small>(top only)</small>	X
LazerLine Runner	26	X X			Drape	Partial Front, Top & Back	Polyester Poplin	Laser Cut	✓	Machine		X	X
Standard Runner ★	27	X X			Drape	Partial Front, Top & Back	Polyester Poplin	Serged	✓	Machine		X	X
UltraFit Crossover	21			X	Snug Fitted	Partial 4-Sided	Two-Way Stretch Fabric	Hemmed	✓	Machine			X

NOTE: Flame-retardant certified in compliance with the National Fire Protection Association Standard No. 701.

28 STOCK THROW COLORS

LEMON ★ PMS 109	RED PMS 201	PURPLE PMS VIOLET	LIME GREEN PMS 375	★ indicates stock throw colors that closely align with our stock tent canopy colors. See page 98.
YELLOW PMS 1235	BURGUNDY PMS 504	AQUAMARINE PMS 2231	EMERALD ★ PMS 347	
MANGO PMS 1375	FLAMINGO PMS 1767	COBALT ★ PMS 7683	SHAMROCK PMS 361	
ORANGE PMS 1505	HOT PINK PMS 219	BLUEBERRY PMS 647	HUNTER GREEN PMS 350	
PEACH PMS 162	MULBERRY PMS 683	ROYAL BLUE PMS 661	HAZELNUT PMS 7575	
CHERRY ★ PMS 1795	GRAPE PMS 268	NAVY BLUE ★ PMS 2767	BROWN PMS 476	
			WHITE ★	
			GRAY PMS 422	
			CHARCOAL PMS 425	
			BLACK ★	

PMS colors are for reference only and may vary slightly from actual color.



PRINT OPTIONS



Full-Color Imprint

- Simple to complex graphics (see product pages for details)
- Vector art required; imprinted on front only
- Available in limited stock fabric colors only
- Min. and max. artwork size requirements apply
- Always roll your table throw for storage; do not fold



Full-Color Front Only

- Simple to complex graphics
- Vector and raster art accepted; imprinted on front only
- Available in stock fabric colors only
- Maximum artwork size requirements apply
- Large maximum imprint area for more graphic coverage
- Fold and store in included poly bag



Full-Color Full-Bleed

- Simple, complex and photographic graphics
- Vector and raster art accepted
- Art is dye sublimated on white fabric only
- Full-color artwork can be printed across the entire throw
- No artwork size requirements
- Fold and store in included poly bag

TOP SELLER

POLYESTER POPLIN



Lightweight and durable; our most popular fabric choice.

TWO-WAY STRETCH FABRIC



Nearly opaque with a luxurious look and a high-class hemmed finish.

POLYESTER PONGEE



Lightweight and designed for limited use.

600 DENIER POLYESTER

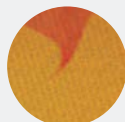

The same durable, weather-resistant material we use for our tent canopies.

BIODEGRADABLE FABRIC



Biodegradable fabric is made with CiCLO® technology.

RECYCLED POLYESTER KNIT

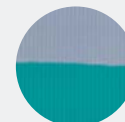

100% recycled media is made from REPREVE® fibers.

ANTIMICROBIAL POLYESTER KNIT

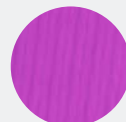

Heavyweight media that inhibits the growth of bacteria and the spreading of germs.

THROW MEDIA

Suggested Uses

- Event Check-Ins
- Fundraisers
- Career Fairs
- Trade Shows

ECONOMY TABLE THROW

The open-back design of this throw gives you legroom and quick access to anything you store beneath the table.

- Offers a large maximum imprint area for more graphic coverage on full-color front only throws
- Draped corners
- Polyester poplin
- Machine-washable and wrinkle-resistant
- Flame retardant certified for exhibit hall use



Front view

6' full-color full-bleed

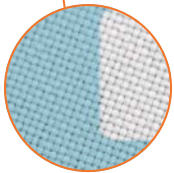

Wrinkle-resistant, durable polyester poplin.



Back view



Covers three sides of the table with a 9" overhang in back.



TABLE CLAMPS

Securely fasten your table cover to the table with these convenient clamps.

- Set of four
- Constructed of stainless steel

Table Clamps

Item #	Description	1	2-5	6-11	12-24
240779	Table Clamps (Set of 4)	5.20	5.00	4.90	4.70

USD MSRP (C)





16' shown with full-color full-bleed



Full-Color Front Only

Item #	Description	1	2-5	6-11	12-24
106045	4' Economy Throw	163.60	142.30	134.20	122.70
106002	6' Economy Throw	229.00	199.20	187.80	171.80
106014	8' Economy Throw	254.25	221.25	208.50	190.75
106051	12' Economy Throw	458.00	398.50	375.50	343.50
106053	16' Economy Throw	508.50	442.50	417.00	381.50

Stock fabric colors with full-color artwork printed on front. USD MSRP (C)
 Artwork cannot exceed maximum size requirements.

Description	Table Size	Front Only Graphic Size	Product Wt.
4'	48"W x 29"H x 29.75"D	40"W x 25"H	1.25 lbs.
6'	72"W x 29"H x 29.75"D	64"W x 25"H	2 lbs.
8'	96"W x 29"H x 29.75"D	64"W x 25"H	2.5 lbs.
12'	144"W x 29"H x 29.75"D	128"W x 25"H	3.2 lbs.
16'	192"W x 29"H x 29.75"D	128"W x 25"H	4.5 lbs.



8' full-color front only shown in gray



6' full-color front only shown in navy blue

Full-Color Full-Bleed

Item #	Description	1	2-5	6-11	12-24
106042	4' Economy Throw	163.60	142.30	134.20	122.70
106010	6' Economy Throw	229.00	199.20	187.80	171.80
106022	8' Economy Throw	254.25	221.25	208.50	190.75
106052	12' Economy Throw	458.00	398.50	375.50	343.50
106054	16' Economy Throw	508.50	442.50	417.00	381.50

White fabric fully dye sublimated with full-color artwork. USD MSRP (C)

Description	Table Size	Full-Bleed Graphic Size	Product Wt.
4'	48"W x 29"H x 29.75"D	View Online Template	1.25 lbs.
6'	72"W x 29"H x 29.75"D	View Online Template	2 lbs.
8'	96"W x 29"H x 29.75"D	View Online Template	2.5 lbs.
12'	144"W x 29"H x 29.75"D	View Online Template	3.2 lbs.
16'	192"W x 29"H x 29.75"D	View Online Template	4.5 lbs.



8' full-color full-bleed



6' full-color full-bleed

HARDWARE-ONLY LEAD TIME: SHIPS SAME DAY WHEN ORDERED BEFORE 2 PM CENTRAL

Prices are subject to change; visit our website for the most current pricing.
 Setup fee: \$20.00(G).
 See pages 208-211 for additional information that may apply to your order.

AFTER FINAL PROOF APPROVAL
 PRODUCTION LEAD TIME IS
2 DAYS

STANDARD TABLE THROW

Our most popular table throw is elegant in its simplicity.

- Covers four sides of the table, viewable from all sides
- Offers a large maximum imprint area for more graphic coverage on full-color front only throws
- Draped corners
- Polyester poplin
- Machine-washable and wrinkle-resistant
- Flame retardant certified for exhibit hall use



Front view

6' full-color full-bleed

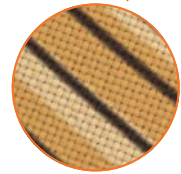

Wrinkle-resistant, durable polyester poplin.



Keep your supplies and accessories out of sight.

Back view

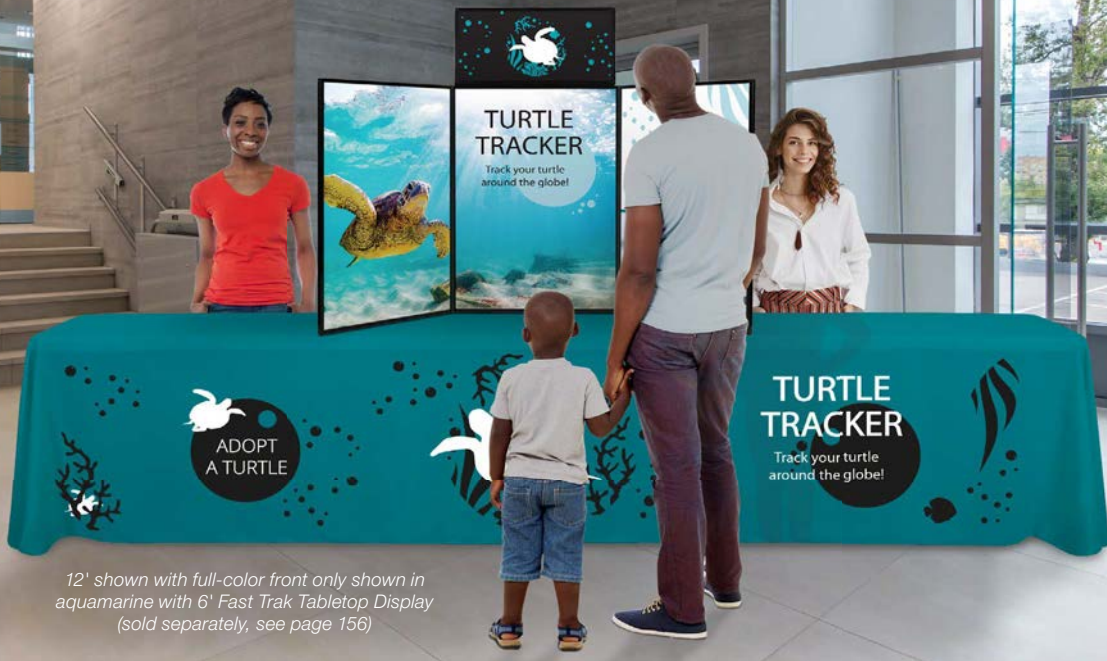

12' shown with full-color front only shown in aquamarine with 6' Fast Trak Tabletop Display (sold separately, see page 156)



Full-Color Front Only

Item #	Description	1	2-5	6-11	12-24
109105	4' Standard Throw	176.20	153.30	144.50	132.20
109002	6' Standard Throw	254.25	221.25	208.50	190.75
109014	8' Standard Throw	279.25	243.00	229.00	209.50
109100	12' Standard Throw	508.50	442.50	417.00	381.50
109102	16' Standard Throw	559.00	486.50	458.50	419.50

Stock fabric colors with full-color artwork printed on front. USD MSRP (C)
 Artwork cannot exceed maximum size requirements.

Description	Table Size	Front Only Graphic Size	Product Wt.
4'	48"W x 29"H x 29.75"D	40"W x 25"H	1.5 lbs.
6'	72"W x 29"H x 29.75"D	64"W x 25"H	2.5 lbs.
8'	96"W x 29"H x 29.75"D	64"W x 25"H	3 lbs.
12'	144"W x 29"H x 29.75"D	128"W x 25"H	4 lbs.
16'	192"W x 29"H x 29.75"D	128"W x 25"H	5 lbs.



8' full-color front only shown in hunter green



6' full-color front only shown in royal blue

Full-Color Full-Bleed

Item #	Description	1	2-5	6-11	12-24
109106	4' Standard Throw	176.20	153.30	144.50	132.20
109010	6' Standard Throw	254.25	221.25	208.50	190.75
109022	8' Standard Throw	279.25	243.00	229.00	209.50
109101	12' Standard Throw	508.50	442.50	417.00	381.50
109103	16' Standard Throw	559.00	486.50	458.50	419.50

White fabric fully dye sublimated with full-color artwork. USD MSRP (C)

Description	Table Size	Full-Bleed Graphic Size	Product Wt.
4'	48"W x 29"H x 29.75"D	View Online Template	1.5 lbs.
6'	72"W x 29"H x 29.75"D	View Online Template	2.5 lbs.
8'	96"W x 29"H x 29.75"D	View Online Template	3 lbs.
12'	144"W x 29"H x 29.75"D	View Online Template	4 lbs.
16'	192"W x 29"H x 29.75"D	View Online Template	5 lbs.



8' full-color full-bleed



6' full-color full-bleed

Prices are subject to change; visit our website for the most current pricing.
 Setup fee: \$20.00(G).
 See pages 208-211 for additional information that may apply to your order.

AFTER FINAL PROOF APPROVAL
 PRODUCTION LEAD TIME IS
2DAYS

8' full-color full-bleed transforms into a 6' fitted



Converts from 8' to 6' and Back Again!



1. Grab the back corner of the table throw.

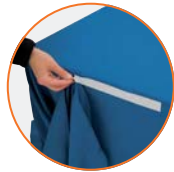

2. Attach the corner to the back of the throw using the built-in hook-and-loop fasteners.



3. Grab the front corner of the throw and fold it tightly around the back corner of the table.



4. Secure it in place with the built-in hook-and-loop fasteners.



CONVERTIBLE TABLE THROW

This throw is easily convertible so it fits both 8' and 6' table sizes.

- Offers a large maximum imprint area for more graphic coverage on full-color front only throws
- Hook-and-loop fasteners make size conversion quick and easy; available in black or white (see website for details)
- Covers four sides of the table
- Polyester poplin
- Machine-washable and wrinkle-resistant
- Flame retardant certified for exhibit hall use



8' full-color front only shown in cobalt



8' full-color full-bleed

Full-Color Front Only

Item #	Description	1	2-5	6-11	12-24
104014	6'x8' Convertible Throw	320.75	279.00	263.00	240.50

Stock fabric colors with full-color artwork printed on front. USD MSRP (C)
Artwork cannot exceed maximum size requirements.

Full-Color Full-Bleed

Item #	Description	1	2-5	6-11	12-24
104022	6'x8' Convertible Throw	320.75	279.00	263.00	240.50

White fabric fully dye sublimated with full-color artwork. USD MSRP (C)

Table Size	Front Only Graphic Size	Full-Bleed Graphic Size	Product Wt.
72"/96"W x 29"H x 29.75"D	64"W x 25"H	View Online Template	3 lbs.

AFTER FINAL PROOF APPROVAL
PRODUCTION LEAD TIME IS
2DAYS

Prices are subject to change; visit our website for the most current pricing.
Setup fee: \$20.00(G).
See pages 208-211 for additional information that may apply to your order.

Suggested Uses

- Promotions
- Charity Events
- Hotels
- School Functions



8' full-color full-bleed



6' full-color front only shown in royal blue

LAZERLINE THROW

These cost-effective throws are laser-cut for a crisp finished edge.

- Available in full-color front only and full-color full-bleed
- Heat-treated edges will not fray or unravel
- Available in 3-sided or 4-sided throw styles
- Polyester poplin
- Machine-washable and wrinkle-resistant
- Flame retardant certified for exhibit hall use

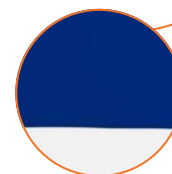

Laser-cut edges for a clean look.



Full-Color Front Only

Item #	Description	1	2-5	6-11	12-24
108213	6' LazerLine 3-Sided Throw	170.60	148.40	139.90	128.00
108214	8' LazerLine 3-Sided Throw	189.30	164.70	155.20	142.00
108201	6' LazerLine 4-Sided Throw	189.30	164.70	155.20	142.00
108202	8' LazerLine 4-Sided Throw	208.00	181.00	170.60	156.00

Stock fabric colors with full-color artwork printed on front. USD MSRP (C)
Artwork cannot exceed maximum size requirements.

Description	Table Size	Front Only Graphic Size	Product Wt. (3-Sided / 4-Sided)
6'	72"W x 29"H x 29.75"D	64"W x 25"H	2 lbs. / 2.5 lbs.
8'	96"W x 29"H x 29.75"D	64"W x 25"H	2.5 lbs. / 3 lbs.

Full-Color Full-Bleed

Item #	Description	1	2-5	6-11	12-24
108216	6' LazerLine 3-Sided Throw	170.60	148.40	139.90	128.00
108217	8' LazerLine 3-Sided Throw	189.30	164.70	155.20	142.00
108204	6' LazerLine 4-Sided Throw	189.30	164.70	155.20	142.00
108205	8' LazerLine 4-Sided Throw	208.00	181.00	170.60	156.00

White fabric fully dye sublimated with full-color artwork. USD MSRP (C)

Description	Table Size	Full-Bleed Graphic Size	Product Wt. (3-Sided / 4-Sided)
6'	72"W x 29"H x 29.75"D	View Online Template	2 lbs. / 2.5 lbs.
8'	96"W x 29"H x 29.75"D	View Online Template	2.5 lbs. / 3 lbs.



4-sided table throws offer full coverage on all sides of the table.



3-sided table throws have a 9" overhang in the back to keep the throw from slipping off the table.

Prices are subject to change; visit our website for the most current pricing.
Setup fee: \$20.00(G).
See pages 208-211 for additional information that may apply to your order.

AFTER FINAL PROOF APPROVAL
PRODUCTION LEAD TIME IS
2 DAYS

Suggested Uses

- Trade Shows
- Product Demos
- Meetings
- Sales Kits



Finished with a hemmed edge.



PREMIUM TABLE THROW

Premium throws are perfect for showcasing eye-catching, full-color imagery with an upscale look.

- Covers four sides of the table
- Draped corners
- Nearly opaque material
- Artwork is dye sublimated on two-way stretch fabric
- Machine-washable
- Flame retardant certified for exhibit hall use



Full-Color Full-Bleed

Item #	Description	1	2-5	6-11	12-24
109070	6' Premium Throw	566.50	515.50	493.00	464.50
109071	8' Premium Throw	598.00	544.00	520.50	490.50

White fabric fully dye sublimated with full-color artwork. USD MSRP (C)

Description	Table Size	Full-Bleed Graphic Size	Product Wt.
6'	72"W x 29"H x 29.75"D	View Online Template	3.5 lbs.
8'	96"W x 29"H x 29.75"D	View Online Template	4.75 lbs.

AFTER FINAL PROOF APPROVAL
PRODUCTION LEAD TIME IS
2DAYS

Prices are subject to change; visit our website for the most current pricing.
Setup fee: \$20.00(G).
See pages 208-211 for additional information that may apply to your order.

Suggested Uses

- Sporting Events
- School Productions
- Corporate Events
- Retail Stores



ECO-WISE TABLE THROW

Change up your regular table throw with this eco-friendly version!

- Artwork is dye sublimated on biodegradable media which is CiCLO® treated polyester fabric
- CiCLO® treated fabric allows the polyester to biodegrade 91.1% compared to untreated polyester
- Available in 3-sided or 4-sided throw styles
- Draped corners
- Machine-washable
- Flame retardant certified for exhibit hall use



8'



6'

Full-Color Full-Bleed

Item #	Description	1	2-5	6-11	12-24
108271	6' Eco-Wise 3-Sided Throw	377.50	328.50	309.50	283.25
108272	8' Eco-Wise 3-Sided Throw	415.25	361.25	340.50	311.50
108274	6' Eco-Wise 4-Sided Throw	402.75	350.50	330.25	302.00
108275	8' Eco-Wise 4-Sided Throw	440.50	383.25	361.25	330.50

Biodegradable white fabric fully dye sublimated with full-color artwork. USD MSRP (C)

Description	Table Size	Full-Bleed Graphic Size	Product Wt. (3-Sided / 4-Sided)
6'	72"W x 29"H x 29.75"D	View Online Template	2.8 lbs. / 3.4 lbs.
8'	96"W x 29"H x 29.75"D	View Online Template	3.8 lbs. / 4.6 lbs.



CiCLO® is a sustainable textile additive that allows synthetic media to break down at a rate similar to natural fibers.

Suggested Uses

- Registrations
- Trade Shows
- Zoos
- Presentations



ENVIRO PRO TABLE THROW

This premium 100% recycled table throw showcases our softest and most wrinkle-resistant material yet!

- Artwork is vibrantly dye sublimated on recycled polyester knit
- 100% recycled media is made with REPREEVE® fibers
- Soft to the touch and wrinkle-resistant
- Available in 3-sided or 4-sided throw styles
- Machine-washable
- Flame retardant certified for exhibit hall use



Full-Color Full-Bleed

Item #	Description	1	2-5	6-11	12-24
108240	6' Enviro Pro 3-Sided Throw	325.00	295.75	282.75	266.50
108242	8' Enviro Pro 3-Sided Throw	365.00	332.25	317.50	299.25
108241	6' Enviro Pro 4-Sided Throw	350.00	318.50	304.50	287.00
108243	8' Enviro Pro 4-Sided Throw	390.00	355.00	339.25	319.75

100% recycled white fabric fully dye sublimated with full-color artwork. USD MSRP (C)

Description	Table Size	Full-Bleed Graphic Size	Product Wt. (3-Sided / 4-Sided)
6'	72"W x 29"H x 29.75"D	View Online Template	2.2 lbs. / 2.8 lbs.
8'	96"W x 29"H x 29.75"D	View Online Template	2.6 lbs. / 3.2 lbs.

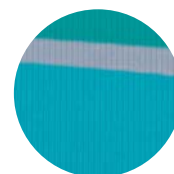

Sustainable recycled polyester knit is made with REPREEVE® fibers recycled from plastic bottles.

Prices are subject to change; visit our website for the most current pricing.
Setup fee: \$20.00(G).
See pages 208-211 for additional information that may apply to your order.

AFTER FINAL PROOF APPROVAL
PRODUCTION LEAD TIME IS
2 DAYS

Suggested Uses

- Trade Shows
- In-Store Displays
- Sidewalk Sales
- Presentations

ULTRAFIT TABLE THROW

This form-fitting throw is an attractive option for promoting your brand. It stretches to fit tightly around tables, creating a crisp, refined appearance.

- Tight, form-fitting look
- Artwork is dye sublimated on two-way stretch fabric
- Machine-washable and wrinkle-resistant
- Flame retardant certified for exhibit hall use

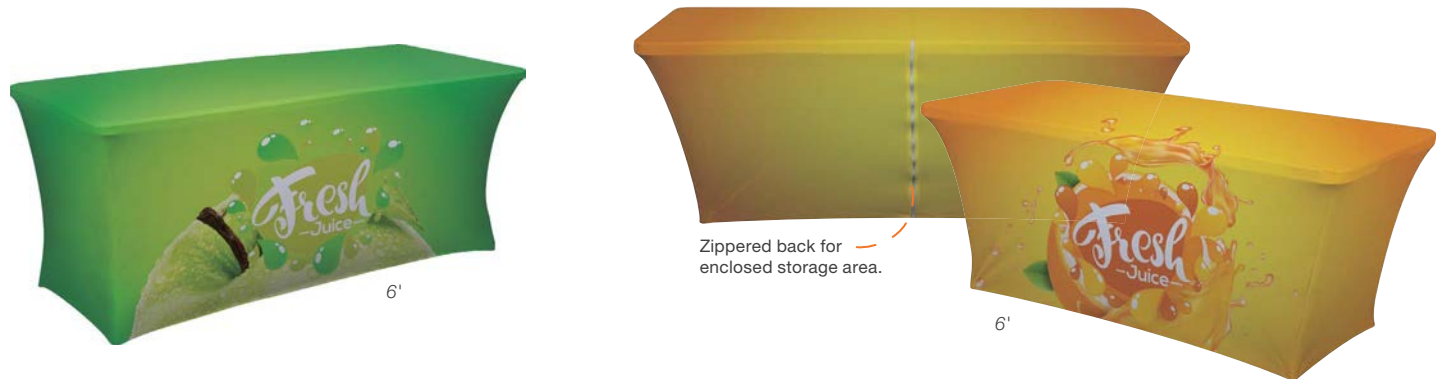

UltraFit Curve

Item #	Description	1	2-5	6-11	12-24
114032	4' Full-Color Full-Bleed	315.00	286.75	274.00	258.25
114015	6' Full-Color Full-Bleed	450.00	409.50	391.50	369.00
114018	8' Full-Color Full-Bleed	499.50	454.50	434.50	409.50

White fabric fully dye sublimated with full-color artwork. USD MSRP (C)

Description	Table Size	Full-Bleed Graphic Size	Product Wt.
4'	48"W x 29"H x 29.75"D	View Online Template	1.3 lbs.
6'	72"W x 29"H x 29.75"D	View Online Template	2.25 lbs.
8'	96"W x 29"H x 29.75"D	View Online Template	2.75 lbs.

UltraFit Classic

Item #	Description	1	2-5	6-11	12-24
114034	4' Full-Color Full-Bleed	355.75	323.75	309.50	291.75
114002	6' Full-Color Full-Bleed	475.00	432.25	413.25	389.50
114005	8' Full-Color Full-Bleed	527.50	480.00	459.00	432.50

White fabric fully dye sublimated with full-color artwork. USD MSRP (C)

Description	Table Size	Full-Bleed Graphic Size	Product Wt.
4'	48"W x 29"H x 29.75"D	View Online Template	1.75 lbs.
6'	72"W x 29"H x 29.75"D	View Online Template	2.5 lbs.
8'	96"W x 29"H x 29.75"D	View Online Template	3 lbs.



Zippered back for enclosed storage area.

UltraFit Round

Item #	Description	1	2-5	6-11	12-24
114012	31.5" Bar-Height Full-Color Full-Bleed	388.75	353.75	338.25	318.75
White fabric fully dye sublimated with full-color artwork.				USD MSRP (C)	

Table Size
43"H x 31.5"D

Full-Bleed Graphic Size
View Online Template

Product Wt.
1.75 lbs.

UltraFit Demo

Item #	Description	1	2-5	6-11	12-24
114100	4' Full-Color Full-Bleed	403.75	367.50	351.25	331.00
White fabric fully dye sublimated with full-color artwork.				USD MSRP (C)	

Table Size
47.75"W x 36"H x 24"D

Full-Bleed Graphic Size
View Online Template

Product Wt.
2 lbs.



Create alternate looks based on which design is on top.

UltraFit Crossover

Item #	Description	1	2-5	6-11	12-24
109090	6' Full-Color Full-Bleed	459.00	417.75	399.25	376.50
White fabric fully dye sublimated with full-color artwork.				USD MSRP (C)	

Table Size
72"W x 29"H x 29.75"D

Full-Bleed Graphic Size
View Online Template

Product Wt.
3 lbs.



Best Fits

31.5" Round Table Throws
Fits on tables: 43"H x 31.5"D

4' Demo Table Throws
Fits on tables: 47.75"W x 36"H x 24"D

4' Classic & Curve Table Throws
Fits on tables: 48"W x 29"H x 29.75"D

6' Classic & Curve Table Throws
Fits on tables: 72"W x 29"H x 29.75"D

8' Classic & Curve Table Throws
Fits on tables: 96"W x 29"H x 29.75"D



Prices are subject to change; visit our website for the most current pricing.
Setup fee: \$20.00(G).
See pages 208-211 for additional information that may apply to your order.

AFTER FINAL PROOF APPROVAL
PRODUCTION LEAD TIME IS
4 DAYS

Suggested Uses

- School Events
- Trade Shows
- Medical Sites
- Youth Programs



Material is treated with an antimicrobial coating from Sanitized®.

Finished with a hemmed edge.

ANTIMICROBIAL TABLE THROW

Add extra protection to your table and let the good times roll!

- Heavyweight media that inhibits the growth of bacteria and the spreading of germs
- Artwork is dye sublimated on 8 oz. antimicrobial heavyweight polyester knit
- Available in 3-sided or 4-sided throw styles
- Draped corners
- Machine-washable and wrinkle-resistant
- Flame retardant certified for exhibit hall use



Full-Color Full-Bleed

Item #	Description	1	2-5	6-11	12-24
108260	4' Antimicrobial 3-Sided Throw	277.00	241.00	227.25	207.75
108261	6' Antimicrobial 3-Sided Throw	365.00	317.50	299.25	273.75
108262	8' Antimicrobial 3-Sided Throw	503.50	438.00	413.00	377.50
108263	4' Antimicrobial 4-Sided Throw	327.00	284.50	268.25	245.25
108264	6' Antimicrobial 4-Sided Throw	415.25	361.25	340.50	311.50
108265	8' Antimicrobial 4-Sided Throw	554.00	482.00	454.50	415.50

White fabric fully dye sublimated with full-color artwork. USD MSRP (C)

Description	Table Size	Imprint Graphic Size	Product Wt. (3-Sided / 4-Sided)
4'	48"W x 29"H x 29.75"D	View Online Template	2 lbs. / 2.4 lbs.
6'	72"W x 29"H x 29.75"D	View Online Template	3 lbs. / 3.6 lbs.
8'	96"W x 29"H x 29.75"D	View Online Template	4 lbs. / 4.8 lbs.



AFTER FINAL PROOF APPROVAL
PRODUCTION LEAD TIME IS
2DAYS

Prices are subject to change; visit our website for the most current pricing.

Setup fee: \$20.00(G).

See pages 208-211 for additional information that may apply to your order.

STAIN-RESISTANT TABLE THROW

Don't stress over the occasional spill. This table throw features a stain-resistant treatment that repels liquids instead of absorbing them.

- Available in 3-sided or 4-sided throw styles
- Draped corners
- Stain-resistant polyester poplin
- Machine-washable and wrinkle-resistant
- Flame retardant certified for exhibit hall use
- Unimprinted throws available online



8' shown in purple



6' shown in burgundy

Full-Color Imprint

Item #	Description	1	2-5	6-11	12-24
114125	6' Stain-Resistant 3-Sided Throw	254.25	221.25	208.50	190.75
114127	8' Stain-Resistant 3-Sided Throw	279.25	243.00	229.00	209.50
114121	6' Stain-Resistant 4-Sided Throw	279.25	243.00	229.00	209.50
114123	8' Stain-Resistant 4-Sided Throw	304.50	265.00	249.75	228.50

Stock stain-resistant fabric colors imprinted with any color(s). USD MSRP (C)

Description	Table Size	Imprint Graphic Size	Product Wt. (3-Sided / 4-Sided)
6'	72"W x 29"H x 29.75"D	50"W x 17"H	2 lbs. / 2.5 lbs.
8'	96"W x 29"H x 29.75"D	50"W x 17"H	2.5 lbs. / 3 lbs.



3-sided table throws have a 9" overhang in the back to keep the throw from slipping off the table.



4-sided table throws offer full coverage on all sides of the table.

STOCK STAIN-RESISTANT THROW COLORS

- Black
 - Blueberry PMS 647
 - Brown PMS 476
 - Burgundy PMS 504
 - Charcoal PMS 425
 - Gray PMS 422
 - Hunter Green PMS 350
 - Lime Green PMS 375
 - Navy Blue PMS 2767
 - Orange PMS 1505
 - Purple PMS Violet
 - Red PMS 201
 - Royal Blue PMS 661
 - White
 - Yellow PMS 1235
- PMS colors are for reference only and may vary slightly from actual color.

VALUE LITE TABLE THROW

Value Lite table throws provide a cost-effective option for simple white logo designs.

- Covers four sides of the table
- Draped corners
- Available in five stock fabric colors; white imprint only
- Short-term use
- Minimum order quantity of 12
- Unimprinted throws available online



White Imprint

Item #	Description	12-24	25-49	50-74	75-99
116005	6' with White Imprint	118.40	111.30	105.40	92.40
116008	8' with White Imprint	124.60	117.10	110.90	97.20

Stock fabric colors imprinted with white imprint only. Minimum order quantity of 12. USD MSRP (C)

Description	Table Size	Imprint Graphic Size	Product Wt.
6'	72"W x 29"H x 29.75"D	50"W x 17"H	15 lbs. (Qty 12)
8'	96"W x 29"H x 29.75"D	50"W x 17"H	18 lbs. (Qty 12)

STOCK VALUE LITE THROW COLORS

- Black
 - Hunter Green PMS 350
 - Navy Blue PMS 2767
 - Red PMS 201
 - Royal Blue PMS 661
- PMS colors are for reference only and may vary slightly from actual color.



8' shown in black



6' shown in red

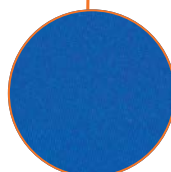

Lightweight, 100% woven polyester pongee.

Prices are subject to change; visit our website for the most current pricing. Setup fee: \$20.00(G). See pages 208-211 for additional information that may apply to your order.

STAIN-RESISTANT VALUE
3 OF **7** DAYS
 AFTER FINAL PROOF APPROVAL
 PRODUCTION LEAD TIME IS



ROUND TABLE THROW

Whether you're showcasing products or hosting a banquet, this table throw adds style to any occasion.

- Draped, seamless look
- Artwork is dye sublimated on polyester poplin
- Machine-washable and wrinkle-resistant
- Flame retardant certified for exhibit hall use



Full-Color Full-Bleed

Item #	Description	1	2-5	6-11	12-24
114040	31.5" Café-Height Round Throw	281.75	256.50	245.00	231.00
114041	31.5" Bar-Height Round Throw	304.50	277.00	265.00	249.75
114042	3' Round Throw	281.75	256.50	245.00	231.00
114043	4' Round Throw	304.50	277.00	265.00	249.75
114044	5' Round Throw	304.50	277.00	265.00	249.75

White fabric fully dye sublimated with full-color artwork. USD MSRP (C)

Description	Table Size	Overhang	Full-Bleed Graphic Size	Product Wt.
31.5" Café-Height	28"H x 31.5"D	27"	View Online Template	1.25 lbs.
31.5" Bar-Height	43"H x 31.5"D	33.25"	View Online Template	1.75 lbs.
3'	28"H x 36"D	27"	View Online Template	1.5 lbs.
4'	28"H x 48"D	25"	View Online Template	1.75 lbs.
5'	28"H x 60"D	19"	View Online Template	1.75 lbs.

31.5" bar-height

31.5" café-height



Full-color full-bleed

Full-color front only shown in blueberry



FITTED ROUND TABLE THROW

This fitted table throw has a crisp, well-defined shape that makes a big impression at events.

- Fitted for round tables
- Polyester poplin
- Machine-washable and wrinkle-resistant
- Flame retardant certified for exhibit hall use



Full-Color Front Only

Item #	Description	1	2-5	6-11	12-24
107040	31.5" Bar-Height Fitted Round Throw	177.40	154.30	145.50	133.10

Stock fabric colors with full-color artwork printed on front. USD MSRP (C)
Artwork cannot exceed maximum size requirements.

Full-Color Full-Bleed

Item #	Description	1	2-5	6-11	12-24
107047	31.5" Bar-Height Fitted Round Throw	177.40	154.30	145.50	133.10

White fabric fully dye sublimated with full-color artwork. USD MSRP (C)

Table Size	Front Only Graphic Size	Viewable Area	Full-Bleed Graphic Size	Product Wt.
43"H x 31.5"D	40"W x 17"H	24"W x 17"H	View Online Template	1.5 lbs.

ROUND | FITTED ROUND
AFTER FINAL PROOF APPROVAL
PRODUCTION LEAD TIME IS
2 or 3 DAYS

Prices are subject to change; visit our website for the most current pricing.
Setup fee: \$20.00(G).
See pages 208-211 for additional information that may apply to your order.

Suggested Uses

- Career Fairs
- College Recruiting
- Registration
- Promotional Events

FITTED TABLE THROW

This throw is designed to fit snugly around tables. Its taut surfaces and sharp lines give it a tailored look that stands out at meetings, shows, career fairs and more.

- Tight, fitted look
- Covers four sides of the table
- Polyester poplin
- Machine-washable and wrinkle-resistant
- Flame retardant certified for exhibit hall use



8' full-color full-bleed



6' full-color front only shown in black

TABLE COVERS

Full-Color Front Only

Item #	Description	1	2-5	6-11	12-24
115002	4' Fitted Demo Throw	227.80	198.20	186.80	170.90
107002	6' Fitted Throw	279.25	243.00	229.00	209.50
107014	8' Fitted Throw	304.50	265.00	249.75	228.50

Stock fabric colors with full-color artwork printed on front. USD MSRP (C)
Artwork cannot exceed maximum size requirements.

Full-Color Full-Bleed

Item #	Description	1	2-5	6-11	12-24
115009	4' Fitted Demo Throw	227.80	198.20	186.80	170.90
107010	6' Fitted Throw	279.25	243.00	229.00	209.50
107022	8' Fitted Throw	304.50	265.00	249.75	228.50

White fabric fully dye sublimated with full-color artwork. USD MSRP (C)

Description	Table Size	Front Only Graphic Size	Full-Bleed Graphic Size	Product Wt.
4'	48"W x 36"H x 24"D	42"W x 17"H	View Online Template	1.5 lbs.
6'	72"W x 29"H x 29.75"D	64"W x 25"H	View Online Template	2 lbs.
8'	96"W x 29"H x 29.75"D	64"W x 25"H	View Online Template	2.5 lbs.



OUTDOOR FITTED TABLE THROW

This heavy-duty throw can handle wind and spills, making it a perfect choice for outdoor events.

- Stays on the table, even in wind
- Covers four sides of the table
- Artwork is dye sublimated on 600 denier polyester
- Machine-washable
- Flame retardant certified for exhibit hall use



See page 211 for more information on wind ratings.

Full-Color Full-Bleed

Item #	Description	1	2-5	6-11	12-24
107060	6' Outdoor Fitted Throw	415.25	361.25	340.50	311.50
107061	8' Outdoor Fitted Throw	465.75	423.75	405.25	382.00

White fabric fully dye sublimated with full-color artwork. USD MSRP (C)

Description	Table Size	Full-Bleed Graphic Size	Product Wt.
6'	72"W x 29"H x 29.75"D	View Online Template	3.2 lbs.
8'	96"W x 29"H x 29.75"D	View Online Template	4.2 lbs.



8'



6'

Prices are subject to change; visit our website for the most current pricing.
Setup fee: \$20.00(G).
See pages 208-211 for additional information that may apply to your order.

AFTER FINAL PROOF APPROVAL
PRODUCTION LEAD TIME IS
3 DAYS



28" full-color front only shown in white



57" full-color full-bleed



12"



Laser-cut edges for a clean look.

LAZERLINE RUNNER

These cost-effective runners are laser-cut for a crisp finished edge.

- Available in full-color front only and full-color full-bleed
- Heat-treated edges will not fray or unravel
- Polyester poplin
- Machine-washable and wrinkle-resistant
- Flame retardant certified for exhibit hall use
- Table throw sold separately



Full-Color Front Only

Item #	Description	1	2-5	6-11	12-24
108224	28" LazerLine Runner	122.70	111.70	103.10	93.30
108225	57" LazerLine Runner	151.80	138.10	127.50	115.40

Stock fabric colors with full-color artwork printed on front. USD MSRP (C)
Artwork cannot exceed maximum size requirements.

Description	Finished Size	Front Only Graphic Size	Product Wt.
28"	28"W x 80"D	24"W x 25"H	0.5 lb.
57"	57"W x 80"D	50"W x 25"H	1 lb.

Full-Color Full-Bleed

Item #	Description	1	2-5	6-11	12-24
271272	12" LazerLine Runner	104.00	90.50	85.30	78.00
108226	28" LazerLine Runner	122.70	111.70	103.10	93.30
271273	36" LazerLine Runner	135.20	117.60	110.90	101.40
108227	57" LazerLine Runner	151.80	138.10	127.50	115.40

White fabric fully dye sublimated with full-color artwork. USD MSRP (C)

Description	Finished Size	Full-Bleed Graphic Size	Product Wt.
12"	12"W x 72"D	View Online Template	0.25 lb.
28"	28"W x 80"D	View Online Template	0.5 lb.
36"	36"W x 72"D	View Online Template	0.5 lb.
57"	57"W x 80"D	View Online Template	1 lb.

LATERAL TABLE RUNNER

This runner drapes across the width of the table so it won't cover a design or logo printed on the front of your table throw.

- Polyester poplin
- Machine-washable and wrinkle-resistant
- Flame retardant certified for exhibit hall use
- Table throw sold separately



125" full-color top only runner shown in royal blue on a 6" Standard throw with full-color front only shown in black (sold separately; see page 14)



125" full-color top only shown in royal blue



125" full-color full-bleed

Full-Color Top Only

Item #	Description	1	2-5	6-11	12-24
105111	125" Lateral Runner	203.80	185.50	171.20	154.90
105116	149" Lateral Runner	241.60	219.90	202.90	183.60

Stock fabric colors imprinted with any color(s). USD MSRP (C)

Full-Color Full-Bleed

Item #	Description	1	2-5	6-11	12-24
105114	125" Lateral Runner	203.80	185.50	171.20	154.90
105119	149" Lateral Runner	241.60	219.90	202.90	183.60

White fabric fully dye sublimated with full-color artwork. USD MSRP (C)

Description	Finished Size	Top Only Graphic Size	Dye Sub Graphic Size	Product Wt.
125"	125"W x 28"D	50"W x 17"H	View Online Template	0.8 lb.
149"	149"W x 28"D	50"W x 17"H	View Online Template	1 lb.

STOCK LATERAL RUNNER COLORS

- Black
- Navy Blue PMS 2767
- Red PMS 201
- Royal Blue 661
- White

PMS colors are for reference only and may vary slightly from actual color.

AFTER FINAL PROOF APPROVAL
PRODUCTION LEAD TIME IS
2DAYS

Prices are subject to change; visit our website for the most current pricing.
Setup fee: \$20.00(G).
See pages 208-211 for additional information that may apply to your order.



57" full-color front only shown in mango



28" with full-color full-bleed

Add-On



Table Throw Messenger Bag
Item #220107. See Page 201.

STANDARD TABLE RUNNER

This stylish runner lets you add a logo or design to any table.

- Offers a large maximum imprint area for more graphic coverage for even more ad space on full-color front only runners
- Available in two widths
- Polyester poplin
- Machine-washable and wrinkle-resistant
- Flame retardant certified for exhibit hall use
- Table throw sold separately



28" full-color front only shown in white



28" full-color full-bleed

Full-Color Front Only

Item #	Description	1	2-5	6-11	12-24
102002	28" Standard Runner	164.80	150.00	138.40	125.20
102014	57" Standard Runner	203.80	185.50	171.20	154.90

Stock fabric colors with full-color artwork printed on front. USD MSRP (C)
Artwork cannot exceed maximum size requirements.

Full-Color Full-Bleed

Item #	Description	1	2-5	6-11	12-24
102010	28" Standard Runner	164.80	150.00	138.40	125.20
102022	57" Standard Runner	203.80	185.50	171.20	154.90

White fabric fully dye sublimated with full-color artwork. USD MSRP (C)

Description	Finished Size	Front Only Graphic Size	Full-Bleed Graphic Size	Product Wt.
28"	28"W x 80"D	24"W x 25"H	View Online Template	0.5 lb.
57"	57"W x 80"D	50"W x 25"H	View Online Template	1 lb.

Prices are subject to change; visit our website for the most current pricing.
Setup fee: \$20.00(G).
See pages 208-211 for additional information that may apply to your order.

AFTER FINAL PROOF APPROVAL
PRODUCTION LEAD TIME IS
2 DAYS

RETRACTABLE BANNERS

When choosing a retractor
have you considered...

- **USE** - Will this product be used on a floor or on a tabletop?
- **FLEXIBILITY** - Will your graphic be permanent or will you be swapping it out frequently?
- **FREQUENCY** - How often will your retractor be set up and taken down?
- **LOCATION** - Will your retractor be used indoors or outdoors?
- **MESSAGE** - Do you want a single- or double-sided display?



RETRACTABLE BANNER COMPARISON CHART

BEST SELLERS ★ SUSTAINABLE ◆	PG #	TABLETOP						FEATURES				BANNER MEDIA (NOT ALL MEDIA AVAILABLE FOR ALL SIZES)	RCAT RATING MINIMUM RETRACTIONS	HARDWARE WARRANTY	
		24"	31.5"	33.5"	36"	48"	TELESCOPING POLE	CHANGEABLE BANNER	ADJUSTABLE TENSION	2-SIDED OPTION					
GOOD															
Deluxe Mini ★	45	X											Polypropylene Media	-	6 months
Mini Promo ★	45	X											Polypropylene Media	-	6 months
NEW! Dual ◆	34			X	X	X						✓	No-Curl Hybrid Media - No-Curl Opaque Fabric PVC-Free Silver Backed Media	100	1 year
NEW! Economy ★ ◆	32	X	X	X	X	X	X						No-Curl Hybrid Media - No-Curl Opaque Fabric No-Curl Fabric (48" Only) - PVC-Free Silver Backed Media - Dry-Erase Media (Tabletop Only)	100	1 year
Ideal ★	30			X	X								Polypropylene Media	25	2 months
Value ★	31			X	X	X							Polypropylene Media - No-Curl Hybrid Media	50	6 months
BETTER															
		24"	31.5"	33.5"	36"	46.5"	48"	TELESCOPING POLE	CHANGEABLE BANNER	ADJUSTABLE TENSION	2-SIDED OPTION				
Deluxe Pro ★	35			X		X		✓	✓		✓		No-Curl Opaque Fabric - Dry-Erase Media	200	2 years
Economy Plus ★	38		X	X				✓	✓				No-Curl Hybrid Media - No-Curl Opaque Fabric - Dry-Erase Media	150	2 years
NEW! Stratus ★ ◆	36	X	X	X	X		X	✓	✓				No-Curl Hybrid Media No-Curl Opaque Fabric - Dry-Erase Media PVC-Free Silver Backed Media	200	2 years
BEST															
		16"	31.25"	33.5"	40"	60"		TELESCOPING POLE	CHANGEABLE BANNER	ADJUSTABLE TENSION	2-SIDED OPTION				
InstaChange	39			X	X			✓	✓				No-Curl Opaque Fabric	600	2 years
MagnaLink	41	X		X		X		✓	✓	✓			No-Curl Fabric	800	3 years
Spotlight ★	40		X										Flexible Backlit Film	800	3 years
Superb	41			X				✓	✓	✓			No-Curl Hybrid Media	800	Lifetime
SPECIALTY															
		31"	33.25"	5'	6'	8'		TELESCOPING POLE	CHANGEABLE BANNER	ADJUSTABLE TENSION	2-SIDED OPTION				
Eco-Lite ◆	43	X											Paper-Based Media	-	30 days
Element	42		X					✓			✓		13 oz. Scrim Vinyl	150	1 year
Jumbo Wide ★	44			X	X	X							13 oz. Scrim Smooth Vinyl - No-Curl Fabric	100	1 year
Outdoor Trek Lite	42		X								✓		13 oz. Scrim Vinyl	250	1 year

3-29 Beaufort Wind Rating: Select products have been rated on the Beaufort Wind Scale. See rating icon underneath the product name. Wind ratings were determined utilizing all available securing/stabilizing options sold with or offered for the product. Review the Beaufort Scale on page 211 for additional details.



AMERICA'S FINEST RETRACTOR

To guarantee superior quality, we have developed an RCAT (Retractor Calibration Assessment Test) machine that assesses retractable banner components. Each retractor is tested and rated to a minimum number of times it will extend and retract with normal use, helping you find a retractor that meets your exact needs. The RCAT rating certification lets you have confidence in your retractable banner display, no matter which one you choose.



TOP SELLER

BANNER MEDIA

TITAN™ NO-CURL HYBRID MEDIA



Anti-curl properties for a taut banner.

TITAN™ NO-CURL OPAQUE FABRIC



High-quality fabric that prevents curling. Silver backing makes it opaque.

TITAN™ 13 OZ. SCRIM VINYL

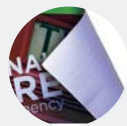

Durable vinyl repels water and cleans easily for extended outdoor use.

TITAN™ NO-CURL FABRIC



Lightweight, no-glare fabric prevents curling.

PVC-FREE SILVER BACKED MEDIA

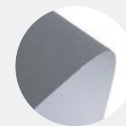

This media is an alternative to traditional vinyl as it does not contain polyvinyl (PVC).

TITAN™ 13 OZ. SMOOTH SCRIM VINYL



Smooth vinyl material, ideal for high-quality graphics.



DRY-ERASE MEDIA
Smooth, glossy surface that can be written or drawn on with a dry-erase marker.



TITAN™ POLYPROPYLENE MEDIA
Tear-resistant matte media for temporary use.



BACKLIT FILM
Backlit film allows for light to shine through your artwork.

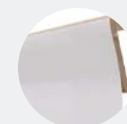

PAPER-BASED MEDIA
Cellulose-based poster paper perfect for sustainable displays.



33.5"

31.5"



IDEAL RETRACTOR

The Ideal Retractor is designed from the ground up to be a quick, simple solution for short-term promotional applications.

- Lightweight, portable base
- Three-section shock cord pole
- Artwork is printed on tear-resistant Titan™ polypropylene media



Ideal Retractor

Item #	Description	1	2-5	6-11	12-24
261150	31.5" Kit	134.90	126.90	121.40	113.30
261153	33.5" Kit	148.00	139.10	133.20	124.30
Kit Includes: Hardware, Installed Graphic and Soft Carry Case					USD MSRP (C)

Description	Product Size	Finished Graphic Size	Product Wt.	Media
31.5"	32.25"W x 82.25"H x 10.25"D	31.25"W x 79.5"H	4.6 lbs.	Titan™ Polypropylene Media
33.5"	34.25"W x 82.25"H x 10.25"D	33.25"W x 79.5"H	5 lbs.	Titan™ Polypropylene Media



Plastic swivel foot for stability.

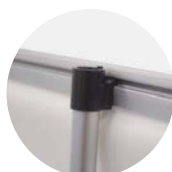

Banner rail easily attaches to the top of the pole for quick setup.



Shock cord pole makes setup and teardown easy.



Lightweight aluminum base features plastic ends.

AFTER FINAL PROOF APPROVAL PRODUCTION LEAD TIME IS
1 DAY

Prices are subject to change; visit our website for the most current pricing.
Setup fee: \$20.00(G).
See pages 208-211 for additional information that may apply to your order.

Suggested Uses

Airports
Sales Campaigns
Lobbies
Trade Shows



VALUE RETRACTOR

The Value Retractor is a cost-conscious option for your portable signage needs.

- Banner available in Titan™ polypropylene media or Titan™ no-curl hybrid media
- Two swivel feet for stability
- Available in three widths



Value Retractor

Item #	Description	1	2-5	6-11	12-24
262240	31.5" Polypropylene Media Kit	180.70	169.90	162.70	151.80
262241	31.5" No-Curl Hybrid Media Kit	240.40	226.00	216.40	202.00
262243	33.5" Polypropylene Media Kit	189.60	178.20	170.60	159.30
262244	33.5" No-Curl Hybrid Media Kit	255.75	240.50	230.25	214.75
262246	36" Polypropylene Media Kit	192.20	180.70	173.00	161.50
262247	36" No-Curl Hybrid Media Kit	266.00	250.00	239.25	223.25

Kit Includes: Hardware, Installed Graphic and Soft Carry Case

USD MSRP (C)

Description	Product Size	Finished Graphic Size	Product Wt.
31.5"	34"W x 82"H x 15"D	31.5"W x 79.5"H	7 lbs.
33.5"	35.75"W x 82"H x 15"D	33.5"W x 79.5"H	7.25 lbs.
36"	38.5"W x 82"H x 15"D	36"W x 79.5"H	7.6 lbs.



Shock cord pole makes setup and teardown easy.

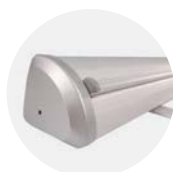

Lightweight aluminum base with plastic ends.



Prices are subject to change; visit our website for the most current pricing.
Setup fee: \$20.00(G).
See pages 208-211 for additional information that may apply to your order.

AFTER FINAL PROOF APPROVAL
PRODUCTION LEAD TIME IS
2 DAYS

ECONOMY RETRACTOR

The popular Economy Retractor is versatile and budget-friendly, making it a great option for the cost-conscious marketer.

- Lightweight aluminum base
- Banner available in Titan™ no-curl hybrid media, Titan™ no-curl opaque fabric, PVC-free silver backed media, Titan™ no-curl fabric (48" only), or dry-erase media (18" & 24" tabletop only)



Suggested Uses

- Trade Shows
- Store Promotions
- Meetings
- School Functions



Our sustainable display option uses PVC-free media and includes the recyclable aluminum base.

24"
WITH SILVER
HARDWARE
NOW AVAILABLE

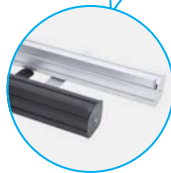

Hardware available in silver or black.



Add-Ons

Economy Retractor Hard Case

Item #	Description	1	2-5	6-11	12-24
220129	Carrying Case	85.35	80.25	76.80	71.70
				USD MSRP (C)	
Holds Economy retractors up to 36" wide					

Ultimate LED Single Light Kit

Item #	Description	1	2-5	6-11	12-24
150120	Single Light Kit	181.20	175.80	170.30	164.90
				USD MSRP (C)	



NEW
DRY-ERASE
MEDIA



24" and 18" tabletop on a 6' Standard throw shown in hot pink (sold separately; see page 14)



Printed as PMS 354C for a green screen compatible backdrop.

Tabletop Economy Retractor

Item #	Description	1	2-5	6-11	12-24
261380	18" Tabletop No-Curl Hybrid Media Kit	145.60	136.90	131.10	122.30
261381	18" Tabletop No-Curl Opaque Fabric Kit	145.60	136.90	131.10	122.30
261382	18" Tabletop PVC-Free Silver Backed Media Kit	145.60	136.90	131.10	122.30
261430	18" Tabletop Dry-Erase Media Kit	145.60	136.90	131.10	122.30
261130	24" Tabletop No-Curl Hybrid Media Kit	178.30	167.60	160.50	149.80
262160	24" Tabletop No-Curl Opaque Fabric Kit	178.30	167.60	160.50	149.80
261360	24" Tabletop PVC-Free Silver Backed Media Kit	178.30	167.60	160.50	149.80
261431	24" Tabletop Dry-Erase Media Kit	178.30	167.60	160.50	149.80

Kit Includes: Silver or Black Hardware, Installed Graphic and Soft Carry Case USD MSRP (C)

Economy Retractor

Item #	Description	1	2-5	6-11	12-24
261132	24" No-Curl Hybrid Media Kit	251.25	236.00	226.00	211.00
262161	24" No-Curl Opaque Fabric Kit	251.25	236.00	226.00	211.00
261362	24" PVC-Free Silver Backed Media Kit	251.25	236.00	226.00	211.00
261134	31.5" No-Curl Hybrid Media Kit	287.00	269.75	258.25	241.25
262162	31.5" No-Curl Opaque Fabric Kit	287.00	269.75	258.25	241.25
261364	31.5" PVC-Free Silver Backed Media Kit	287.00	269.75	258.25	241.25
261136	33.5" No-Curl Hybrid Media Kit	297.50	279.50	267.75	249.75
262163	33.5" No-Curl Opaque Fabric Kit	297.50	279.50	267.75	249.75
261366	33.5" PVC-Free Silver Backed Media Kit	297.50	279.50	267.75	249.75
261138	36" No-Curl Hybrid Media Kit	332.25	312.25	299.00	279.00
262164	36" No-Curl Opaque Fabric Kit	332.25	312.25	299.00	279.00
261368	36" PVC-Free Silver Backed Media Kit	332.25	312.25	299.00	279.00
261140	48" No-Curl Hybrid Media Kit	355.25	334.00	319.75	298.50
262165	48" No-Curl Opaque Fabric Kit	355.25	334.00	319.75	298.50
261370	48" PVC-Free Silver Backed Media Kit	355.25	334.00	319.75	298.50
262300	48" No-Curl Fabric Green Screen Kit	374.50	352.25	337.00	314.75

Kit Includes: Silver or Black Hardware, Installed Graphic and Soft Carry Case USD MSRP (C)



Description	Product Size	Finished Graphic Size	Product Wt.
18" Tabletop	19"W x 28"H x 11"D	View Product Template	5.4 lbs.
24" Tabletop	24.75"W x 39"H x 11"D	View Product Template	5.5 lbs.
24"	24.75"W x 83.5"H x 11"D	View Product Template	6 lbs.
31.5"	32"W x 83.5"H x 15"D	View Product Template	7 lbs.
33.5"	34"W x 83.5"H x 15"D	View Product Template	7.25 lbs.
36"	36.5"W x 83.5"H x 15"D	View Product Template	8.5 lbs.
48"	48"W x 83.5"H x 15"D	View Product Template	11.25 lbs.



Banner rail easily attaches to the top of the pole for quick setup.



Two swivel feet for stability (18" tabletop has one swivel foot).

HARDWARE-ONLY LEAD TIME: SHIPS SAME DAY WHEN ORDERED BEFORE 2 PM CENTRAL

Prices are subject to change; visit our website for the most current pricing.
Setup fee: \$20.00(G).
See pages 208-211 for additional information that may apply to your order.

GREEN SCREEN
AFTER FINAL PROOF APPROVAL
PRODUCTION LEAD TIME IS
24 DAYS



DUAL RETRACTOR

Get double the advertising power with this retractable banner display.

- Available in Titan™ no-curl hybrid media, Titan™ no-curl opaque fabric or PVC-free silver backed media
- Lightweight aluminum base
- Available in three widths
- Retractor features two single-sided banners
- Banners attach with snap rail on top and banner tape on bottom



Dual Retractor

Item #	Description	1	2-5	6-11	12-24
261400	31.5" No-Curl Hybrid Media Kit	350.50	343.00	314.00	306.50
261401	31.5" No-Curl Opaque Fabric Kit	350.50	343.00	314.00	306.50
261402	31.5" PVC-Free Silver Backed Media Kit	350.50	343.00	314.00	306.50
261407	33.5" No-Curl Hybrid Media Kit	365.00	357.25	327.00	319.25
261408	33.5" No-Curl Opaque Fabric Kit	365.00	357.25	327.00	319.25
261409	33.5" PVC-Free Silver Backed Media Kit	365.00	357.25	327.00	319.25
261414	36" No-Curl Hybrid Media Kit	379.50	371.25	340.00	331.75
261415	36" No-Curl Opaque Fabric Kit	379.50	371.25	340.00	331.75
261416	36" PVC-Free Silver Backed Media Kit	379.50	371.25	340.00	331.75

Kit Includes: Hardware, Installed Graphics and Soft Carry Case USD MSRP (C)

Description	Product Size	Finished Graphic Size	Product Wt.
31.5"	32.375"W x 83.375"H x 15"D	View Product Template	11.2 lbs.
33.5"	34.375"W x 83.375"H x 15"D	View Product Template	11.8 lbs.
36"	36.875"W x 83.375"H x 15"D	View Product Template	14 lbs.

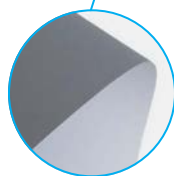

Sustainable display option uses PVC-free media and includes the recyclable aluminum base.



View artwork from the front and back of the retractor for twice the messaging power.



Shock cord pole makes setup and teardown easy.

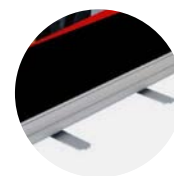

Two swivel feet for stability.

AFTER FINAL PROOF APPROVAL
PRODUCTION LEAD TIME IS
2DAYS

Prices are subject to change; visit our website for the most current pricing.
Setup fee: \$20.00(G).
See pages 208-211 for additional information that may apply to your order.



DELUXE PRO RETRACTOR

The Deluxe Pro Retractor features a curved base with durable aluminum end caps. Swapping out graphics is a breeze with the hook-and-loop banner system.

- Banner available in Titan™ no-curl opaque fabric or dry-erase media
- Banner is printed single-sided; double-sided option includes two banners



Deluxe Pro Retractor

Item #	Description	1	2-5	6-11	12-24
262250	33.5" Single No-Curl Opaque Fabric Kit	354.75	333.50	319.25	298.00
262251	33.5" Double No-Curl Opaque Fabric Kit	536.00	522.50	480.50	467.00
262202	33.5" Single Dry-Erase Media Kit	354.75	333.50	319.25	298.00
262203	33.5" Double Dry-Erase Media Kit	536.00	522.50	480.50	467.00
262254	46.5" Single No-Curl Opaque Fabric Kit	475.50	447.00	427.75	399.25
262255	46.5" Double No-Curl Opaque Fabric Kit	702.00	683.00	629.00	610.00
262204	46.5" Single Dry-Erase Media Kit	475.50	447.00	427.75	399.25
262205	46.5" Double Dry-Erase Media Kit	702.00	683.00	629.00	610.00
Kit Includes: Hardware, Installed Graphic(s) and Soft Carry Case				USD MSRP (C)	

Description	Product Size (Single / Double)	Finished Graphic Size	Product Wt. (Single / Double)
33.5"	34.75"W x 65.25"-83.25"H x 8.5"D / 9.25"D	33.5"W x 61.5"-79.5"H	12.25 lbs. / 16 lbs.
46.5"	48.5"W x 65.25"-83.25"H x 8.5"D / 9.25"D	46.5"W x 61.5"-79.5"H	16.75 lbs. / 22.5 lbs.



Flip-lever telescoping pole makes setup and adjustment simple.



Hook-and-loop fasteners make banners easy to swap out.



Streamlined base is available in single- and double-banner options.

Dry-Erase Media

Dry-erase media is both fun and functional. It features a glossy surface that has the write-on/ wipe-off utility of a dry-erase board (dry-erase markers not included).



Prices are subject to change; visit our website for the most current pricing.
Setup fee: \$20.00(G).
See pages 208-211 for additional information that may apply to your order.

FABRIC DRY-ERASE
AFTER FINAL PROOF APPROVAL
PRODUCTION LEAD TIME IS
1 or 2 DAYS

- Restaurants
- Trade Shows
- Entryways
- Clinics

STRATUS RETRACTOR

The Stratus Retractor's streamlined base features a low center of gravity to keep it stable, eliminating the need for fold-out feet.

- Durable, lightweight construction
- Banner available in Titan™ no-curl hybrid media, Titan™ no-curl opaque fabric, dry-erase media or PVC-free silver backed media

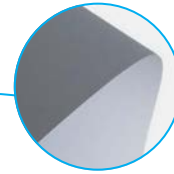

Our sustainable display option uses PVC-free media and includes the recyclable aluminum base.



Aluminum base features chrome end caps and has a low center of gravity.



PVC-free silver backed media is free of heavy metals and phthalates. See website for more information.



Stratus Retractor

Item #	Description	1	2-5	6-11	12-24
262070	24" No-Curl Hybrid Media Kit	304.25	286.00	274.00	255.50
262150	24" No-Curl Opaque Fabric Kit	304.25	286.00	274.00	255.50
261460	24" PVC-Free Silver Backed Media	304.25	286.00	274.00	255.50
262206	24" Dry-Erase Media Kit	304.25	286.00	274.00	255.50
262072	31.5" No-Curl Hybrid Media Kit	348.00	327.25	313.25	292.50
262151	31.5" No-Curl Opaque Fabric Kit	348.00	327.25	313.25	292.50
261461	31.5" PVC-Free Silver Backed Media	348.00	327.25	313.25	292.50
262207	31.5" Dry-Erase Media Kit	348.00	327.25	313.25	292.50
262074	33.5" No-Curl Hybrid Media Kit	361.50	339.75	325.25	303.50
262152	33.5" No-Curl Opaque Fabric Kit	361.50	339.75	325.25	303.50
261462	33.5" PVC-Free Silver Backed Media	361.50	339.75	325.25	303.50
262208	33.5" Dry-Erase Media Kit	361.50	339.75	325.25	303.50
262076	36" No-Curl Hybrid Media Kit	384.50	361.50	346.00	323.00
262153	36" No-Curl Opaque Fabric Kit	384.50	361.50	346.00	323.00
261463	36" PVC-Free Silver Backed Media	384.50	361.50	346.00	323.00
262209	36" Dry-Erase Media Kit	384.50	361.50	346.00	323.00
262078	48" No-Curl Hybrid Media Kit	426.00	400.50	383.50	357.75
262154	48" No-Curl Opaque Fabric Kit	426.00	400.50	383.50	357.75
261464	48" PVC-Free Silver Backed Media	426.00	400.50	383.50	357.75
262210	48" Dry-Erase Media Kit	426.00	400.50	383.50	357.75

Kit Includes: Hardware, Installed Graphic and Soft Carry Case USD MSRP (C)

Description	Product Size	Finished Graphic Size	Product Wt.
24"	25.25"W x 67.5"H-81.625"H x 7.125"D	View Product Template	8.75 lbs.
31.5"	33"W x 67.5"H-81.625"H x 7.125"D	View Product Template	11.25 lbs.
33.5"	34.25"W x 67.5"H-81.625"H x 7.125"D	View Product Template	12 lbs.
36"	37.25"W x 67.5"H-81.625"H x 7.125"D	View Product Template	12.5 lbs.
48"	49.5"W x 67.5"H-81.625"H x 7.125"D	View Product Template	17.25 lbs.



Banner rail easily attaches to the top of the pole for quick setup.



Hook-and-loop fasteners make banners easy to swap out.



Shock cord pole with telescoping flip-lever extension makes setup and adjustment simple.

Dry-Erase Media

Dry-erase media is both fun and functional. It features a glossy surface that has the write-on/wipe-off utility of a dry-erase board (dry-erase markers not included).



Prices are subject to change; visit our website for the most current pricing. Setup fee: \$20.00(G). See pages 208-211 for additional information that may apply to your order.

AFTER FINAL PROOF APPROVAL
PRODUCTION LEAD TIME IS
2 DAYS



33.5"

31.5"



Dry-Erase Media

Dry-erase media is both fun and functional. It features a glossy surface that has the write-on/wipe-off utility of a dry-erase board (dry-erase markers not included).



Banner rail easily attaches to the top of the pole for quick setup.

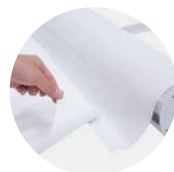

Hook-and-loop fasteners make banners easy to swap out.

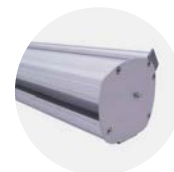

Heavy-duty aluminum base available in silver.



ECONOMY PLUS RETRACTOR

This display elevates our popular Economy Retractor with improved durability and additional features.

- Available in two widths
- Single-footed design keeps the retractor stable while maintaining a low profile
- Flip-lever telescoping pole makes setup and adjustment simple
- Banner available in Titan™ no-curl hybrid media, Titan™ no-curl opaque fabric or dry-erase media



Economy Plus Retractor

Item #	Description	1	2-5	6-11	12-24
261012	31.5" No-Curl Hybrid Media Kit	325.75	306.00	293.00	273.50
262180	31.5" No-Curl Opaque Fabric Kit	325.75	306.00	293.00	273.50
262191	31.5" Dry-Erase Media Kit	325.75	306.00	293.00	273.50
261002	33.5" No-Curl Hybrid Media Kit	343.00	322.50	308.50	288.00
262181	33.5" No-Curl Opaque Fabric Kit	343.00	322.50	308.50	288.00
262192	33.5" Dry-Erase Media Kit	343.00	322.50	308.50	288.00

Kit Includes: Hardware, Installed Graphic and Soft Carry Case USD MSRP (C)

Description	Product Size	Finished Graphic Size	Product Wt.
31.5"	32"W x 64"-82.5"H x 15"D	31.5"W x 60"-78.5"H	7 lbs.
33.5"	34"W x 64"-82.5"H x 15"D	33.5"W x 60"-78.5"H	7.5 lbs.

AFTER FINAL PROOF APPROVAL
PRODUCTION LEAD TIME IS
2DAYS

Prices are subject to change; visit our website for the most current pricing.
Setup fee: \$20.00(G).
See pages 208-211 for additional information that may apply to your order.



INSTACHANGE RETRACTOR

Spruce up your environment with this modern retractor that allows for easily changing your message on the fly.

- Available in two widths
- Artwork is printed on Titan™ no-curl opaque fabric
- Flip-lever telescoping pole makes setup and adjustment simple
- Easy-to-install replaceable graphic cartridge
- Hardware available in high-gloss black or white base



InstaChange Retractor

Item #	Description	1	2-5	6-11	12-24
261340	33.5" Kit	566.50	532.50	510.00	476.00
261342	33.5" Cartridge Kit	188.90	177.50	170.00	158.70
261343	40" Kit	661.00	621.50	594.50	555.00
261345	40" Cartridge Kit	220.40	207.20	198.40	185.10

Kit Includes: Black or White Hardware, Installed Graphic and Soft Carry Case USD MSRP (C)
Cartridge Kit Includes: Cartridge with Installed Graphic and Snap Rail

Description	Product Size	Finished Graphic Size	Product Wt.	Media
33.5"	35.125"W x 63.875"- 88.25"H x 8.625"D	33.5"W x 59.625"-84"H	14 lbs.	No-Curl Opaque Fabric
40"	41.125"W x 63.875"- 88.25"H x 8.625"D	39.25"W x 59.625"-84"H	15.85 lbs.	No-Curl Opaque Fabric



Shock cord pole with telescoping flip-lever extension makes setup and adjustment simple.



Sleek-looking cartridge is inserted into the base for convenient graphic changes.



Base unlocks with a simple twist to release the cartridge.



Simply lift to remove cartridge for easy graphic replacement.

Prices are subject to change; visit our website for the most current pricing.
Setup fee: \$20.00(G).
See pages 208-211 for additional information that may apply to your order.

AFTER FINAL PROOF APPROVAL
PRODUCTION LEAD TIME IS
2DAYS



LIGHTS UP!



SPOTLIGHT RETRACTOR

Illuminate the possibilities at your next event with this lit retractor.

- Has the look of a light box with the portability, convenience and easy setup of a retractable banner
- Artwork is printed on flexible backlit film
- Light is radiated from the base by LED lights
- Kit includes two single-sided banners
- Plugs into any standard USA outlet
- Illuminate up to three units via a single power source with the included connector cords
- On/off switch for the lights is located on the side of the base
- UL/CE certified
- US Patent #201920486314.5



Spotlight Retractor

Item #	Description	1	2-5	6-11	12-24
261304	Kit	706.50	664.50	635.50	593.50
Kit Includes: Hardware, 2 Installed Graphics and Soft Carry Case				USD MSRP (C)	

Product Size	Finished Graphic Size	Product Wt.	Media
34"W x 84"H x 10.25"D	31.25"W x 78.5"H	22 lbs.	Flexible Backlit Film



Connector cord can be used to link retractors together.



LED lights integrated into the base provide illumination.



Hardware holds two banners for a double-sided display.



Shock cord pole makes setup and teardown easy.

AFTER FINAL PROOF APPROVAL
PRODUCTION LEAD TIME IS
2DAYS

Prices are subject to change; visit our website for the most current pricing.
Setup fee: \$20.00(G).
See pages 208-211 for additional information that may apply to your order.

Suggested Uses

Colleges
Restaurants
Lobbies
Airports

SUPERB RETRACTOR

This retractor features a flip-open base for easy graphic changes, and its hardware is built to last a lifetime.

- Durable construction makes this a long-lasting option
- Artwork is printed on Titan™ no-curl hybrid media



Superb Retractor

Item #	Description	1	2-5	6-11	12-24
261118	Kit	471.25	443.00	424.25	396.00
262023	Banner and Roller	300.75	282.75	270.50	252.50
Kit Includes: Hardware, Installed Graphic and Soft Carry Case		USD MSRP (C)			

Product Size	Finished Graphic Size	Product Wt.	Media
35.5"W x 37"-80.5"H x 7.75"D	33.5"W x 31.5"-78"H	8 lbs.	Titan™ No-Curl Hybrid Media



RETRACTABLE BANNERS



Flip-lever telescoping pole makes setup and adjustment simple.



Flip-open base allows for easy banner changes.



Low-profile base is available with black or silver ends.

MAGNALINK RETRACTOR

This retractor features magnetic end caps so you can link several banners and create an extra-wide display.

- Artwork is dye sublimated on Titan™ no-curl fabric
- Footless base creates a discreet appearance
- When connected, there will be a 1" gap between banners
- Available in three widths



MagnaLink Retractor

Item #	Description	1	2-5	6-11	12-24
261205	16" Kit	333.50	313.50	300.00	280.00
261210	33.5" Kit	459.00	431.50	413.00	385.50
261215	60" Kit	690.00	648.50	621.00	579.50
Kit Includes: Hardware, Installed Graphic and Soft Carry Case		USD MSRP (C)			

Description	Product Size	Finished Graphic Size	Product Wt.	Media
16"	17.25"W x 84"-91.75"H x 8.5"D	15.75"W x 82.25"-90"H	7.25 lbs.	Titan™ No-Curl Fabric
33.5"	34.75"W x 31.75"-91.75"H x 8.5"D	33.375"W x 29.875"-90"H	13 lbs.	Titan™ No-Curl Fabric
60"	61.25"W x 31.75"-91.75"H x 8.5"D	59"W x 29.875"-90"H	21.75 lbs.	Titan™ No-Curl Fabric

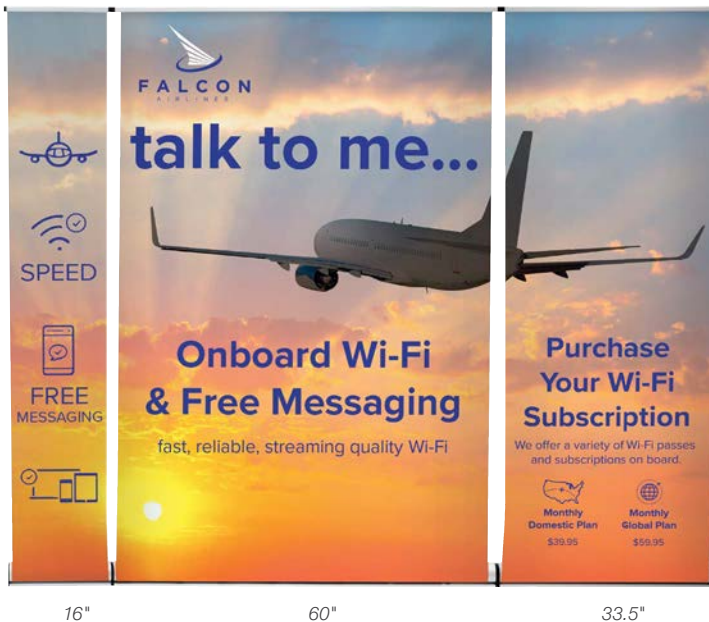

16"

60"

33.5"



Magnetic end caps on base and top rail keep multiple units aligned for a professional appearance.



Flip-lever telescoping pole makes setup and adjustment simple.



Hook-and-loop fasteners make banners easy to swap out.

Prices are subject to change; visit our website for the most current pricing.
Setup fee: \$20.00(G).
See pages 208-211 for additional information that may apply to your order.

SUPERB MAGNALINK
AFTER FINAL PROOF APPROVAL
PRODUCTION LEAD TIME IS
1-OR-14 DAYS



Suggested Uses

- Sidewalk Sales
- Outdoor Events
- Terraces
- Bar Promotions

ELEMENT RETRACTOR

Hidden between this retractor's banners is a sturdy ballast that utilizes water or sand to keep the display stable for outdoor use.

- Artwork is printed on Titan™ 13 oz. scrim vinyl
- Kit includes two single-sided banners
- Ballast holds up to 2.6 gallons of water
- Banners used outdoors have a 90-day warranty; banners used indoors have a 1-year warranty



Element Retractor

Item #	Description	1	2-5	6-11	12-24
261270	Kit	600.00	564.00	540.00	504.00
Kit Includes: Hardware, 2 Installed Graphics, 4 Stakes and Soft Carry Case				USD MSRP (C)	

Product Size	Finished Graphic Size	Product Wt.	Media
34.5"W x 38.75"-81.5"H x 20.5"D	33.25"W x 37"-80.25"H	22.5 lbs.	Titan™ 13 oz. Scrim Vinyl



Removable ballast can be filled with water or sand to keep display stable outdoors.



Feet pull out for added stability in outdoor conditions.



Includes four stakes to secure feet to the ground.



Three-section flip lever telescoping pole makes setup and adjustment simple.



Includes four stakes to secure feet to the ground.

OUTDOOR TREK LITE RETRACTOR

This retractor's large removable feet keep it stable in the wind, making it perfect for temporary outdoor use.

- Shock cord pole for easy assembly
- Artwork is printed on Titan™ 13 oz. scrim vinyl
- Kit includes two single-sided banners
- Banners used outdoors have a 90-day warranty; banners used indoors have a 1-year warranty



Outdoor Trek Lite Retractor

Item #	Description	1	2-5	6-11	12-24
263040	Kit	544.50	529.00	488.50	473.00
Kit Includes: Hardware, 2 Installed Graphics, 4 Stakes and Soft Carry Case				USD MSRP (C)	

Product Size	Finished Graphic Size	Product Wt.	Media
35.75"W x 82.25"H x 32.25"D	33.25"W x 77.25"H	22.75 lbs.	Titan™ 13 oz. Scrim Vinyl

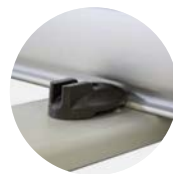

Removable feet attach securely to the base for a stable footprint.



Heavy-duty base with black ends.

AFTER FINAL PROOF APPROVAL
PRODUCTION LEAD TIME IS
2DAYS

Prices are subject to change; visit our website for the most current pricing.
Setup fee: \$20.00(G).

See pages 208-211 for additional information that may apply to your order.



ECO-LITE RETRACTOR

Our most sustainable retractor is 100% recyclable and is perfect for limited use.

- Artwork is printed on paper-based media
- Base, pole and top bar are made of corrugated cardboard
- Quick assembly with spring-loaded pole
- Manually create tension and retract graphic with plastic knobs



Eco-Lite Retractor

Patent Pending

Item #	Description	1	2-5	6-11	12-24
261308	Kit	200.00	190.00	184.00	174.00
Kit Includes: Hardware and Installed Graphic					USD MSRP (C)

Product Size	Finished Graphic Size	Product Wt.	Media
40.25"W x 85.625"H x 9.875"D	31"W x 88"H	5 lbs.	Paper-Based Media



Banner top bar securely attaches to the top of the pole for quick setup.



Corrugated cardboard pole is spring-loaded and helps keep graphic taut while on display.



Plastic knobs on the sides of the base allow for manual tension and to easily retract graphic into the base.

Prices are subject to change; visit our website for the most current pricing.
Setup fee: \$20.00(G).
See pages 208-211 for additional information that may apply to your order.

AFTER FINAL PROOF APPROVAL
PRODUCTION LEAD TIME IS
2 DAYS

Suggested Uses

- Trade Shows
- Press Conferences
- Meetings
- Sports Arenas



8'

6'

5'



Printed as PMS 354C for a green screen compatible backdrop.

JUMBO WIDE RETRACTOR

Create an impressive backdrop with this ultra-wide retractable banner.

- High-tension base springs keep the banner taut
- Double-footed design for stability
- Banner available in Titan™ no-curl fabric or Titan™ 13 oz. smooth scrim vinyl
- Available in three widths

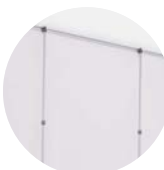

Two shock cord poles support the banner.

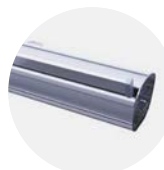

Hardware comes in silver.

Jumbo Wide Retractor

Item #	Description	1	2-5	6-11	12-24
262138	5' No-Curl Fabric Kit	705.50	663.00	635.00	592.50
261080	5' 13 oz. Smooth Scrim Vinyl Kit	705.50	663.00	635.00	592.50
262304	5' No-Curl Fabric Green Screen Kit	705.50	663.00	635.00	592.50
262139	6' No-Curl Fabric Kit	852.50	801.50	767.50	716.00
261082	6' 13 oz. Smooth Scrim Vinyl Kit	852.50	801.50	767.50	716.00
262308	6' No-Curl Fabric Green Screen Kit	852.50	801.50	767.50	716.00
262140	8' No-Curl Fabric Kit	996.50	936.50	897.00	837.00
261018	8' 13 oz. Smooth Scrim Vinyl Kit	996.50	936.50	897.00	837.00
262312	8' No-Curl Fabric Green Screen Kit	996.50	936.50	897.00	837.00

Kit Includes: Hardware, Installed Graphic and Soft Carry Case USD MSRP (C)

Description	Product Size	Finished Graphic Size	Product Wt. (Fabric / Vinyl)
5'	60.5"W x 83"H x 15.75"D	59.75"W x 78.75"H	18.85 lbs. / 20.75 lbs.
6'	72.5"W x 83"H x 15.75"D	71.75"W x 78.75"H	21.35 lbs. / 23.5 lbs.
8'	95.5"W x 83"H x 15.75"D	94.75"W x 78.75"H	26.35 lbs. / 29.5 lbs.

VINYL | FABRIC
AFTER FINAL PROOF APPROVAL
PRODUCTION LEAD TIME IS
24 DAYS

Prices are subject to change; visit our website for the most current pricing.
Setup fee: \$20.00(G).
See pages 208-211 for additional information that may apply to your order.

NEW
DRY-ERASE
MEDIA



24" Economy

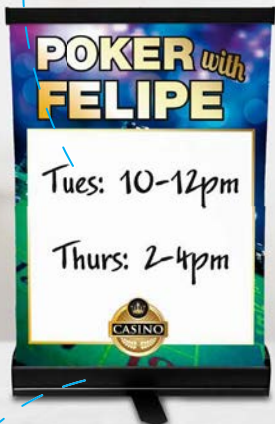

18" Economy



Deluxe Mini



Small Mini Promo



Large Mini Promo

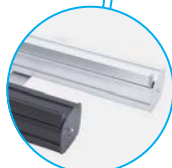

18" and 24" hardware available in silver or black.



Flip-open base discretely hides the pole and banner when not in use.



Lightweight aluminum base has a small footprint.

MINI RETRACTORS

These mini retractors can be used even when space is limited.

- Compact size
- Lightweight and portable
- Warranties range between six months to one year (see Retractable Banner Comparison Chart on page 29 for details)



Economy Tabletop Retractor

Item #	Description	1	2-5	6-11	12-24
261380	18" Tabletop No-Curl Hybrid Media Kit	145.60	136.90	131.10	122.30
261381	18" Tabletop No-Curl Opaque Fabric Kit	145.60	136.90	131.10	122.30
261382	18" Tabletop PVC-Free Silver Backed Media Kit	145.60	136.90	131.10	122.30
261430	18" Dry-Erase Media Kit	145.60	136.90	131.10	122.30
261130	24" Tabletop No-Curl Hybrid Media Kit	178.30	167.60	160.50	149.80
262160	24" Tabletop No-Curl Opaque Fabric Kit	178.30	167.60	160.50	149.80
261360	24" Tabletop PVC-Free Silver Backed Media Kit	178.30	167.60	160.50	149.80
261431	24" Dry-Erase Media Kit	178.30	167.60	160.50	149.80

Kit Includes: Silver or Black Hardware, Installed Graphic and Soft Carry Case USD MSRP (C)

Description	Product Size	Finished Graphic Size	Product Wt.	Media
18" Economy	19"W x 28"H x 11"D	View Product Template	5.4 lbs.	See Kit Description
24" Economy	24.75"W x 39"H x 11"D	View Product Template	5.5 lbs.	See Kit Description

Deluxe Mini Retractor

Item #	Description	1	2-5	6-11	12-24
262014	Kit	75.55	72.55	70.25	66.50

Kit Includes: Hardware and Installed Graphic USD MSRP (C)

Mini Promo Retractor

Item #	Description	1	2-5	6-11	12-24
210240	Small Kit	58.50	56.15	54.40	51.50
210242	Large Kit	65.40	62.80	60.80	57.55

Kit Includes: Hardware and Installed Graphic USD MSRP (C)

Description	Product Size	Finished Graphic Size	Product Wt.	Media
Deluxe Mini	9.375"W x 17.75"H x 4"D	8.25"W x 16.25"H	1.5 lbs.	Titan™ Polypropylene Media
Small Mini Promo	9.625"W x 13.25"H x 3"D	8.25"W x 12"H	1 lb.	Titan™ Polypropylene Media
Large Mini Promo	13.125"W x 17.875"H x 3"D	11.5"W x 16.5"H	1 lb.	Titan™ Polypropylene Media

Prices are subject to change; visit our website for the most current pricing.
Setup fee: \$20.00(G).
See pages 208-211 for additional information that may apply to your order.

AFTER FINAL PROOF APPROVAL
PRODUCTION LEAD TIME IS
2DAYS

BANNER DISPLAYS

When choosing a banner display
have you considered...

- **LOCATION** - Where will your product be displayed?
- **MESSAGE** - Do you want a single- or double-sided display?
- **TRANSPORT** - Will your display be stationary or will it be moved from place to place?
- **LONGEVITY** - How long will your message be displayed?



Suggested Uses

Lobbies
Entryways
Trade Shows
Restaurants

FRAMEWORX BANNER DISPLAY

These lightweight displays feature a contemporary design that brings new life to your exhibit.

- Banners attach using low-profile clear grommets
- 3' and 3.5' frames available in black or silver
- 4.5', 8.5' and 10.5' frames available in black only



Tension springs keep the banner centered and taut.

Fold-out feet for a small, but stable footprint.

Each tension spring features a double-sided hook so you can hang one banner or two.

3' FrameWorx Banner Display

Item #	Description	1	2-5	6-11	12-24
263061	13 oz. Smooth Scrim Vinyl Single-Sided Kit	179.20	172.00	166.70	157.70
263062	13 oz. Smooth Scrim Vinyl Double-Sided Kit	214.40	205.80	199.40	188.70
263065	No-Curl Opaque Fabric Kit	228.40	219.20	212.40	201.00

Kit Includes: Silver or Black Hardware, Graphic and Soft Carry Case USD MSRP (C)

Product Size 36.75"W x 74"H x 15.5"D
Finished Graphic Size View Online Template
Product Wt. 5.6 lbs.

3.5' FrameWorx Banner Display

Item #	Description	1	2-5	6-11	12-24
263070	13 oz. Smooth Scrim Vinyl Single-Sided Kit	200.30	192.30	186.30	176.30
263071	13 oz. Smooth Scrim Vinyl Double-Sided Kit	235.40	226.00	218.90	207.20
263074	No-Curl Opaque Fabric Kit	243.80	234.10	226.70	214.60

Kit Includes: Silver or Black Hardware, Graphic and Soft Carry Case USD MSRP (C)

Product Size 41"W x 81.75"H x 15.5"D
Finished Graphic Size View Online Template
Product Wt. 6.2 lbs.

4.5' FrameWorx Banner Display

Item #	Description	1	2-5	6-11	12-24
263314	13 oz. Smooth Scrim Vinyl Single-Sided Kit	244.40	234.70	227.30	215.10
263315	13 oz. Smooth Scrim Vinyl Double-Sided Kit	279.50	268.50	260.00	246.00
263317	No-Curl Opaque Fabric Kit	286.75	275.25	266.50	252.25

Kit Includes: Black Hardware, Graphic and Soft Carry Case USD MSRP (C)

Product Size 54.75"W x 90.25"H x 15.5"D
Finished Graphic Size View Online Template
Product Wt. 10.5 lbs.

8.5' FrameWorx Banner Display

Item #	Description	1	2-5	6-11	12-24
263328	600 Denier Polyester Kit	471.75	453.00	438.75	415.25

Kit Includes: Black Hardware, Graphic and Soft Carry Case USD MSRP (C)

Product Size 101.75"W x 90.5"H x 15.5"D
Finished Graphic Size View Online Template
Product Wt. 15 lbs.

10.5' FrameWorx Banner Display

Item #	Description	1	2-5	6-11	12-24
263331	600 Denier Polyester Kit	516.00	495.50	480.00	454.00

Kit Includes: Black Hardware, Graphic and Soft Carry Case USD MSRP (C)

Product Size 123.25"W x 90.25"H x 15.5"D
Finished Graphic Size View Online Template
Product Wt. 17 lbs.

Prices are subject to change; visit our website for the most current pricing.
Setup fee: \$20.00(G).
See pages 208-211 for additional information that may apply to your order.

VINYL & NO-CURL
600 DENIER
AFTER FINAL PROOF APPROVAL
PRODUCTION LEAD TIME IS
24 DAYS

Suggested Uses

- Sporting Events
- Fundraisers
- Restaurants
- Parties



Tension springs keep the banner centered and taut.

8.5' Quad

4.5' Double

3.5' Single

3.5' Double

3.5' Junior

Fold-out feet for a small, but stable footprint.

FRAMEWORX FACE CUTOUT

Let your guests become part of the show with this creative spin on our traditional FrameWorX display.

- Banners attach using low-profile clear grommets
- 3.5' frames available in black or silver
- 4.5' and 8.5' frames available in black only
- Face cutout hole locations are standard and cannot be customized



3.5' FrameWorX Face Cutout

Item #	Description	1	2-5	6-11	12-24
263054	13 oz. Smooth Scrim Vinyl Single Face Cutout Kit	200.30	192.30	186.30	176.30
263055	13 oz. Smooth Scrim Vinyl Double Face Cutout Kit	200.30	192.30	186.30	176.30
263056	13 oz. Smooth Scrim Vinyl Junior Face Cutout Kit	200.30	192.30	186.30	176.30

Kit Includes: Silver or Black Hardware, Graphic and Soft Carry Case USD MSRP (C)

Product Size	Finished Graphic Size	Product Wt.
41"W x 81.75"H x 15.5"D	View Online Template	6.2 lbs.

4.5' FrameWorX Face Cutout

Item #	Description	1	2-5	6-11	12-24
263057	13 oz. Smooth Scrim Vinyl Double Face Cutout Kit	244.40	234.70	227.30	215.10

Kit Includes: Black Hardware, Graphic and Soft Carry Case USD MSRP (C)

Product Size	Finished Graphic Size	Product Wt.
54.75"W x 90.25"H x 15.5"D	View Online Template	10.5 lbs.

8.5' FrameWorX Face Cutout

Item #	Description	1	2-5	6-11	12-24
263334	600 Denier Polyester Quad Face Cutout Kit	490.75	471.25	456.50	432.00

Kit Includes: Black Hardware, Graphic and Soft Carry Case USD MSRP (C)

Product Size	Finished Graphic Size	Product Wt.
101.75"W x 90.5"H x 15.5"D	View Online Template	15 lbs.



Face cutouts in 600 denier polyester are reinforced with black Lycra® binding, giving each cutout a black outline.



Face cutouts in vinyl do not have an outline.

VINYL 600 DENIER
AFTER FINAL PROOF APPROVAL
PRODUCTION LEAD TIME IS
24 DAYS

Prices are subject to change; visit our website for the most current pricing.
Setup fee: \$20.00(G).
See pages 208-211 for additional information that may apply to your order.

ESSENTIAL BANNER DISPLAY

Stick to the essentials. This banner display combines classic form and function to make your message stand out.

- Lightweight and simple
- Tripod-style legs and telescoping pole for fast and easy setup
- Banners attach quickly using snap rails
- Artwork is printed on Titan™ no-curl fabric
- Includes two single-sided banners for a double-sided display
- Telescoping pole is compatible with custom banner heights (call for quote; restrictions may apply)



Essential Banner Display

Item #	Description	1	2-5	6-11	12-24
263410	Kit	225.00	216.00	209.30	198.00
Kit Includes: Hardware, 2 Single-Sided Graphics and Soft Carry Case		USD MSRP (C)			

Product Size	Finished Graphic Size	Product Wt.	Media
28.625"W x 65"-89"H x 28.625"D	23.625"W x 54"H	6 lbs.	Titan™ No-Curl Fabric

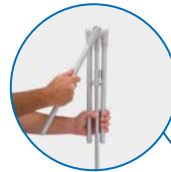

Hardware folds together in one piece for easy transportation.

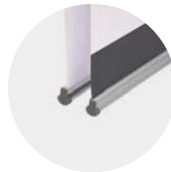

Simply slide the banner into the snap rails and clamp shut.

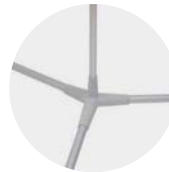

Tripod-style legs provide stability.



Flip-lever telescoping pole makes setup and adjustment simple.

XPRESS BANNER DISPLAY

This banner display features an umbrella-like mechanism that makes setup and take down a breeze.

- Artwork is dye sublimated on two-way stretch fabric
- Graphic remains on hardware for easy setup
- Compact for transport and storage
- Warranty details available online



Xpress Banner Display

Item #	Description	1	2-5	6-11	12-24
264365	36"W x 54"H Kit	157.40	151.10	146.30	138.50
264366	54"W x 36"H Kit	157.40	151.10	146.30	138.50
Kit Includes: Hardware, Graphic and Drawstring Pouch		USD MSRP (C)			

Description	Product Size	Finished Graphic Size	Product Wt.	Media
36"W x 54"H	36.5"W x 54"H x 20.25"D	View Online Template	2 lbs.	Two-Way Stretch Fabric
54"W x 36"H	54"W x 36.5"H x 25.75"D	View Online Template	2 lbs.	Two-Way Stretch Fabric

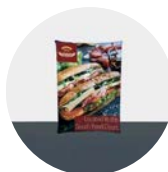

Tabletop Xpress Banner Display is also available. See page 159.



Umbrella-like pole hardware lets the display expand and contract with the push of a button.



X-shaped hardware design gives the display its structure.

Prices are subject to change; visit our website for the most current pricing.
Setup fee: \$20.00(G).
See pages 208-211 for additional information that may apply to your order.

ESSENTIAL | XPRESS
AFTER FINAL PROOF APPROVAL
PRODUCTION LEAD TIME IS
3 OR 4 DAYS

X BANNER DISPLAYS

The clean X design of these displays makes them simple, durable and easy to assemble.

- Artwork is printed on Titan™ 13 oz. smooth scrim vinyl
- The X shape of the frame is designed to keep the banner taut
- Corner grommets attach to plastic hooks on display arms
- Banners are finished with brass grommets by default; can be customized with nickel or clear plastic grommets by request
- Warranty details available online



Lightweight plastic hub offers push-button arm adjustment.

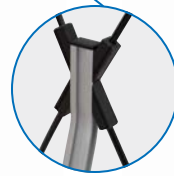

Aluminum hub extends into the strong support leg.



Back leg attaches to the aluminum hub to stabilize the display.

Euro-X Banner Display

Item #	Description	1	2-5	6-11	12-24
263123	23.5" x 70" Kit	201.40	193.30	187.30	177.20
263120	31.5" x 70" Kit	251.75	241.75	234.25	221.50
263126	31.5" x 79" Kit	264.25	253.75	245.75	232.50

Kit Includes: Hardware, Graphic and Drawstring Case

USD MSRP (C)

Description	Product Size	Finished Graphic Size	Product Wt.	Media
23.5" x 70"	23.5"W x 70"H x 23"D	23.5"W x 70"H	2.75 lbs.	Titan™ 13 oz. Smooth Scrim Vinyl
31.5" x 70"	31.5"W x 70"H x 20.5"D	31.5"W x 70"H	3.25 lbs.	Titan™ 13 oz. Smooth Scrim Vinyl
31.5" x 79"	31.5"W x 79"H x 20.5"D	31.5"W x 79"H	3.5 lbs.	Titan™ 13 oz. Smooth Scrim Vinyl

Taurus Banner Display

Item #	Description	1	2-5	6-11	12-24
210124	Kit	229.00	219.80	213.00	201.50

Kit Includes: Hardware, Graphic and Soft Carry Case

USD MSRP (C)

Product Size	Finished Graphic Size	Product Wt.	Media
40"W x 75"H x 14"D	40"W x 75"H	5.25 lbs.	Titan™ 13 oz. Smooth Scrim Vinyl

Tri-X Banner Display

Item #	Description	1	2-5	6-11	12-24
263109	23.5" x 60" Kit	117.00	112.30	108.80	103.00
263106	23.5" x 70" Kit	129.60	124.40	120.50	114.00
263103	31.5" x 70" Kit	159.90	153.50	148.70	140.70
263112	31.5" x 79" Kit	183.70	176.40	170.80	161.70
263100	33.5" x 80" Kit	187.50	180.00	174.40	165.00

Kit Includes: Hardware, Graphic and Drawstring Case

USD MSRP (C)

Description	Product Size	Finished Graphic Size	Product Wt.	Media
23.5" x 60"	23.5"W x 60"H x 32.5"D	23.5"W x 60"H	2 lbs.	Titan™ 13 oz. Smooth Scrim Vinyl
23.5" x 70"	23.5"W x 70"H x 33.5"D	23.5"W x 70"H	2.25 lbs.	Titan™ 13 oz. Smooth Scrim Vinyl
31.5" x 70"	31.5"W x 70"H x 31.5"D	31.5"W x 70"H	2.25 lbs.	Titan™ 13 oz. Smooth Scrim Vinyl
31.5" x 79"	31.5"W x 79"H x 32.5"D	31.5"W x 79"H	3 lbs.	Titan™ 13 oz. Smooth Scrim Vinyl
33.5" x 80"	33.5"W x 80"H x 32.5"D	33.5"W x 79"H	3.25 lbs.	Titan™ 13 oz. Smooth Scrim Vinyl



Mini X Banner Display is perfect for small areas. See page 159.

AFTER FINAL PROOF APPROVAL
PRODUCTION LEAD TIME IS
2DAYS

Prices are subject to change; visit our website for the most current pricing.
Setup fee: \$20.00(G).

See pages 208-211 for additional information that may apply to your order.



EVERYDAY BANNER DISPLAY

These displays feature a durable steel frame with a long-lasting, powder-coated finish.

- The Everyday Banner Display features pole pockets and dowels to hold the banner in place
- The Everyday Heavy-Duty Banner Display has all the same features as the Everyday Banner Display, but reinforced with a stronger, thicker frame and wider base
- The Everyday Snap Rail Banner Display replaces the dowel and pole pockets with snap rails for a clean finish
- Graphics are printed single-sided; double-sided kit includes two graphics
- Hex wrench included



Everyday Banner Display

Item #	Description	1	2-5	6-11	12-24
210265	Everyday Single-Sided Kit	232.90	223.60	216.60	205.00
264020	Everyday Double-Sided Kit	319.50	306.75	297.25	281.25
210226	Everyday Heavy-Duty Single-Sided Kit	275.50	264.50	256.25	242.50
264021	Everyday Heavy-Duty Double-Sided Kit	362.50	348.00	337.25	319.00
190161	72"H x 24"W Banner Only*	94.40	90.60	87.80	83.05

Single-Sided Kit Includes: Hardware, 1 Graphic and (2) 24" Dowels USD MSRP (C)
 Double-Sided Kit Includes: Hardware, 2 Graphics and (4) 24" Dowels
 *Dowels not included in banner only orders

Description	Product Size	Finished Graphic Size	Product Wt. (Single / Double)	Media
Everyday	24"W x 48"-92"H x 13"D	12"-36"W x 12"-91"H	11 lbs. / 12.25 lbs.	Titan™ 11 mil Polyester
Heavy-Duty	24"W x 55"-105"H x 14"D	12"-36"W x 12"-104"H	13.5 lbs. / 14.5 lbs.	Titan™ 11 mil Polyester

Everyday Snap Rail Banner Display

Item #	Description	1	2-5	6-11	12-24
264030	24" Single-Sided Kit	258.00	247.75	240.00	227.00
264022	24" Double-Sided Kit	344.75	331.00	320.50	303.50
264032	30" Single-Sided Kit	270.75	260.00	251.75	238.25
264023	30" Double-Sided Kit	368.00	353.25	342.25	323.75
190310	24" Banner Only	94.40	90.60	87.80	83.05
190311	30" Banner Only	105.80	101.60	98.40	93.10

24" Kit Includes: Hardware and Single-Sided Graphic(s) USD MSRP (C)
 30" Kit Includes: Hardware and Single-Sided Graphic(s)
 Hardware includes 4 snap rails for single- or double-sided use

Description	Product Size	Finished Graphic Size	Product Wt. (Single / Double)	Media
24"	24"W x 48"-92"H x 13.25"D	24"W x 12"-92"H	13 lbs. / 14 lbs.	Titan™ 11 mil Polyester
30"	30"W x 48"-92"H x 13.25"D	30"W x 12"-92"H	14 lbs. / 16 lbs.	Titan™ 11 mil Polyester



Everyday hardware available in silver or black. Heavy-Duty and Snap Rail hardware available in black.



Telescoping pole with thumbscrew lets you adjust the hardware for custom banner sizes (call for quote; restrictions may apply).



Each display can hold one or two banners.

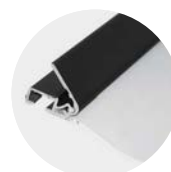

Snap Rail kit offers easy banner installation: just slide the banner into the snap rails and clamp shut.

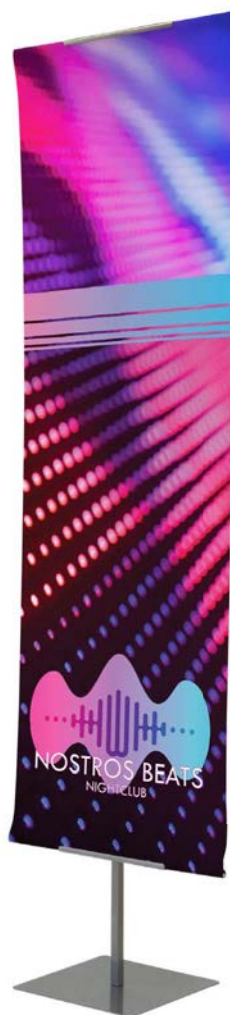

Everyday single-sided kit with silver hardware



Everyday Heavy-Duty double-sided kit



24" Everyday Snap Rail single-sided kit

Prices are subject to change; visit our website for the most current pricing.
 Setup fee: \$20.00(G).
 See pages 208-211 for additional information that may apply to your order.

AFTER FINAL PROOF APPROVAL
 PRODUCTION LEAD TIME IS
2 DAYS



Frame slides together and is held in place by hex set screws.

NEW
RECYCLED
POLYESTER
KNIT

EVERYDAY IMPRESS DISPLAY

Silicone Edge Graphics (SEG) give this display an upscale look that's sure to impress.

- Heavy-duty aluminum frame
- Artwork is dye sublimated on recycled polyester knit
- 100% recycled media is made with REPREVE® fibers
- Includes two graphic panels for a double-sided display
- Two hex wrenches and one open-end wrench included



Everyday Impress Display

Item #	Description	1	2-5	6-11	12-24
210510	Kit	490.75	471.25	456.50	431.75
Kit Includes: Hardware and 2 Graphic Panels					
USD MSRP (C)					

Product Size	Finished Graphic Size	Product Wt.	Media
23.5"W x 73.25"H x 23.5"D	View Online Template	23 lbs.	Recycled Polyester Knit



Includes two graphic panels for a double-sided display.



With a quick press of your thumb, the fabric's gasket edges are pushed into narrow channels built into the frame.



Pull tab lets you quickly remove SEG panel from the frame.



Double-banner

Single-banner with lit racks

Single-banner

NEW
RECYCLED
POLYESTER
KNIT

FLEX BANNER DISPLAY

This display's versatile central post can be customized with banners and lit racks. We've created three kits to get started, but add-ons are interchangeable so you can create your own configuration.

- Artwork is dye sublimated on recycled polyester knit
- 100% recycled media is made with REPREVE® fibers
- Banners are double-sided
- Sturdy aluminum central post and banner rails
- Weighted steel base for stability



Flex Banner Display

Item #	Description	1	2-5	6-11	12-24
263240	Single-Banner Kit	465.75	447.00	433.25	409.75
263245	Single-Banner with Lit Racks Kit	598.00	574.00	556.00	526.00
263243	Double-Banner Kit	641.50	616.00	596.50	564.50
263247	Banner and Rails Add-On	204.40	196.20	190.10	179.80
263248	Lit Racks Add-On (set of 3)	141.00	135.40	131.10	124.10
Kits Includes: Hardware and Double-Sided Graphic(s)					
USD MSRP (C)					

Description	Product Size	Finished Graphic Size	Product Wt.	Media
Single-Banner	27"W x 74"H x 14.75"D	23"W x 64"H	24 lbs.	Recycled Polyester Knit
Single-Banner with Lit Racks	36"W x 74"H x 14.75"D	23"W x 64"H	31 lbs.	Recycled Polyester Knit
Double-Banner	51.5"W x 74"H x 14.75"D	23"W x 64"H	26.25 lbs.	Recycled Polyester Knit



Segmented post pieces fit together and must be secured in place with the included hex wrench.



Banner rails slide into a groove on the central post and can be adjusted for custom banner sizes (call for quote; restrictions may apply).

AFTER FINAL PROOF APPROVAL
PRODUCTION LEAD TIME IS
4 DAYS

Prices are subject to change; visit our website for the most current pricing.
Setup fee: \$20.00(G).
See pages 208-211 for additional information that may apply to your order.

CURVED CANTILEVER BANNER DISPLAY

This cantilevered frame features a stylish arc that allows a double-sided banner to hang freely.

- Durable steel hardware with powder-coated finish
- Banner hooks make graphic changes quick and easy
- Artwork is printed on Titan™ 13 oz. smooth scrim vinyl
- Banner is finished with brass grommets by default; can be customized with nickel or clear plastic grommets by request
- Hex wrench included



Curved Cantilever Banner Display

Item #	Description	1	2-5	6-11	12-24
210175	Kit	302.25	290.25	281.00	266.00
Kit Includes: Hardware and Double-Sided Graphic (24"W x 74"H)				USD MSRP (C)	

Product Size	Finished Graphic Size	Product Wt.	Media
30.25"W x 54.75"-96"H x 14"D	24"W x 46"-84"H	13.75 lbs.	Titan™ 13 oz. Smooth Scrim Vinyl

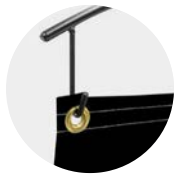

Corner grommets attach to hooks on the display's cantilever arm.



Telescoping pole with thumbscrew lets you adjust the hardware for custom banner sizes (call for quote; restrictions may apply).



EASYSNAP HANGING BANNER

Take advantage of overhead space for indoor ad campaigns with this hanging banner.

- Includes two snap rails to easily mount the banner for a professional look
- Rubber grip tape prevents graphic from slipping
- Artwork is printed on Titan™ 13 oz. smooth scrim vinyl
- Available in three sizes
- Hanging hardware not included

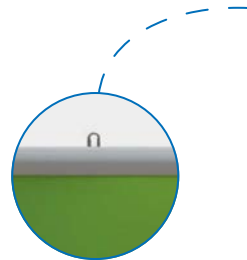

Included hooks slide into the snap rails from the ends (hanging hardware not included).

EasySnap Hanging Banner

Item #	Description	1	2-5	6-11	12-24
263450	24"W x 30"H Double-Sided Kit	88.10	84.60	81.95	77.55
263455	30"W x 40"H Double-Sided Kit	107.00	102.70	99.50	94.10
263460	36"W x 48"H Double-Sided Kit	119.60	114.80	111.20	105.30
Kit Includes: Hardware and Double-Sided Graphic				USD MSRP (C)	

Description	Product Size	Finished Graphic Size	Product Wt.	Media
24"W x 30"H	23.875"W x 32"H x .625"D	23.75"W x 30"H	1.2 lbs.	Titan™ 13 oz. Smooth Scrim Vinyl
30"W x 40"H	30.25"W x 42"H x .625"D	30"W x 40"H	2 lbs.	Titan™ 13 oz. Smooth Scrim Vinyl
36"W x 48"H	36.125"W x 50"H x .625"D	36"W x 48"H	2.6 lbs.	Titan™ 13 oz. Smooth Scrim Vinyl



Prices are subject to change; visit our website for the most current pricing.
Setup fee: \$20.00(G).
See pages 208-211 for additional information that may apply to your order.

AFTER FINAL PROOF APPROVAL
PRODUCTION LEAD TIME IS
2DAYS



5'

4'

3'

2'

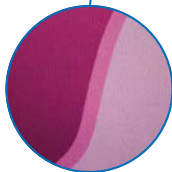

Sustainable recycled polyester knit is made with REPREVE® fibers recycled from plastic bottles.



Graphic cover slides easily over the frame for quick setup.

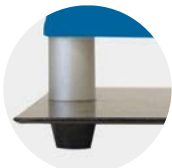

Plastic feet elevate the base and keep the display stable.



EUROFIT BANNER DISPLAY WITH RECYCLED POLYESTER KNIT

A fabric graphic cover slides over a tubed frame, letting you create amazing backdrops or portable privacy walls.

- Multiple sizes can be arranged together for endless display possibilities
- Artwork is dye sublimated on recycled polyester knit
- 100% recycled media is made with REPREVE® fibers
- Double-sided graphic cover is viewable from both the front and back of the display
- Steel base with a black, powder-coated finish
- Not compatible with the EuroFit Connector or EuroFit Cascade Merchandiser kits



EuroFit Banner Display with Recycled Polyester Knit

Item #	Description	1	2-5	6-11	12-24
255110	2' Kit	283.00	274.00	266.00	257.00
255113	3' Kit	389.00	378.00	366.00	354.00
255116	4' Kit	520.00	510.00	491.00	481.00
255119	5' Kit	585.00	570.00	555.00	540.00

Kit Includes: Hardware, Graphic Cover and Soft Carry Case USD MSRP (C)

Description	Product Size	Finished Graphic Size	Product Wt.
2'	25.75"W x 91"H x 10"D	View Online Template	15.5 lbs.
3'	37.75"W x 91"H x 10"D	View Online Template	20.5 lbs.
4'	49"W x 91"H x 10"D	View Online Template	25.5 lbs.
5'	61"W x 91"H x 10"D	View Online Template	31.5 lbs.

AFTER FINAL PROOF APPROVAL
PRODUCTION LEAD TIME IS
4DAYS

Prices are subject to change; visit our website for the most current pricing.
Setup fee: \$20.00(G).
See pages 208-211 for additional information that may apply to your order.



EUROFIT BANNER DISPLAY WITH BIODEGRADABLE MEDIA

Switch out your EuroFit Banner Display with a sustainable, biodegradable media option.

- Multiple sizes can be arranged together for endless display possibilities
- Artwork is dye sublimated on CiCLO® treated polyester fabric
- CiCLO® treated fabric allows the polyester to biodegrade 91.1% compared to untreated polyester
- Double-sided graphic cover is viewable from both the front and back of the display
- Steel base with a black, powder-coated finish
- Not compatible with the EuroFit Connector or EuroFit Cascade Merchandiser kits



EuroFit Banner Display with Biodegradable Media

Item #	Description	1	2-5	6-11	12-24
255140	2' Kit	328.00	318.00	308.00	298.00
255142	3' Kit	436.00	423.00	410.00	396.00
255144	4' Kit	580.00	562.00	546.00	528.00
255146	5' Kit	640.00	621.00	602.00	583.00

Kit Includes: Hardware, Graphic Cover and Soft Carry Case USD MSRP (C)

Description	Product Size	Finished Graphic Size	Product Wt.
2'	25.75"W x 91"H x 10"D	View Online Template	15.5 lbs.
3'	37.75"W x 91"H x 10"D	View Online Template	20.5 lbs.
4'	49"W x 91"H x 10"D	View Online Template	25.5 lbs.
5'	61"W x 91"H x 10"D	View Online Template	31.5 lbs.

Prices are subject to change; visit our website for the most current pricing.
 Setup fee: \$20.00(G).
 See pages 208-211 for additional information that may apply to your order.



CiCLO® is a sustainable textile additive that is combined with the media to create numerous biodegradable areas that can break down as if they were natural fibers.

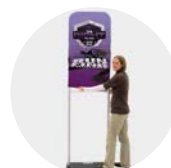

Graphic cover slides easily over the frame for quick setup.



Plastic feet elevate the base and keep the display stable.

AFTER FINAL PROOF APPROVAL
 PRODUCTION LEAD TIME IS
4 DAYS

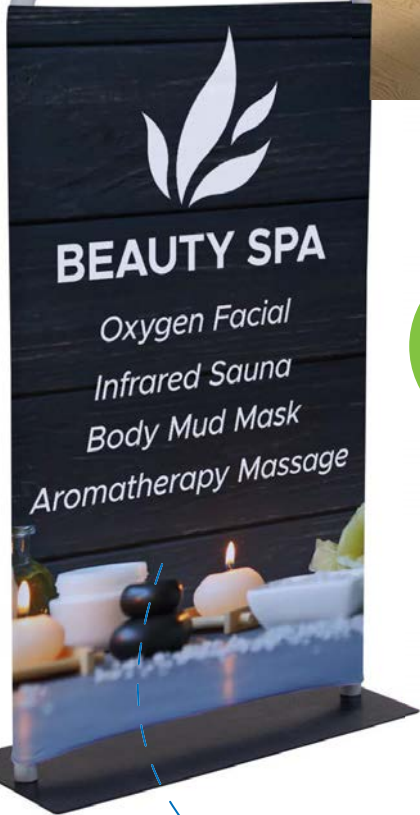

NEW
RECYCLED
POLYESTER
KNIT



Bottom graphic wrap for the 36" kit slips over the frame to maximize your message area.



Double-sided graphic cover slips over the frame like a pillowcase, then zips shut on the top.



EUROFIT ROUND BANNER DISPLAY

Round up your display with this impressively-shaped extension to our EuroFit Banner display product line.

- Artwork is dye sublimated on recycled polyester knit
- 100% recycled media is made with REPREVE® fibers
- Available in two sizes
- 36" includes an additional cover bottom wrap graphic to increase ad space
- Double-sided graphic cover is viewable from both the front and back of the display
- Not compatible with the EuroFit Connector or EuroFit Cascade Merchandiser kits



EuroFit Round Banner Display

Item #	Description	1	2-5	6-11	12-24
256540	36" Round Kit	409.00	392.75	380.50	360.00
256546	60" Round Kit	535.00	513.50	497.50	470.50
36" Kit Includes: Hardware, 2 Graphic Covers and Soft Carry Case				USD MSRP (C)	
60" Kit Includes: Hardware, Graphic Cover and Soft Carry Case					

Description	Product Size	Finished Graphic Size	Product Wt.	Media
36"	36"W x 78"H x 9.875"D	View Online Template	13.4 lbs.	Recycled Polyester Knit
60"	60"W x 77.25"H x 9.875"D	View Online Template	18 lbs.	Recycled Polyester Knit

AFTER FINAL PROOF APPROVAL
PRODUCTION LEAD TIME IS
4DAYS

Prices are subject to change; visit our website for the most current pricing.
Setup fee: \$20.00(G).
See pages 208-211 for additional information that may apply to your order.

Suggested Uses

Trade Shows
Showrooms
Meeting Spaces
Tournaments

NEW
RECYCLED
POLYESTER
KNIT

NEW
& IMPROVED

EUROFIT ANGLE BANNER DISPLAY

Stand out from other displays with this unique angular shape!

- Lightweight aluminum frame
- Available in two sizes
- Artwork is dye sublimated on recycled polyester knit
- 100% recycled media is made with REPREVE® fibers
- Double-sided graphic cover is viewable from both the front and back of the display
- Not compatible with the EuroFit Connector or EuroFit Cascade Merchandiser kits



EuroFit Angle Banner Display

Item #	Description	1	2-5	6-11	12-24
256550	80"H Kit	364.00	353.00	343.00	331.00
256553	100"H Kit	416.00	404.00	391.00	379.00
Kit Includes: Hardware, Graphic Cover and 2 Soft Carry Cases					USD MSRP (C)

Description	Product Size	Finished Graphic Size	Product Wt.	Media
80"H	35.75"W x 79.625"H x 16.5"D	View Online Template	13.5 lbs.	Recycled Polyester Knit
100"H	49"W x 100.5"H x 19.625"D	View Online Template	19 lbs.	Recycled Polyester Knit



100"H

80"H



Easily transport your display with the included soft carry cases.



Sturdy steel base provides stability.

Prices are subject to change; visit our website for the most current pricing.
Setup fee: \$20.00(G).
See pages 208-211 for additional information that may apply to your order.

AFTER FINAL PROOF APPROVAL
PRODUCTION LEAD TIME IS
4 DAYS



NEW
RECYCLED
POLYESTER
KNIT

EUROFIT PRO HANGING BANNER

This hanging banner offers convenient overhead message space in dimensions ideal for retail environments.

- Available in two sizes and two styles
- Lightweight aluminum frame
- Artwork is dye sublimated on recycled polyester knit
- 100% recycled media is made with REPREVE® fibers
- Joints are labeled for step-by-step frame assembly
- Zippered graphic cover is taut and wrinkle-free when installed
- Hanging cables not included (most convention centers will require you to use their designated hanging hardware)



EuroFit Pro Hanging Banner

Item #	Description	1	2-5	6-11	12-24
210282	4' x 12" Round Double-Sided Kit	783.00	751.50	728.00	689.00
210283	4' x 12" Round Bottom Panel Kit	846.00	812.00	786.50	744.50
210287	6' x 20" Round Double-Sided Kit	939.00	901.00	873.00	826.00
210288	6' x 20" Round Bottom Panel Kit	1008.00	968.00	938.00	887.00

Kit Includes: Frame, Graphic Cover and Soft Carry Case USD MSRP (C)

Description	Product Size	Finished Graphic Area	Product Wt. (Double-Sided / Bottom Panel)	Media
4'	12.5"H x 48"D	View Online Template	10.5 lbs. / 11 lbs.	Recycled Polyester Knit
6'	20.25"H x 72"D	View Online Template	18.5 lbs. / 19.75 lbs.	Recycled Polyester Knit

Kit Options



Double-Sided Kit

Your artwork is printed on both the inside and the outside of the graphic cover.



Bottom Panel Kit

Your artwork is printed on the outside of the graphic cover, and the bottom is sealed off with an additional printed panel so the inside remains hidden.

EUROFIT HANGING BANNER

Grab attention from a distance with this three-dimensional hanging banner.

- Available in three shapes and a variety of sizes
- Lightweight aluminum frame
- Artwork is dye sublimated on recycled polyester knit
- 100% recycled media is made with REPREVE® fibers
- Zippered graphic cover is taut and wrinkle-free when installed
- Hanging cables not included (most convention centers will require you to use their designated hanging hardware)



EuroFit Hanging Banner

Item #	Description	1	2-5	6-11	12-24
210150	6' x 36" Round Single-Sided Kit	1296.00	1244.00	1205.00	1140.00
210154	8' x 42" Round Single-Sided Kit	1724.00	1655.00	1603.00	1517.00
210158	10' x 48" Round Single-Sided Kit	2158.00	2072.00	2007.00	1899.00
210162	12' x 48" Round Single-Sided Kit	2486.00	2387.00	2312.00	2188.00
210227	8' x 42" Square Single-Sided Kit	1837.00	1764.00	1708.00	1617.00
210229	8' x 42" Triangle Single-Sided Kit	1510.00	1450.00	1404.00	1329.00

Kit Includes: Frame, Graphic Cover and Soft Carry Case USD MSRP (C)

Description	Product Size	Finished Graphic Area	Product Wt.	Media
6' Round	36"H x 72"D	View Online Template	13.25 lbs.	Recycled Polyester Knit
8' Round	42.13"H x 96"D	View Online Template	17.5 lbs.	Recycled Polyester Knit
10' Round	48"H x 120"D	View Online Template	25.75 lbs.	Recycled Polyester Knit
12' Round	48"H x 144"D	View Online Template	32.5 lbs.	Recycled Polyester Knit
8' Square	96"W x 42"H x 96"D	View Online Template	20 lbs.	Recycled Polyester Knit
8' Triangle	96"W x 42"H x 96"D	View Online Template	17 lbs.	Recycled Polyester Knit



Round

Square

Triangle

AFTER FINAL PROOF APPROVAL
PRODUCTION LEAD TIME IS
4 DAYS

Prices are subject to change; visit our website for the most current pricing.
Setup fee: \$20.00(G).
See pages 208-211 for additional information that may apply to your order.

HEADLINER BANNER DISPLAY

This enormous banner display is great for use in parking lots or at outdoor events.

- Banner available in backlit woven polyester or Titan™ 18 oz. opaque scrim vinyl; face cutout available in vinyl only
- Includes four heavy-duty black stakes
- Adjustable frame hardware is compatible with custom banner heights and widths (call for quote; restrictions may apply)
- Face cutout hole locations are standard and cannot be customized
- Banners used outdoors have a 90-day warranty; banners used indoors have a 1-year warranty



Headliner

Headliner Face Cutout

Headliner Banner Display

Item #	Description	1	2-5	6-11	12-24
263400	Backlit Woven Polyester Single-Sided Kit	1574.00	1511.00	1464.00	1385.00
263401	18 oz. Opaque Scrim Vinyl Single-Sided Kit	1574.00	1511.00	1464.00	1385.00
263402	18 oz. Opaque Scrim Vinyl Double-Sided Kit	1699.00	1631.00	1580.00	1495.00
263272	18 oz. Opaque Scrim Vinyl Quad Face Cutout Kit	1574.00	1511.00	1464.00	1385.00

Kit Includes: Hardware, Graphic, 4 Stakes and Soft Carry Case with Wheels USD MSRP (C)

Description	Product Size	Finished Graphic Size	Product Wt. (Polyester / Vinyl)
Headliner	129.75"W x 85.25"H x 39.5"D	119"W x 76.5"H	56 lbs. / 60 lbs.
Face Cutout	129.75"W x 85.25"H x 39.5"D	View Online Template	NA / 60 lbs.



Thumbscrews on the frame make it easy to set up and adjust.



C-clips attach to clear grommets along the side of the banner to keep it secure.



Heavy-duty steel foot features a handle so it's easy to position during setup.



Banner rail slides into notches in the frame's hubs.

Add-On

Ballasts (sold separately) keep the feet weighted down.

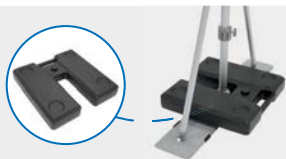

Square Plastic Ballast

Item #	Description	Product Wt.	1	2-5	6-11	12-24
263298	Ballast (set of 2)	37.4 lbs w/water	71.95	69.05	66.90	63.30

USD MSRP (C)

OUTDOOR BALLAST DISPLAY

This attractive outdoor display has a smaller footprint and works well in tight spaces.

- Graphic panel provides plenty of space to display your message
- Artwork is dye sublimated on recycled polyester knit
- 100% recycled media is made with REPREVE® fibers
- Perfect for indoor or short-term outdoor use
- Graphic covers used outdoors have a 90-day warranty; graphic covers used indoors have a 1-year warranty



Outdoor Ballast Display

Item #	Description	1	2-5	6-11	12-24
263420	Kit	623.00	573.00	536.00	498.50

Kit Includes: Hardware, Graphic Cover, 2 Ballasts and Soft Carry Case USD MSRP (C)

Product Size	Finished Graphic Size	Product Wt.	Media
78"W x 59.75"H x 19.5"H	View Online Template	18.5 lbs.	Recycled Polyester Knit



Display foot integrates into the ballast for added stability. Each ballast holds up to 4 gallons of water.



HARDWARE-ONLY LEAD TIME: SHIPS SAME DAY WHEN ORDERED BEFORE 2 PM CENTRAL

Prices are subject to change; visit our website for the most current pricing.
Setup fee: \$20.00(G).
See pages 208-211 for additional information that may apply to your order.

VINYL POLYESTER & BALLAST
AFTER FINAL PROOF APPROVAL PRODUCTION LEAD TIME IS
24 DAYS

BANNERS & FLAGS

When choosing a banner or flag
have you considered...

- **LOCATION** - Will you be using this product indoors or outdoors?
- **USE** - Will you be hanging it on a wall, mounting it on a pole or do you need a standalone display?
- **LONGEVITY** - How long will your banner or flag be displayed?
- **WEATHER** - Are there extreme weather conditions to consider?
- **MESSAGE** - Do you need a single- or double-sided banner or flag?

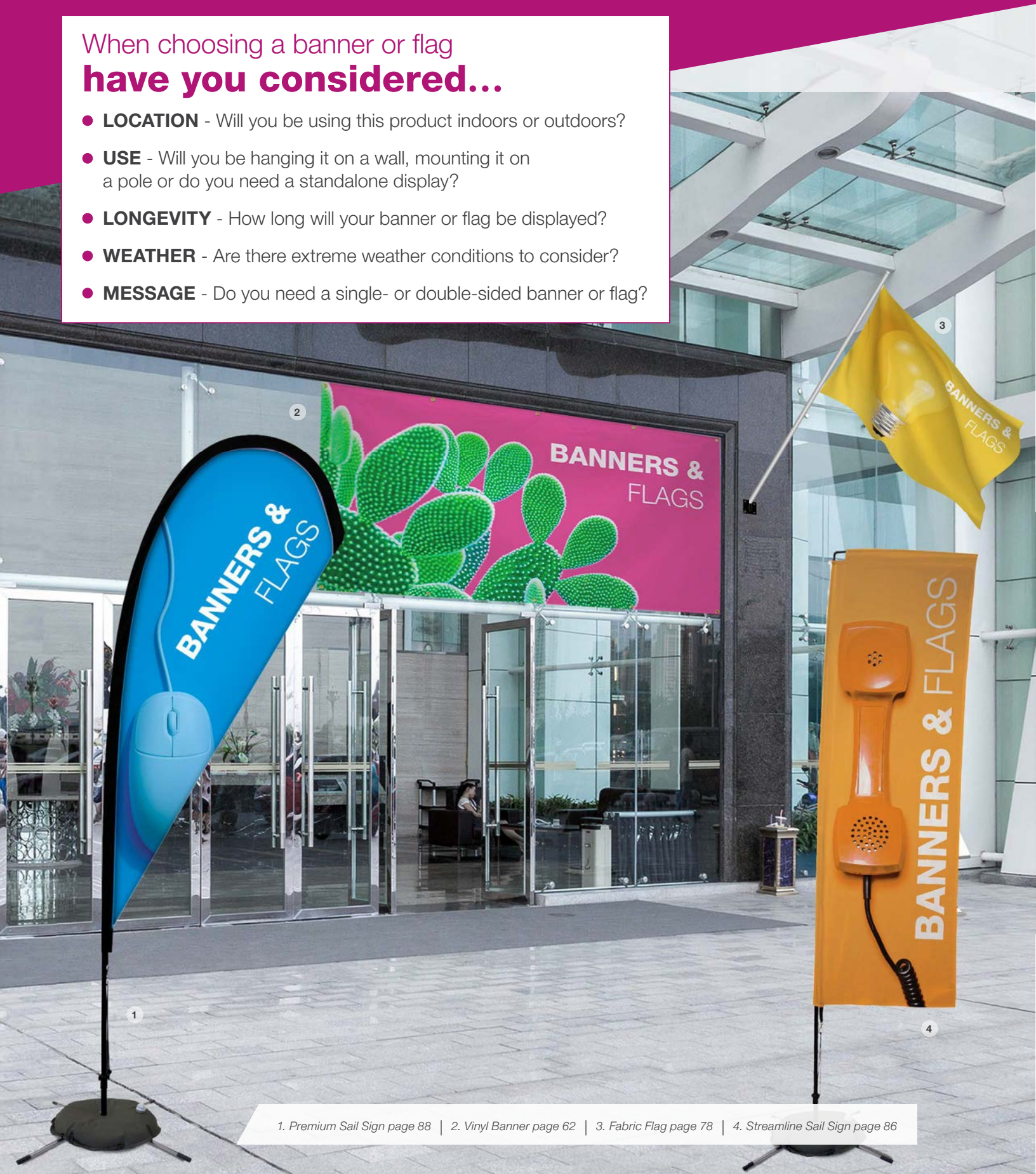

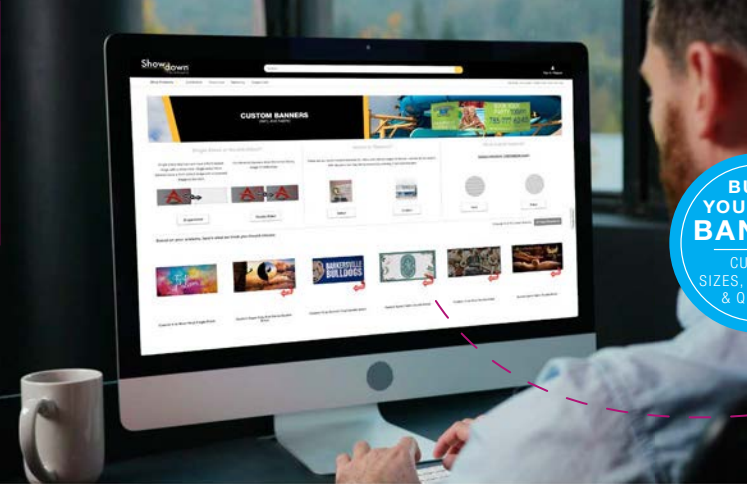

BUILD YOUR OWN BANNERS

WITH OUR QUICK & EASY ONLINE TOOL

Visit our website for accurate quotes and hassle-free ordering 24/7!

Under the Banners & Flags tab, click **Build Your Own Banners**.
 Accurate quoting · Large Quantities · Additional Finishing Styles · Custom Sizes

BANNER MATERIAL COMPARISON CHART

BEST SELLERS ★ SUSTAINABLE ◆	DURABILITY			WIND RATING	INDOOR USE	OUTDOOR USE
	LIGHT	AVERAGE	HEAVY-DUTY			
TITAN™ SCRIM VINYL						
10 oz.	X			5	good	good
13 oz. ★		X		6	better	better
13 oz. Smooth		X		not for outdoor use	BEST	not for outdoor use
18 oz. Opaque ★			X	6	better	BEST
9 oz. Mesh ★			X	6	better	BEST
PVC-FREE						
9 oz. PVC-Free ◆		X		6	better	better
FABRIC						
Nylon		X		6	better	BEST
Polyester Poplin	X			not for outdoor use	BEST	not for outdoor use
Super Poly Knit		X		4	better	better
Satin	X			not for outdoor use	better	not for outdoor use

Beaufort Wind Rating: Select products have been rated on the Beaufort Wind Scale. See rating icon underneath the product name. Wind ratings were determined utilizing all available securing/stabilizing options sold with or offered for the product. Review the Beaufort Scale on page 211 for additional details.

POPULAR FINISHING STYLES

Additional finishing styles available online.

Heat Weld

Single-sided vinyl banners only



HEM & GROMMETS



HEM, ROPE & GROMMETS



3" POLE POCKETS

Sewn

Fabric and double-sided vinyl banners

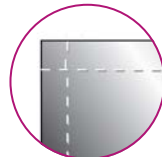

HEM ONLY



HEM & GROMMETS



3" POLE POCKETS

BANNER MATERIAL



SCRIM

Woven threads that provide added strength for a stronger vinyl banner.



SMOOTH

Vinyl without visible scrim texture for higher-quality images.



MESH

A woven vinyl pattern that features small holes so wind can pass through.

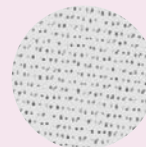

FABRIC

Breathable, lightweight cloth.



3' x 8' banner with rope and grommets

10 OZ. SCRIM VINYL BANNER

This single-sided, light-duty banner is perfect for indoor or short-term outdoor use.

- Multiple finishing styles available (see page 61)
- Banners used outdoors have a 90-day warranty; banners used indoors have a 1-year warranty



10 oz. Scrim Vinyl Banner

Item #	Description	Product Wt.	1-2	3-7	8-22	23-49
304245	2' x 4'	0.5 lb.	33.52	31.51	29.38	27.24
Item #	Description	Product Wt.	1	2-4	5-14	15-33
304247	2' x 6'	1 lb.	50.30	47.30	44.10	40.85
Item #	Description	Product Wt.	1	2-3	4-9	10-22
304252	3' x 6'	1.25 lbs.	75.40	70.90	66.10	61.25
Item #	Description	Product Wt.	1-2	3-7	8-16	17-33
304253	3' x 8'	2 lbs.	94.30	88.55	81.55	72.95
304255	4' x 6'	1.5 lbs.	94.30	88.55	81.55	72.95
Item #	Description	Product Wt.	1	2-5	6-12	13-24
304256	4' x 8'	2 lbs.	125.80	118.10	108.80	97.30

USD MSRP (C)

13 OZ. SCRIM VINYL BANNER

Versatile enough for both indoor and outdoor use, this single-sided banner is a top choice when it comes to value.

- Multiple finishing styles available (see page 61)
- Banners used outdoors have a 90-day warranty; banners used indoors have a 1-year warranty



13 oz. Scrim Vinyl Banner

Item #	Description	Product Wt.	1-2	3-7	8-22	23-49
304360	2' x 4'	1 lb.	35.52	31.97	28.77	26.28
Item #	Description	Product Wt.	1	2-4	5-14	15-33
304361	2' x 6'	2 lbs.	53.30	47.95	43.15	39.45
Item #	Description	Product Wt.	1	2-3	4-9	10-22
304364	3' x 6'	2.5 lbs.	79.90	71.90	64.70	59.15
Item #	Description	Product Wt.	1-2	3-7	8-16	17-33
304365	3' x 8'	3.25 lbs.	97.45	87.70	78.95	72.10
Item #	Description	Product Wt.	1	2-5	6-13	14-26
304366	3' x 10'	4 lbs.	121.80	109.60	98.70	90.10
Item #	Description	Product Wt.	1	2-5	6-12	13-24
304367	4' x 8'	4 lbs.	129.90	116.90	105.20	96.10

USD MSRP (C)



3' x 8' banner with grommets



3' x 6' banner with grommets

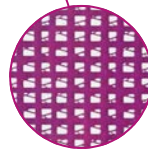

9 OZ. MESH VINYL BANNER

This single-sided banner is made of breathable 60/40 mesh vinyl that excels on breezy days.

- Multiple finishing styles available (see page 61)
- Banners used outdoors have a 90-day warranty; banners used indoors have a 1-year warranty



9 oz. Mesh Vinyl Banner

Item #	Description	Product Wt.	1	2-4	5-14	15-33
304411	2' x 6'	1.25 lbs.	60.70	55.70	51.10	47.30
Item #	Description	Product Wt.	1	2-3	4-9	10-22
304414	3' x 6'	2 lbs.	91.10	83.60	76.70	71.00
Item #	Description	Product Wt.	1-2	3-7	8-18	17-33
304415	3' x 8'	2.5 lbs.	111.80	102.20	94.60	85.40
Item #	Description	Product Wt.	1	2-5	6-13	14-26
304416	3' x 10'	3.25 lbs.	139.80	127.80	118.30	106.80
Item #	Description	Product Wt.	1	2-5	6-12	13-24
304417	4' x 8'	3 lbs.	149.10	136.40	126.20	113.90
Item #	Description	Product Wt.	1	2-4	5-9	10-19
304418	4' x 10'	4.25 lbs.	186.40	170.50	157.80	142.40

USD MSRP (C)



AFTER FINAL PROOF APPROVAL
PRODUCTION LEAD TIME IS
2DAYS

Prices are subject to change; visit our website for the most current pricing.
Setup fee: \$20.00(G).
See pages 208-211 for additional information that may apply to your order.

13 OZ. SMOOTH SCRIM VINYL BANNER

Showcase high-quality print on the extra smooth surface of this indoor banner.

- Multiple finishing styles available (see page 61)
- Banners used indoors have a 1-year warranty

13 oz. Smooth Scrim Vinyl Banner (Single-Sided)

Item #	Description	Product Wt.	1-2	3-7	8-22	23-49
304225	2' x 4'	1 lb.	39.28	35.35	31.95	29.85
Item #	Description	Product Wt.	1	2-3	4-9	10-22
304229	3' x 6'	2 lbs.	88.40	79.55	71.90	67.20
Item #	Description	Product Wt.	1-2	3-7	8-16	17-33
304230	3' x 8'	2.5 lbs.	106.60	95.90	89.10	81.00
304261	4' x 6'	2.5 lbs.	106.60	95.90	89.30	81.00
Item #	Description	Product Wt.	1	2-5	6-12	13-24
304232	4' x 8'	3.5 lbs.	142.10	127.90	118.80	108.00
Item #	Description	Product Wt.	1	2-4	5-9	10-19
304233	4' x 10'	4.25 lbs.	177.60	159.80	148.50	135.00

USD MSRP (C)

13 oz. Smooth Scrim Vinyl Banner (Double-Sided)

Item #	Description	Product Wt.	1-2	3-7	8-22	23-49
304460	2' x 4'	1 lb.	58.70	54.70	50.30	47.35
Item #	Description	Product Wt.	1	2-4	5-16	15-33
304461	2' x 6'	1.25 lbs.	88.10	82.05	75.45	71.05
Item #	Description	Product Wt.	1	2-3	4-9	10-22
304462	3' x 6'	2 lbs.	132.10	123.10	113.10	106.50
Item #	Description	Product Wt.	1-2	3-7	8-16	17-33
304463	3' x 8'	2.5 lbs.	163.90	150.70	141.90	127.90

USD MSRP (C)

18 OZ. OPAQUE SCRIM VINYL BANNER

This banner is reinforced with scrim, making it extremely durable for outdoor use.

- Multiple finishing styles available (see page 61)
- Banners used outdoors have a 90-day warranty; banners used indoors have a 1-year warranty



18 oz. Opaque Scrim Vinyl Banner (Single-Sided)

Item #	Description	Product Wt.	1	2-4	5-14	15-33
304383	3' x 4'	2 lbs.	60.70	55.70	51.10	47.30
Item #	Description	Product Wt.	1	2-3	4-9	10-22
304384	3' x 6'	2.5 lbs.	91.10	83.60	76.70	71.00
Item #	Description	Product Wt.	1-2	3-7	8-16	17-33
304385	3' x 8'	3.25 lbs.	111.60	102.50	94.90	85.30
Item #	Description	Product Wt.	1	2-5	6-13	14-26
304386	3' x 10'	4 lbs.	139.50	128.10	118.60	106.60
Item #	Description	Product Wt.	1	2-5	6-12	13-24
304387	4' x 8'	4 lbs.	148.80	136.70	126.60	113.70
Item #	Description	Product Wt.	1	2-4	5-9	10-19
304388	4' x 10'	5 lbs.	186.00	170.80	158.20	142.10

USD MSRP (C)

18 oz. Opaque Scrim Vinyl Banner (Double-Sided)

Item #	Description	Product Wt.	1-2	3-7	8-22	23-49
304470	2' x 4'	1 lb.	85.75	80.60	74.95	70.40
Item #	Description	Product Wt.	1	2-4	5-14	15-33
304471	2' x 6'	2 lbs.	128.60	120.90	112.40	105.60
Item #	Description	Product Wt.	1	2-3	4-9	10-22
304472	3' x 6'	2.5 lbs.	193.00	181.40	168.70	158.50
Item #	Description	Product Wt.	1-2	3-7	8-16	17-33
304473	3' x 8'	3.25 lbs.	241.40	224.50	211.00	195.10
Item #	Description	Product Wt.	1	2-5	6-12	13-24
304474	4' x 8'	4 lbs.	322.00	299.50	281.50	260.25

USD MSRP (C)



4' x 10' banner with grommets



4' x 8' banner with grommets

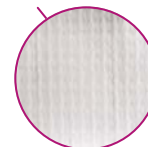
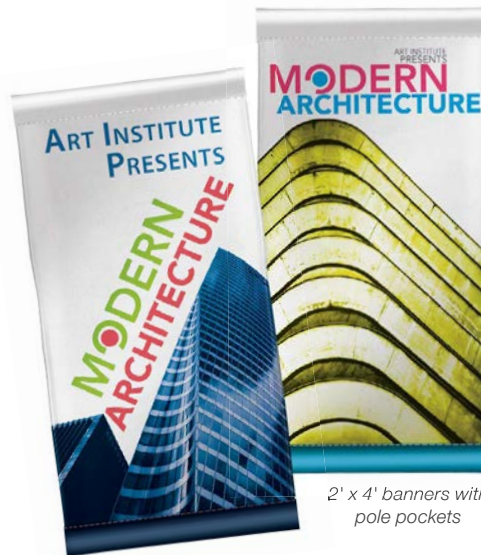

Scrim texture will be subtly visible on the backside of the banner.

2' x 4' banners with pole pockets

Prices are subject to change; visit our website for the most current pricing.
 Setup fee: \$20.00(G).
 See pages 208-211 for additional information that may apply to your order.

AFTER FINAL PROOF APPROVAL
 PRODUCTION LEAD TIME IS
2 DAYS



2' x 4' banner with grommets

Suggested Uses

- City Events
- Schools
- Business Centers
- Sport Arenas

9 OZ. PVC-FREE BANNER

PVC-free banners are an environmentally conscious solution that reduces the impact of PVC on our planet.

- A recyclable and eco-friendly alternative to vinyl banners
- Banners can be used indoors and outdoors
- Artwork is vibrantly printed on 100% PVC-free material
- Only available with sewn finishing style (see page 61)



9 oz. PVC-Free Banner

Item #	Description	Product Wt.	1-2	3-7	8-22	23-49
304970	2' x 4'	1 lb.	44.40	40.54	36.54	34.01
Item #	Description	Product Wt.	1	2-4	5-14	15-33
304971	2' x 6'	1.25 lbs.	66.60	60.80	54.80	51.00
Item #	Description	Product Wt.	1	2-3	4-9	10-22
304972	3' x 6'	2 lbs.	99.90	91.20	82.20	76.50
Item #	Description	Product Wt.	1-2	3-7	8-16	17-33
304973	3' x 8'	2.5 lbs.	121.70	109.70	102.00	91.30
Item #	Description	Product Wt.	1	2-5	6-13	14-26
304974	3' x 10'	3.25 lbs.	152.10	137.00	127.50	114.10
Item #	Description	Product Wt.	1	2-5	6-12	13-24
304975	4' x 8'	3 lbs.	162.20	146.10	136.00	121.70

USD MSRP (C)



FENCE BANNER

Convert your fence into full-color advertisements with this outdoor fence banner.

- Perfect for sporting events or construction sites
- Banner available in mesh fabric or mesh vinyl
- Mesh fabric can be folded for easy transportation and storage; vinyl banners must be rolled
- Banners used outdoors have a 90-day warranty; banners used indoors have a 1-year warranty
- Attach to fence using rope or zip ties (not included)



9 oz. Mesh Vinyl Fence Banner

Item #	Description	Product Wt.	1	2-5	6-11	12-24
304950	10' x 36"	1.5 lbs.	138.40	127.30	119.00	110.70
304951	15' x 36"	2.2 lbs.	206.30	189.80	177.40	165.00
304952	20' x 36"	2.75 lbs.	251.75	231.50	216.50	201.50
304953	10' x 60"	2.4 lbs.	229.00	210.70	196.90	183.20
304954	15' x 60"	3.5 lbs.	314.50	289.25	270.50	251.50
304955	20' x 60"	4.6 lbs.	419.00	385.50	360.25	335.25

USD MSRP (C)

Mesh Fabric Fence Banner

Item #	Description	Product Wt.	1	2-5	6-11	12-24
304960	10' x 36"	0.75 lb.	188.80	173.70	162.40	151.00
304961	15' x 36"	1 lb.	283.25	260.50	243.50	226.50
304962	20' x 36"	1.25 lbs.	377.50	347.25	324.75	302.00
304963	10' x 60"	1 lb.	314.50	289.25	270.50	251.50
304964	15' x 60"	1.5 lbs.	472.00	434.25	406.00	377.50
304965	20' x 60"	2 lbs.	629.00	578.50	541.00	503.00

USD MSRP (C)



Lightweight mesh fabric is perfect for repeated short-term use.

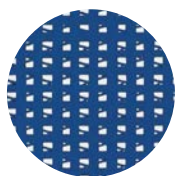

Vinyl mesh is fade resistant and durable; perfect for prolonged outdoor use.

VINYL FABRIC
AFTER FINAL PROOF APPROVAL
PRODUCTION LEAD TIME IS
2 OR 4 DAYS

Prices are subject to change; visit our website for the most current pricing.
Setup fee: \$20.00(G).

See pages 208-211 for additional information that may apply to your order.

SUPER POLY KNIT FABRIC BANNER

This lightweight fabric banner allows wind to pass through, making it great for outdoor use.

- Full-color, dye-sublimated graphics
- Multiple finishing styles available (see page 61)
- Banners used outdoors have a 90-day warranty; banners used indoors have a 1-year warranty



Super Poly Knit Fabric Banner

Item #	Description	Product Wt.	1-2	3-7	8-22	23-49
304420	2' x 4'	0.21 lb.	77.35	69.05	61.90	55.60
Item #	Description	Product Wt.	1	2-4	5-14	15-33
304421	2' x 6'	0.32 lb.	116.00	103.60	92.80	83.40
Item #	Description	Product Wt.	1	2-3	4-9	10-22
304424	3' x 6'	0.48 lb.	174.10	155.50	139.30	125.20
Item #	Description	Product Wt.	1-2	3-7	8-16	17-33
304425	3' x 8'	0.65 lb.	207.10	185.50	166.70	146.70
Item #	Description	Product Wt.	1	2-5	6-12	13-24
304427	4' x 8'	0.86 lb.	276.25	247.50	222.50	195.75
Item #	Description	Product Wt.	1	2-4	5-9	10-19
304430	5' x 8'	1.08 lbs.	345.25	309.25	278.00	244.50

USD MSRP (C)

POLY POPLIN FABRIC BANNER

With high-quality dye-sublimated graphics, this banner is ideal for indoor, close-range viewing.

- Multiple finishing styles available (see page 61)
- Banners used indoors have a 1-year warranty

Poly Poplin Fabric Banner

Item #	Description	Product Wt.	1-2	3-7	8-22	23-49
305000	2' x 4'	0.25 lb.	59.75	55.50	52.45	50.30
Item #	Description	Product Wt.	1	2-5	6-17	18-39
305012	2' x 5'	0.5 lb.	74.70	69.35	65.55	62.85
Item #	Description	Product Wt.	1	2-4	5-14	15-33
305001	2' x 6'	0.5 lb.	89.65	83.25	78.65	75.45
Item #	Description	Product Wt.	1	2-3	4-11	12-26
305002	2' x 8'	0.5 lb.	119.50	111.00	104.90	100.60
305014	3' x 5'	0.5 lb.	112.10	104.10	98.40	94.30
Item #	Description	Product Wt.	1	2-3	4-9	10-22
305004	3' x 6'	1 lb.	134.50	124.90	118.00	113.20
Item #	Description	Product Wt.	1-2	3-7	8-16	17-33
305005	3' x 8'	1 lb.	166.60	157.40	150.90	140.20
Item #	Description	Product Wt.	1	2-5	6-12	13-24
305007	4' x 8'	1 lb.	222.10	209.90	201.20	186.90

USD MSRP (C)

SATIN BANNER

Satin fabric has a formal appearance and an elegant finish, making it a crowd-pleaser at indoor events.

- Full-color, dye-sublimated graphics
- Multiple finishing styles available (see page 61)
- Banners used indoors have a 1-year warranty



Satin Banner

Item #	Description	Product Wt.	1-2	3-7	8-22	23-49
304740	2' x 4'	0.2 lb.	61.30	56.65	52.50	49.45
Item #	Description	Product Wt.	1	2-3	4-9	10-22
304741	3' x 6'	0.45 lb.	137.90	127.40	118.10	111.20
Item #	Description	Product Wt.	1-2	3-7	8-16	17-33
304742	3' x 8'	0.6 lb.	170.20	157.80	148.60	138.20
304743	4' x 6'	0.6 lb.	170.20	157.80	148.60	138.20
Item #	Description	Product Wt.	1	2-5	6-12	13-24
304744	4' x 8'	0.8 lb.	226.90	210.30	198.10	184.20

USD MSRP (C)



3' x 6' banner with custom grommet placement

2' x 4' banner with pole pockets



3' x 8' banner with custom grommet placement



3' x 6' banner with pole pockets



Prices are subject to change; visit our website for the most current pricing.
Setup fee: \$20.00(G).
See pages 208-211 for additional information that may apply to your order.

AFTER FINAL PROOF APPROVAL
PRODUCTION LEAD TIME IS
4 DAYS



Suggested Uses
 Neighborhoods
 Festivals
 Holidays
 College Campuses

BOULEVARD BANNERS

High-quality banners lend an upscale flair to any street or parking lot.

- Finished with 3" pole pockets on top and bottom
- Bracket system sold separately (see page 67)
- Custom sizes available (call for quote; restrictions may apply)
- Banners used outdoors have a 90-day warranty; banners used indoors have a 1-year warranty



Strong Titan™
 18 oz. opaque
 scrim vinyl.

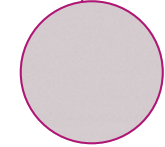
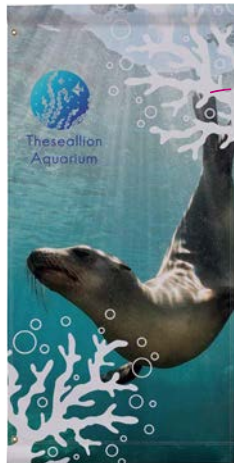

600 denier polyester
 is double-sided with
 block-out liner.



Two grommets
 along one edge
 of the banner.

Vinyl Boulevard Banner (Double-Sided)

Item #	Description	Product Wt.	1-4	5-13	14-39	40-88
302031	18" x 36"	1.12 lbs.	48.24	45.35	42.16	39.61
Item #	Description	Product Wt.	1-3	4-9	10-29	30-66
302033	18" x 48"	1.5 lbs.	64.30	60.45	56.20	52.80
302035	24" x 36"	1.5 lbs.	64.30	60.45	56.20	52.80
Item #	Description	Product Wt.	1-2	3-7	8-22	23-49
302037	24" x 48"	2 lbs.	85.75	80.60	74.95	70.40
Item #	Description	Product Wt.	1	2-5	6-17	18-39
302039	24" x 60"	2.5 lbs.	107.20	100.80	93.70	88.00
Item #	Description	Product Wt.	1	2-4	5-14	15-33
302041	24" x 72"	3 lbs.	128.60	120.90	112.40	105.60
Item #	Description	Product Wt.	1	2-3	4-11	12-24
302043	24" x 96"	4 lbs.	171.50	161.20	149.90	140.80
Item #	Description	Product Wt.	1	2-4	5-14	15-31
302045	30" x 60"	3.12 lbs.	134.00	126.00	117.10	110.00
Item #	Description	Product Wt.	1	2-3	4-11	12-26
302047	30" x 72"	3.75 lbs.	160.80	151.20	140.50	132.00
Item #	Description	Product Wt.	1	2-3	4-10	11-22
302049	30" x 84"	4.5 lbs.	187.60	176.30	164.00	154.00

Banner only. Hardware sold separately (see page 67). USD MSRP (C)
 Single-sided banners are available online.

Fabric Boulevard Banner (Double-Sided)

Item #	Description	Product Wt.	1	2-5	6-11	12-24
302078	18" x 36"	0.6 lb.	176.20	162.10	151.50	141.00
302079	18" x 48"	0.8 lb.	188.80	173.70	162.40	151.00
302080	24" x 36"	0.8 lb.	197.50	181.70	169.90	158.00
302081	24" x 48"	1 lb.	203.90	187.60	175.40	163.10
302082	24" x 60"	1.2 lbs.	216.50	199.20	186.20	173.20
302083	24" x 72"	1.4 lbs.	229.10	210.80	197.00	183.30
302084	24" x 96"	2 lbs.	261.75	240.75	225.00	209.50
302085	30" x 60"	1.6 lbs.	261.75	240.75	225.00	209.50
302086	30" x 72"	1.8 lbs.	281.75	259.25	242.25	225.50
302087	30" x 84"	2 lbs.	288.00	265.00	247.75	230.50

Banner only. Hardware sold separately (see page 67). USD MSRP (C)

VINYL | FABRIC
 AFTER FINAL PROOF APPROVAL
 PRODUCTION LEAD TIME IS
24 DAYS

Prices are subject to change; visit our website for the most current pricing.
 Setup fee: \$20.00(G).
 See pages 208-211 for additional information that may apply to your order.

VERSATILE BRACKET SYSTEM

Designed to be adaptable, this bracket system mounts to most standard wood and steel poles.

- Rust-free cast aluminum with fiberglass arms
- Stainless steel bands hold brackets in place
- Works with square, round, and polygonal poles
- 1° incline keeps banner taut
- Accepts banners up to 24 sq. ft. in size
- Banners sold separately (see page 66)



Versatile Bracket System

Item #	Description	Product Wt.	1-9	10-24	25-49	50-99
302020	18" Single	3 lbs.	114.60	108.90	100.80	96.30
302006	24" Single	3.25 lbs.	115.80	110.00	101.90	97.30
302008	30" Single	3.75 lbs.	120.80	114.80	106.30	101.50
302022	36" Single	4 lbs.	129.60	123.10	114.00	108.90
302021	18" Double	5.25 lbs.	186.20	176.90	163.90	156.40
302007	24" Double	6 lbs.	192.50	182.90	169.40	161.70
302009	30" Double	6.75 lbs.	207.60	197.20	182.70	174.40
302023	36" Double	7.5 lbs.	226.60	215.30	199.40	190.30

Hardware only. Banner sold separately (see page 66). USD MSRP (C)

Cast aluminum brackets



PREMIUM BRACKET SYSTEM

This bracket system is built to withstand the harshest outdoor elements. U.S. Patent# 6378820.

- Premium Single includes two Premium arms (one top, one bottom)
- Premium Double includes four Premium arms (two top, two bottom)
- Premium Single with Spring Arm includes one top Premium arm and one bottom spring arm
- Premium Double with Spring Arm includes two top Premium arms and two bottom spring arms
- Banners sold separately (see page 66)



The spring arm has a 1° incline to keep banners taut and easily snaps back into place after banner changes.

Premium Bracket System

Item #	Description	Product Wt.	1	2-5	6-11	12-24
302060	30" Single	5.25 lbs.	145.90	134.20	125.50	116.70
302061	30" Double	10 lbs.	247.90	228.10	213.20	198.30

Hardware only. Banner sold separately (see page 66). USD MSRP (C)

Premium Bracket System with Spring Arm

Item #	Description	Product Wt.	1	2-5	6-11	12-24
302062	30" Single w/Spring Arm	6 lbs.	183.70	169.00	158.00	147.00
302063	30" Double w/Spring Arm	11.5 lbs.	313.25	288.25	269.50	250.50

Hardware only. Banner sold separately (see page 66). USD MSRP (C)

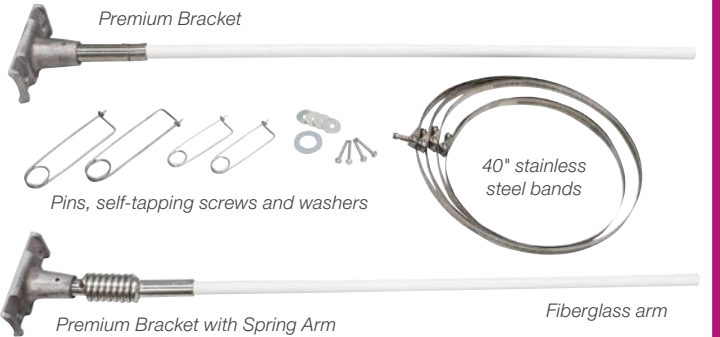

WALL-MOUNT BRACKET SYSTEM

Rust-free cast aluminum brackets let you attach a banner to any wall, whether indoors or out.

- Banners sold separately (see page 66)



Wall-Mount Bracket System

Item #	Description	Product Wt.	1	10	100	250
302200	18" Bracket System	3.5 lbs.	95.65	90.85	84.15	80.35
302201	24" Bracket System	4 lbs.	95.65	90.85	84.15	80.35
302202	30" Bracket System	6 lbs.	95.65	90.85	84.15	80.35
302203	36" Bracket System	6.5 lbs.	95.65	90.85	84.15	80.35

Hardware only; screws/bolts not included. USD MSRP (C)



Bracket can be attached to a wall using screws or bolts (not included).





3' x 8' with straight bottom and gold fringe

PARADE BANNER

Bring attention to your organization at parades and events.

- Great for parades, marching bands, organizations, schools and companies
- Available in two shapes; straight and scallop bottom
- Banner is double-sided on recycled polyester knit
- 100% recycled media is made with REPREVE® fibers
- Backside can be flooded with matching color; no other print design allowed
- Interior liner added to prevent wind distortion
- Select banner with or without gold fringe along the bottom
- Included sectional aluminum pole allows for banner to be carried with ease



3' x 6' with straight bottom

3' x 6' with scallop bottom



Enrich the look of your banner by choosing a banner option with gold fringe.

Parade Banner

Item #	Description	Product Wt.	1	2-5	6-11	12-24
286200	3' x 6' Straight Bottom Kit	3.9 lbs.	308.25	283.50	265.00	246.50
286201	3' x 6' Straight Bottom Kit w/ Gold Fringe	4.1 lbs.	333.75	307.00	287.00	267.00
286202	3' x 6' Scallop Bottom Kit	3.6 lbs.	308.25	283.50	265.00	246.50
286203	3' x 6' Scallop Bottom Kit w/ Gold Fringe	3.9 lbs.	333.75	307.00	287.00	267.00
286209	3' x 8' Straight Bottom Kit	4.8 lbs.	387.75	356.75	333.50	310.25
286210	3' x 8' Straight Bottom Kit w/ Gold Fringe	5.2 lbs.	419.00	385.50	360.25	335.25
286211	3' x 8' Scallop Bottom Kit	4.4 lbs.	387.75	356.75	333.50	310.25
286212	3' x 8' Scallop Bottom Kit w/ Gold Fringe	5 lbs.	419.00	385.50	360.25	335.25
286218	3' x 10' Straight Bottom Kit	6.15 lbs.	465.75	428.50	400.50	372.50
286219	3' x 10' Straight Bottom Kit w/ Gold Fringe	7 lbs.	497.00	457.25	427.50	397.50
286220	3' x 10' Scallop Bottom Kit	5.7 lbs.	465.75	428.50	400.50	372.50
286221	3' x 10' Scallop Bottom Kit w/ Gold Fringe	6.7 lbs.	497.00	457.25	427.50	397.50

Kit Includes: Pole Hardware and Graphic USD MSRP (C)



For best results, push swedge poles into the ground and hold the top half of each side to keep it taut.



TEARAWAY BANNER



Create a grand entrance at sporting events with a Tearaway Banner. Burst it apart and put it back together again!

- Artwork is printed on recycled polyester knit
- 100% recycled media is made with REPREVE® fibers
- The tearaway banner is made of two panels that attach to one another using hook-and-loop fasteners
- Each panel features a 3" pole pocket along the edge; pole pockets are closed at the top to prevent the banner from sliding down the poles
- Double-needle hem along the non-pole-pocket edge
- Banners used outdoors have a 90-day warranty; banners used indoors have a 1-year warranty



Tearaway Banner

Item #	Description	Product Wt.	1	2-5	6-11	12-24
304680	6' x 10' Kit	3 lbs.	484.50	445.75	416.75	387.50
304682	8' x 12' Kit	7.5 lbs.	730.00	671.50	628.00	584.00
304684	10' x 15' Kit	6.5 lbs.	1039.00	956.00	894.00	831.00

Kit Includes: Hardware, (2) 12' Rope and Graphic USD MSRP (C)

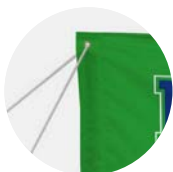

Included rope loops through grommets to keep the banner secure and taut.



Hook-and-loop fasteners are strong enough to hold the two panels together but make the banner easy to burst through.

AFTER FINAL PROOF APPROVAL
PRODUCTION LEAD TIME IS
4 DAYS

Prices are subject to change; visit our website for the most current pricing.
Setup fee: \$20.00(G).
See pages 208-211 for additional information that may apply to your order.

BUILD YOUR OWN FLAGS

WITH OUR QUICK & EASY ONLINE TOOL









Visit our website for accurate quotes and hassle-free ordering 24/7!

Under the Banners & Flags tab, click **Build Your Own Flags**.

Accurate quoting · Large Quantities (max 50) · Additional Finishing Styles · Custom Sizes



FLAG MATERIAL COMPARISON CHART

BEST SELLERS ★	MATERIAL CONSTRUCTION	WIND RATING	BEST USE	COLOR FASTNESS	REVERSE SIDE COLOR	SHAPES
200 Denier Nylon ★	 Tightly woven threads provide better longevity and hold color longer.		Recommended for Indoor and Outdoor Use	★★★★	 Reverse image will show through on back; color is vibrant on both sides.	
Super Poly Knit ★	 Knitted fibers create a lightweight material that holds up well in windy conditions.		Recommended for Outdoor Use	★★★	 Reverse image will show through on back; color is muted on back side.	

 **Beaufort Wind Rating:** Select products have been rated on the Beaufort Wind Scale. See rating icon underneath the product name. Wind ratings were determined utilizing all available securing/stabilizing options sold with or offered for the product. Review the Beaufort Scale on page 211 for additional details.

POPULAR FINISHING STYLES

Details and additional finishing styles available online.

Header

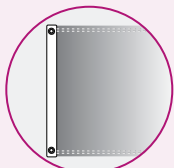

CANVAS HEADER & GROMMETS
(Standard Finishing)

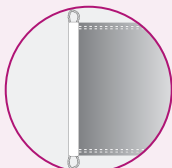

CANVAS HEADER & ROPE/THIMBLE
(Recommended for flags that are 8' x 12' or larger)

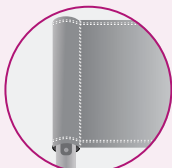

3" POLE SLEEVE VISIBLE, CLOSED AT TOP, LEATHER TAB

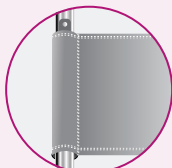

3" POLE SLEEVE VISIBLE, OPEN AT TOP, LEATHER TAB

Edges

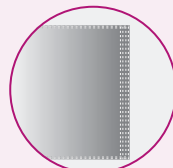

4-ROW LOCK-STITCHING

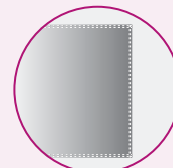

DOUBLE NEEDLE LOCK-STITCHING

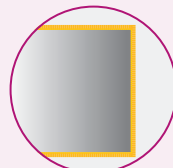

GOLD FRINGE

NYLON FLAG

Lightweight and fade-resistant, our nylon flags come in a variety of shapes and sizes and are perfect for indoor and outdoor use.

- Constructed of 200 denier nylon
- Standard finishing includes canvas header and brass grommets
- Four rows of lock-stitching provide extra reinforcement on the fly end of rectangular flags
- Single- and double-sided options available
- Flags that are 8' x 12' and larger contain lap seams
- Custom sizes and finishing available (visit website or call for quote; restrictions may apply)
- Flags used outdoors have a 90-day warranty; flags used indoors have a 1-year warranty



Rectangle: The oldest and most common shape in advertising

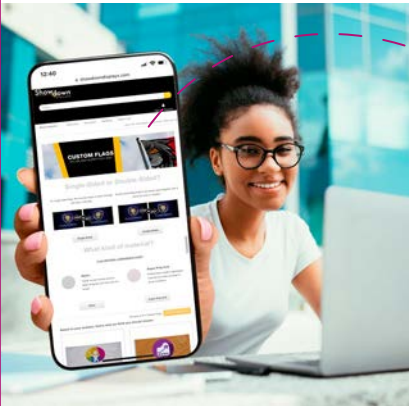

Rectangle Nylon Flag (Single-Sided)

Item #	Description	Product Wt.	1	2-5	6-11	12-24
304530	8" x 12"	0.25 lb.	45.30	36.24	33.98	29.45
304531	12" x 18"	0.25 lb.	50.35	40.30	37.75	32.75
304532	16" x 24"	0.25 lb.	55.40	44.30	41.55	36.00
304533	2' x 3'	0.3 lb.	62.90	50.30	47.20	40.90
304534	2.5' x 4'	0.4 lb.	88.10	70.50	66.10	57.25
304535	3' x 5'	0.5 lb.	100.70	80.60	75.50	65.50
304536	4' x 6'	0.7 lb.	138.40	110.70	103.80	90.00
304537	5' x 8'	1 lb.	201.30	161.00	151.00	130.80
304538	6' x 10'	1.6 lbs.	289.50	231.50	217.25	188.25
304539	8' x 12'	2.9 lbs.	491.00	392.75	368.25	319.25
304540	10' x 15'	4.6 lbs.	818.00	654.50	613.50	531.50
304541	12' x 18'	6.5 lbs.	1196.00	957.00	897.00	777.00
304542	15' x 25'	13.25 lbs.	1762.00	1410.00	1322.00	1145.00
304543	20' x 30'	21 lbs.	3146.00	2517.00	2360.00	2045.00
304544	20' x 38'	26.6 lbs.	3775.00	3020.00	2831.00	2454.00
304545	25' x 40'	35 lbs.	4782.00	3826.00	3587.00	3108.00
304546	30' x 50'	52.5 lbs.	6670.00	5335.00	5005.00	4335.00
304547	30' x 60'	63 lbs.	8180.00	6545.00	6135.00	5315.00

USD MSRP (C)

Rectangle Nylon Flag (Double-Sided)

Item #	Description	Product Wt.	1	2-5	6-11	12-24
304550	8" x 12"	0.75 lb.	90.60	72.50	67.95	58.90
304551	12" x 18"	0.75 lb.	100.70	80.60	75.50	65.50
304552	16" x 24"	0.75 lb.	110.80	88.60	83.10	72.00
304553	2' x 3'	0.9 lb.	125.80	100.60	94.40	81.80
304554	2.5' x 4'	1.2 lbs.	176.20	141.00	132.20	114.50
304555	3' x 5'	1.5 lbs.	201.30	161.00	151.00	130.80
304556	4' x 6'	2.1 lbs.	277.00	221.50	207.75	180.00
304557	5' x 8'	3 lbs.	402.75	322.25	302.00	261.75
304558	6' x 10'	4.8 lbs.	579.00	463.00	434.50	376.50

USD MSRP (C)

Single-Sided



Single-sided flags are printed on one side; reverse image shows through the back.

Double-Sided



Double-sided flags have the image printed correctly on both sides with a block-out polyester liner.

AFTER FINAL PROOF APPROVAL
PRODUCTION LEAD TIME IS
4 DAYS

Prices are subject to change; visit our website for the most current pricing.
Setup fee: \$20.00(G).
See pages 208-211 for additional information that may apply to your order.

Pennant Nylon Flag (Single-Sided)

Item #	Description	Product Wt.	1	2-5	6-11	12-24
304600	8" x 12"	0.25 lb.	45.30	36.24	33.98	29.45
304601	12" x 18"	0.25 lb.	50.35	40.30	37.75	32.75
304602	16" x 24"	0.25 lb.	55.40	44.30	41.55	36.00
304603	2' x 3'	0.25 lb.	62.90	50.30	47.20	40.90
304604	2.5' x 4'	0.4 lb.	88.10	70.50	66.10	57.25
304605	3' x 5'	0.5 lb.	100.70	80.60	75.50	65.50
304606	4' x 6'	0.7 lb.	138.40	110.70	103.80	90.00
304607	5' x 8'	1 lb.	201.30	161.00	151.00	130.80
304608	6' x 10'	1.6 lbs.	289.50	231.50	217.25	188.25

USD MSRP (C)

Pennant Nylon Flag (Double-Sided)

Item #	Description	Product Wt.	1	2-5	6-11	12-24
304610	8" x 12"	0.75 lb.	90.60	72.50	67.95	58.90
304611	12" x 18"	0.75 lb.	100.70	80.60	75.50	65.50
304612	16" x 24"	0.75 lb.	110.80	88.60	83.10	72.00
304613	2' x 3'	0.75 lb.	125.80	100.60	94.40	81.80
304614	2.5' x 4'	1.2 lbs.	176.20	141.00	132.20	114.50
304615	3' x 5'	1.5 lbs.	201.30	161.00	151.00	130.80
304616	4' x 6'	2.1 lbs.	277.00	221.50	207.75	180.00
304617	5' x 8'	3 lbs.	402.75	322.25	302.00	261.75
304618	6' x 10'	4.8 lbs.	579.00	463.00	434.50	376.50

USD MSRP (C)

Guidon Nylon Flag (Single-Sided)

Item #	Description	Product Wt.	1	2-5	6-11	12-24
304580	8" x 12"	0.25 lb.	45.30	36.24	33.98	29.45
304581	12" x 18"	0.25 lb.	50.35	40.30	37.75	32.75
304582	16" x 24"	0.25 lb.	55.40	44.30	41.55	36.00
304589	20" x 27.75"	0.2 lb.	60.40	48.30	45.30	39.25
304583	2' x 3'	0.25 lb.	62.90	50.30	47.20	40.90
304584	2.5' x 4'	0.4 lb.	88.10	70.50	66.10	57.25
304585	3' x 5'	0.5 lb.	100.70	80.60	75.50	65.50
304586	4' x 6'	0.7 lb.	138.40	110.70	103.80	90.00
304587	5' x 8'	1 lb.	201.30	161.00	151.00	130.80
304588	6' x 10'	1.6 lbs.	289.50	231.50	217.25	188.25

USD MSRP (C)

Guidon Nylon Flag (Double-Sided)

Item #	Description	Product Wt.	1	2-5	6-11	12-24
304590	8" x 12"	0.75 lb.	90.60	72.50	67.95	58.90
304591	12" x 18"	0.75 lb.	100.70	80.60	75.50	65.50
304592	16" x 24"	0.75 lb.	110.80	88.60	83.10	72.00
304609	20" x 27.75"	0.4 lb.	120.80	96.60	90.60	78.50
304593	2' x 3'	0.75 lb.	125.80	100.60	94.40	81.80
304594	2.5' x 4'	1.2 lbs.	176.20	141.00	132.20	114.50
304595	3' x 5'	1.5 lbs.	201.30	161.00	151.00	130.80
304596	4' x 6'	2.1 lbs.	277.00	221.50	207.75	180.00
304597	5' x 8'	3 lbs.	402.75	322.25	302.00	261.75
304598	6' x 10'	4.8 lbs.	579.00	463.00	434.50	376.50

USD MSRP (C)

Burgee Nylon Flag (Single-Sided)

Item #	Description	Product Wt.	1	2-5	6-11	12-24
304560	8" x 12"	0.25 lb.	45.30	36.24	33.98	29.45
304561	12" x 18"	0.25 lb.	50.35	40.30	37.75	32.75
304562	16" x 24"	0.25 lb.	55.40	44.30	41.55	36.00
304563	2' x 3'	0.25 lb.	62.90	50.30	47.20	40.90
304564	2.5' x 4'	0.4 lb.	88.10	70.50	66.10	57.25
304565	3' x 5'	0.5 lb.	100.70	80.60	75.50	65.50
304566	4' x 6'	0.7 lb.	138.40	110.70	103.80	90.00
304567	5' x 8'	1 lb.	201.30	161.00	151.00	130.80
304568	6' x 10'	1.6 lbs.	289.50	231.50	217.25	188.25

USD MSRP (C)

Burgee Nylon Flag (Double-Sided)

Item #	Description	Product Wt.	1	2-5	6-11	12-24
304570	8" x 12"	0.75 lb.	90.60	72.50	67.95	58.90
304571	12" x 18"	0.75 lb.	100.70	80.60	75.50	65.50
304572	16" x 24"	0.75 lb.	110.80	88.60	83.10	72.00
304573	2' x 3'	0.75 lb.	125.80	100.60	94.40	81.80
304574	2.5' x 4'	1.2 lbs.	176.20	141.00	132.20	114.50
304575	3' x 5'	1.5 lbs.	201.30	161.00	151.00	130.80
304576	4' x 6'	2.1 lbs.	277.00	221.50	207.75	180.00
304577	5' x 8'	3 lbs.	402.75	322.25	302.00	261.75
304578	6' x 10'	4.8 lbs.	579.00	463.00	434.50	376.50

USD MSRP (C)



Pennant: Most often used for identifying athletic teams



Guidon: Commonly used for promoting military units



Burgee: Traditionally used for signaling and identifying watercraft

Prices are subject to change; visit our website for the most current pricing.
 Setup fee: \$20.00(G).
 See pages 208-211 for additional information that may apply to your order.

AFTER FINAL PROOF APPROVAL
 PRODUCTION LEAD TIME IS
4 DAYS

UNITED STATES FLAG

Let your patriotism fly high with these beautifully constructed durable flags.

- Flags are constructed of the finest nylon, special woven two-ply polyester or polycotton
- Dyed with UV protected fade-resistant inks for longer-lasting colors with seamless transitions
- Nylon and polyester flags feature embroidered stars and hand-sewn stripes for an authentic high-quality flag
- Polycotton flag is a 100% printed flag
- Superior wearing quality dries quickly and stands up to the elements
- Call your rep for lead times on USA Flags larger than 8' x 12'
- Flags used outdoors have a 90-day warranty; flags used indoors have a 1-year warranty



Suggested Uses

- Colleges
- Businesses
- Sporting Events
- Fairs



United States Nylon Flag

Item #	Description	Product Wt.	1
48402	2' x 3'	0.3 lb.	20.77
48403	3' x 5'	0.6 lb.	43.92
48404	4' x 6'	0.85 lb.	61.10
48405	5' x 8'	1.3 lbs.	88.89
484059	5' x 9.5'	1.5 lbs.	112.40
48406	6' x 10'	1.9 lbs.	138.36
48408	8' x 12'	3.1 lbs.	256.50
48410	10' x 15'	5.3 lbs.	376.98

USD MSRP (C)

United States Polyester Flag

Item #	Description	Product Wt.	1
48803	3' x 5'	1 lb.	55.15
48804	4' x 6'	1.5 lbs.	72.60
48805	5' x 8'	2.2 lbs.	112.80
48806	6' x 10'	3.3 lbs.	169.80
48808	8' x 12'	5.3 lbs.	286.75
48810	10' x 15'	8.5 lbs.	440.50
48812	12' x 18'	11.9 lbs.	639.00
48815	15' x 25'	19.7 lbs.	1071.00

USD MSRP (C)

United States Polycotton Flag

Item #	Description	Product Wt.	1
484000	3' x 5'	0.4 lb.	22.88

USD MSRP (C)

Nylon & Polyester United States Flags Feature

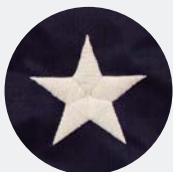

Flags feature full white embroidered stars, no gaps.

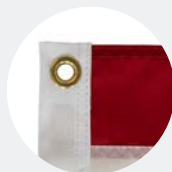

Flags up to 6'x10' are finished with a white canvas header and brass grommets; 8'x12' and larger are finished with a rope and thimble header.

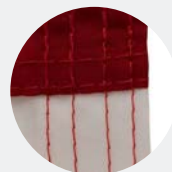

Fly end is finished with four-row lock-stitching.



Flags utilize a quarter-inch turn-in on all seams to reduce fraying.

**SHIPS
SAME DAY**
WHEN ORDERED BEFORE 2 PM CENTRAL

CALL YOUR REP FOR LEAD TIMES ON USA FLAGS LARGER THAN 8' X 12'

Prices are subject to change; visit our website for the most current pricing. See pages 208-211 for additional information that may apply to your order.



MILITARY FLAGS

Show your military pride with a flag representing the branch you support or serve.

- Constructed of 200 denier nylon
- Choose from all standard military branches and POW/MIA flags
- Military branch flags are single-sided
- POW/MIA flags are available single- and double-sided
- Great for indoor or outdoor use
- Great flyability, even in the slightest breeze
- Finished with canvas header and brass grommets
- Flags used outdoors have a 90-day warranty; flags used indoors have a 1-year warranty



POW/MIA

POW/MIA Flag

Item #	Description	Product Wt.	1
424PO02	2' x 3' Flag Single-Sided	0.25 lb.	22.65
424PO02D	2' x 3' Flag Double-Sided	0.9 lb.	47.82
424PO03	3' x 5' Flag Single-Sided	0.5 lb.	40.27
424PO03B	3' x 5' Flag Double-Sided	1.5 lbs.	84.30
424PO04	4' x 6' Flag Single-Sided	0.7 lb.	61.65
424PO04D	4' x 6' Flag Double-Sided	2.1 lbs.	129.60
424PO05	5' x 8' Flag Single-Sided	1 lb.	104.50
424PO05D	5' x 8' Flag Double-Sided	3 lbs.	220.30
424PO06	6' x 10' Flag Single-Sided	1.6 lbs.	151.00
424PO06D	6' x 10' Flag Double-Sided	4.8 lbs.	317.25

USD MSRP (C)



U.S. Marine Corps



U.S. Army



U.S. Navy



U.S. Coast Guard



U.S. Air Force

Military Flags

Item #	Description	Product Wt.	1
285810	2' x 3'	0.25 lb.	22.65
285811	3' x 5'	0.5 lb.	40.27
285812	4' x 6'	0.7 lb.	61.65
285813	5' x 8'	1 lb.	104.50
285814	6' x 10'	1.6 lbs.	151.00

USD MSRP (C)

Prices are subject to change; visit our website for the most current pricing. See pages 208-211 for additional information that may apply to your order.

POW/MIA AFTER FINAL PROOF APPROVAL PRODUCTION LEAD TIME IS | MILITARY SHIPS OR SAME DAY WHEN ORDERED BEFORE 2 PM CENTRAL

4 DAYS

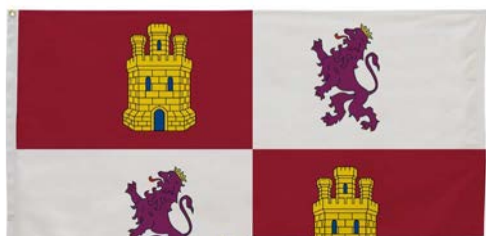

Lions & Castles



Raven



Washington Commander in Chief

**MORE
OPTIONS**
AVAILABLE
ONLINE

HISTORICAL FLAGS

Travel back in time and capture an important moment with these nylon flags.

- Great for indoor or outdoor use
- Artwork is printed on 200 denier nylon
- Finished with canvas header and brass grommets
- Flags are single-sided
- Great flyability, even in the slightest breeze
- See the complete selection of Historical Flags available online
- Flags used outdoors have a 90-day warranty; flags used indoors have a 1-year warranty



Historical Flags

Item #	Description	Product Wt.	1
286020	2' x 3'	0.25 lb.	31.46
286021	3' x 5'	0.5 lb.	56.65
286022	4' x 6'	0.7 lb.	79.30
286023	5' x 8'	1 lb.	118.40
286024	6' x 10'	1.6 lbs.	176.20

USD MSRP (C)



**MORE
OPTIONS**
AVAILABLE
ONLINE

INTERNATIONAL FLAGS

Rugged enough to withstand outdoor use, these single-sided flags feature brilliant colors to showcase the nation of your choosing.

- Great for indoor or outdoor use
- Artwork is printed on 200 denier nylon
- Finished with canvas header and brass grommets
- Great flyability, even in the slightest breeze
- See the complete selection of International Flags available online
- Flags used outdoors have a 90-day warranty; flags used indoors have a 1-year warranty



International Flags

Item #	Description	Product Wt.	1
285820	2' x 3'	0.25 lb.	31.46
285821	3' x 5'	0.5 lb.	56.65
285822	4' x 6'	0.7 lb.	79.30
285823	5' x 8'	1 lb.	118.40
285824	6' x 10'	1.6 lbs.	176.20

USD MSRP (C)

AFTER FINAL PROOF APPROVAL
PRODUCTION LEAD TIME IS
4DAYS

Prices are subject to change; visit our website for the most current pricing.
See pages 208-211 for additional information that may apply to your order.

STATE FLAGS

Fly your state flag with pride and let us know where you're from. We offer flags for all 50 states as well as U.S. territories.

- Great for indoor or outdoor use
- Artwork is printed on 200 denier nylon
- Finished with canvas header and brass grommets
- Flags are single-sided
- Great flyability, even in the slightest breeze
- See the complete selection of State Flags available online
- Flags used outdoors have a 90-day warranty; flags used indoors have a 1-year warranty



**MORE
OPTIONS**
AVAILABLE
ONLINE

Arizona

Hawaii

South Carolina

State Flags

Item #	Description	Product Wt.	1
285800	2' x 3'	0.25 lb.	22.65
285801	3' x 5'	0.5 lb.	40.27
285802	4' x 6'	0.7 lb.	61.65
285803	5' x 8'	1 lb.	104.50
285804	6' x 10'	1.6 lbs.	151.00

USD MSRP (C)

CITY FLAGS

These brilliantly dyed nylon flags are built to last and feature prominent cities across the U.S.

- Great for indoor or outdoor use
- Artwork is printed on 200 denier nylon
- Finished with canvas header and brass grommets
- Flags are single-sided
- Great flyability, even in the slightest breeze
- See the complete selection of City Flags available online
- Flags used outdoors have a 90-day warranty; flags used indoors have a 1-year warranty



**MORE
OPTIONS**
AVAILABLE
ONLINE



Pittsburgh

Anchorage

Wichita

City Flags

Item #	Description	Product Wt.	1
286001	2' x 3'	0.25 lb.	31.46
286002	3' x 5'	0.5 lb.	56.65
286003	4' x 6'	0.7 lb.	79.30
286004	5' x 8'	1 lb.	118.40
286005	6' x 10'	1.6 lbs.	176.20

USD MSRP (C)

Prices are subject to change; visit our website for the most current pricing. See pages 208-211 for additional information that may apply to your order.

AFTER FINAL PROOF APPROVAL
PRODUCTION LEAD TIME IS
4 DAYS

**MORE
OPTIONS**
AVAILABLE
ONLINE



Presbyterian



Israel Zion

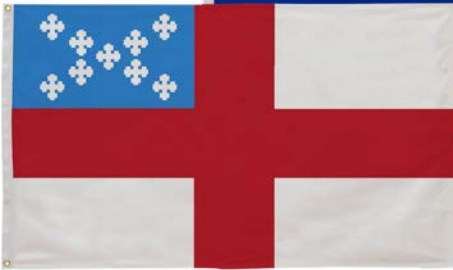

Episcopal

RELIGIOUS FLAGS

These reverent flags will look great outside your place of worship.

- Great for indoor or outdoor use
- Artwork is printed on 200 denier nylon
- Finished with canvas header and brass grommets
- Flags are single-sided
- Great flyability, even in the slightest breeze
- See the complete selection of Religious Flags available online
- Flags used outdoors have a 90-day warranty; flags used indoors have a 1-year warranty



Religious Flags

Item #	Description	Product Wt.	1
286010	2' x 3'	0.25 lb.	31.46
286011	3' x 5'	0.5 lb.	56.65
286012	4' x 6'	0.7 lb.	79.30
286013	5' x 8'	1 lb.	118.40
286014	6' x 10'	1.6 lbs.	176.20

USD MSRP (C)



SOLID-COLOR FLAG

These brilliantly colored flags command attention in any environment.

- Standard finishing includes canvas header and brass grommets
- Constructed of 200 denier nylon
- Four rows of lock-stitching provide extra reinforcement on the fly end of the flag
- Great for indoor or outdoor use
- Features a single stock color across the entire flag
- 26 color options to choose from
- Flags used outdoors have a 90-day warranty; flags used indoors have a 1-year warranty



STOCK FLAG COLORS

- Bell Blue PMS 641
- French Blue PMS 285
- Pansy PMS 2617
- Black
- Gray PMS 7538
- Purple PMS 2695
- Buff PMS 141
- Irish Green PMS 349
- Royal Blue PMS 286
- Canada Red PMS 186
- Legion Blue PMS 2756
- Silver PMS 7534
- Charcoal PMS 424
- Maroon PMS 5115
- Spice Brown PMS 1545
- Daffodil PMS 108
- Mint Green PMS 360
- Spanish Yellow PMS 1235
- Dartmouth PMS 350
- OG Blue PMS 2768
- UN Blue PMS 279
- Emerald 3425
- OG Red PMS 187
- White
- FM Yellow PMS 106
- Orange PMS 172

PMS colors are for reference only and may vary slightly from actual color.

Solid-Color Flag

Item #	Description	Product Wt.	1
304516	2' x 3'	1 lb.	21.39
304517	3' x 5'	1 lb.	32.72
304518	4' x 6'	1.25 lbs.	50.34
304519	5' x 8'	1.5 lbs.	75.50

USD MSRP (C)

AFTER FINAL PROOF APPROVAL
PRODUCTION LEAD TIME IS
4DAYS

Prices are subject to change; visit our website for the most current pricing. See pages 208-211 for additional information that may apply to your order.

Suggested Uses

- Sporting Events
- Rallies
- Festivals
- Trade Shows



SPIRIT FLAG

The Spirit Flag is a great way to energize the crowd.

- Single-sided and double-sided options available
- Artwork is printed on 200 denier nylon
- 3" pole sleeve is closed at the top to prevent the flag from sliding down the pole
- Flags used outdoors have a 90-day warranty; flags used indoors have a 1-year warranty



Spirit Flag

Item #	Description	Product Wt.	1	2-5	6-11	12-24
304650	3' x 5' Single-Sided Kit	1.45 lbs.	144.80	133.20	124.50	115.80
304651	3' x 5' Double-Sided Kit	2.35 lbs.	237.80	218.80	204.50	190.20
304654	4' x 6' Single-Sided Kit	1.7 lbs.	174.90	160.90	150.40	139.90
304655	4' x 6' Double-Sided Kit	3.1 lbs.	297.00	273.25	255.50	237.50
304658	5' x 8' Single-Sided Kit	2 lbs.	231.50	213.00	199.10	185.20
304659	5' x 8' Double-Sided Kit	4 lbs.	409.00	376.25	351.75	327.25
304662	6' x 10' Single-Sided Kit	4 lbs.	343.50	316.00	295.50	274.75
304663	6' x 10' Double-Sided Kit	5.6 lbs.	604.00	555.50	519.50	483.00
304666	8' x 12' Single-Sided Kit	7 lbs.	598.00	550.00	514.50	478.50
304667	8' x 12' Double-Sided Kit	12.7 lbs.	1101.00	1013.00	947.00	881.00

Kit Includes: Pole Hardware and Graphic

USD MSRP (C)



The bottom of the sleeve features a leather tab that can be zip-tied to the pole.

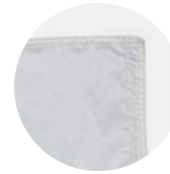

Double-needle hem on the top and bottom; four rows of stitching on the fly end.

INSTA-FLAG POLE

Instantly display a flag at your next outdoor event with this quick and easy flagpole.

- Great for temporary pop-up events
- Kit contains two clips to attach a grommeted flag to the pole
- Compatible with flags up to 3' x 5' (flag sold separately)
- Available in 10', 15' and 18' poles with a spike or vehicle base option
- Insta-Flag Pole can be used on most other sail sign bases depending on your needs (sold separately)



Included clips attach to the pole to display a flag.



Carbon composite overlay construction with high-gloss black paint finish.

Insta-Flag Pole

Item #	Description	1	2-5	6-11	12-24
190630	10' with Ground Spike Kit	149.80	144.30	138.70	132.40
190631	10' with Vehicle Base Kit	178.20	171.90	164.90	157.70
190632	15' with Ground Spike Kit	162.30	156.40	150.40	143.40
190633	15' with Vehicle Base Kit	190.80	184.00	176.60	168.70
190634	18' with Ground Spike Kit	175.00	168.50	162.20	154.60
190635	18' with Vehicle Base Kit	203.40	196.10	188.40	179.90

Kit Includes: Hardware, 2 Flag Hooks, Ground or Vehicle Base and Soft Carry Case (Flag Sold Separately)

USD MSRP (C)



Prices are subject to change; visit our website for the most current pricing.
Setup fee: \$20.00(G).
See pages 208-211 for additional information that may apply to your order.

SPIRIT AFTER FINAL PROOF APPROVAL PRODUCTION LEAD TIME IS 4 DAYS SHIPS SAME DAY WHEN ORDERED BEFORE 2 PM CENTRAL

Suggested Uses
 Sporting Events
 Rallies
 Festivals
 Trade Shows



Double-sided flags feature a lightweight block-out polyester for increased flyability.



FABRIC FLAG

Easy to hang, this flag works with any standard flagpole.

- Best for outdoor use
- Single- and double-sided options available
- Artwork is dye sublimated on super poly knit fabric for single-sided flags and on block-out polyester for double-sided flags
- Custom sizes and finishing available (visit website or call for quote; restrictions may apply)
- Flags used outdoors have a 90-day warranty; flags used indoors have a 1-year warranty



Rectangle Fabric Flag (Single-Sided)

Item #	Description	Product Wt.	1	2-5	6-11	12-24
191900	8" x 12"	0.04 lb.	45.30	36.24	33.98	29.45
191901	12" x 18"	0.06 lb.	50.35	40.30	37.75	32.75
191902	16" x 24"	0.12 lb.	55.40	44.30	41.55	36.00
300003	2' x 3'	0.25 lb.	62.90	50.30	47.20	40.90
191903	2.5' x 4'	0.25 lb.	88.10	70.50	66.10	57.25
300007	3' x 5'	0.5 lb.	100.70	80.60	75.50	65.50
300011	4' x 6'	1 lb.	138.40	110.70	103.80	90.00
300015	5' x 8'	1.25 lbs.	186.30	149.00	139.70	121.10
300071	6' x 10'	1.5 lbs.	289.50	231.50	217.25	188.25
191904	8' x 12'	5 lbs.	491.00	392.75	368.25	319.25
191905	10' x 15'	6 lbs.	818.00	654.50	613.50	531.50

USD MSRP (C)

Rectangle Fabric Flag (Double-Sided)

Item #	Description	Product Wt.	1	2-5	6-11	12-24
191906	8" x 12"	0.08 lb.	90.60	72.50	67.95	58.90
191907	12" x 18"	0.12 lb.	100.70	80.60	75.50	65.50
191908	16" x 24"	0.24 lb.	110.80	88.60	83.10	72.00
300018	2' x 3'	0.5 lb.	125.80	100.60	94.40	81.80
191909	2.5' x 4'	0.5 lb.	176.20	141.00	132.20	114.50
300019	3' x 5'	1 lb.	201.30	161.00	151.00	130.80
300020	4' x 6'	2 lbs.	277.00	221.50	207.75	180.00
300021	5' x 8'	2.5 lbs.	372.50	298.00	279.50	242.25
300072	6' x 10'	3 lbs.	579.00	463.00	434.50	376.50

USD MSRP (C)

Single-Sided



Single-sided flags are printed on one side; reverse image shows through the back.

Double-Sided



Double-sided flags have the image printed correctly on both sides with a block-out polyester.

AFTER FINAL PROOF APPROVAL
 PRODUCTION LEAD TIME IS
4 DAYS

Prices are subject to change; visit our website for the most current pricing.
 Setup fee: \$20.00(G).
 See pages 208-211 for additional information that may apply to your order.

Pennant Fabric Flag (Single-Sided)

Item #	Description	Product Wt.	1	2-5	6-11	12-24
191910	8" x 12"	0.04 lb.	45.30	36.24	33.98	29.45
191911	12" x 18"	0.06 lb.	50.35	40.30	37.75	32.75
191912	16" x 24"	0.12 lb.	55.40	44.30	41.55	36.00
191913	2' x 3'	0.25 lb.	62.90	50.30	47.20	40.90
191914	2.5' x 4'	0.25 lb.	88.10	70.50	66.10	57.25
191915	3' x 5'	0.5 lb.	100.70	80.60	75.50	65.50
191916	4' x 6'	1 lb.	138.40	110.70	103.80	90.00
191917	5' x 8'	1.25 lbs.	201.30	161.00	151.00	130.80
191918	6' x 10'	1.5 lbs.	289.50	231.50	217.25	188.25

USD MSRP (C)

Pennant Fabric Flag (Double-Sided)

Item #	Description	Product Wt.	1	2-5	6-11	12-24
191919	8" x 12"	0.08 lb.	90.60	72.50	67.95	58.90
191920	12" x 18"	0.12 lb.	100.70	80.60	75.50	65.50
191921	16" x 24"	0.24 lb.	110.80	88.60	83.10	72.00
191922	2' x 3'	0.5 lb.	125.80	100.60	94.40	81.80
191923	2.5' x 4'	0.5 lb.	176.20	141.00	132.20	114.50
191924	3' x 5'	1 lb.	201.30	161.00	151.00	130.80
191925	4' x 6'	2 lbs.	277.00	221.50	207.75	180.00
191926	5' x 8'	2.5 lbs.	402.75	322.25	302.00	261.75
191927	6' x 10'	3 lbs.	579.00	463.00	434.50	376.50

USD MSRP (C)

Guidon Fabric Flag (Single-Sided)

Item #	Description	Product Wt.	1	2-5	6-11	12-24
191928	8" x 12"	0.04 lb.	45.30	36.24	33.98	29.45
191929	12" x 18"	0.06 lb.	50.35	40.30	37.75	32.75
191930	16" x 24"	0.12 lb.	55.40	44.30	41.55	36.00
191931	20" x 27.75"	0.2 lb.	60.40	48.30	45.30	39.25
191932	2' x 3'	0.25 lb.	62.90	50.30	47.20	40.90
191933	2.5' x 4'	0.25 lb.	88.10	70.50	66.10	57.25
191934	3' x 5'	0.5 lb.	100.70	80.60	75.50	65.50
191935	4' x 6'	1 lb.	138.40	110.70	103.80	90.00
191936	5' x 8'	1.25 lbs.	201.30	161.00	151.00	130.80
191937	6' x 10'	1.5 lbs.	289.50	231.50	217.25	188.25

USD MSRP (C)

Guidon Fabric Flag (Double-Sided)

Item #	Description	Product Wt.	1	2-5	6-11	12-24
191938	8" x 12"	0.08 lb.	90.60	72.50	67.95	58.90
191939	12" x 18"	0.12 lb.	100.70	80.60	75.50	65.50
191940	16" x 24"	0.24 lb.	110.80	88.60	83.10	72.00
191941	20" x 27.75"	0.4 lb.	120.80	96.60	90.60	78.50
191942	2' x 3'	0.5 lb.	125.80	100.60	94.40	81.80
191943	2.5' x 4'	0.5 lb.	176.20	141.00	132.20	114.50
191944	3' x 5'	1 lb.	201.30	161.00	151.00	130.80
191945	4' x 6'	2 lbs.	277.00	221.50	207.75	180.00
191946	5' x 8'	2.5 lbs.	402.75	322.25	302.00	261.75
191947	6' x 10'	3 lbs.	579.00	463.00	434.50	376.50

USD MSRP (C)

Burgee Fabric Flag (Single-Sided)

Item #	Description	Product Wt.	1	2-5	6-11	12-24
191948	8" x 12"	0.04 lb.	45.30	36.24	33.98	29.45
191949	12" x 18"	0.06 lb.	50.35	40.30	37.75	32.75
191950	16" x 24"	0.12 lb.	55.40	44.30	41.55	36.00
191951	2' x 3'	0.25 lb.	62.90	50.30	47.20	40.90
191952	2.5' x 4'	0.25 lb.	88.10	70.50	66.10	57.25
191953	3' x 5'	0.5 lb.	100.70	80.60	75.50	65.50
191954	4' x 6'	1 lb.	138.40	110.70	103.80	90.00
191955	5' x 8'	1.25 lbs.	201.30	161.00	151.00	130.80
191956	6' x 10'	1.5 lbs.	289.50	231.50	217.25	188.25

USD MSRP (C)

Burgee Fabric Flag (Double-Sided)

Item #	Description	Product Wt.	1	2-5	6-11	12-24
191957	8" x 12"	0.08 lb.	90.60	72.50	67.95	58.90
191958	12" x 18"	0.12 lb.	100.70	80.60	75.50	65.50
191959	16" x 24"	0.24 lb.	110.80	88.60	83.10	72.00
191960	2' x 3'	0.5 lb.	125.80	100.60	94.40	81.80
191961	2.5' x 4'	0.5 lb.	176.20	141.00	132.20	114.50
191962	3' x 5'	1 lb.	201.30	161.00	151.00	130.80
191963	4' x 6'	2 lbs.	277.00	221.50	207.75	180.00
191964	5' x 8'	2.5 lbs.	402.75	322.25	302.00	261.75
191965	6' x 10'	3 lbs.	579.00	463.00	434.50	376.50

USD MSRP (C)



Pennant: Most often used for identifying athletic teams



Guidon: Commonly used for promoting military units



Burgee: Traditionally used for signaling and identifying watercraft

Prices are subject to change; visit our website for the most current pricing.
 Setup fee: \$20.00(G).
 See pages 208-211 for additional information that may apply to your order.

AFTER FINAL PROOF APPROVAL
 PRODUCTION LEAD TIME IS
4 DAYS



GOLF FLAG

This golf flag will give your course or event a personalized touch.

- Artwork is printed on 200 denier nylon
- Single-sided flags show artwork on one side with the reverse image visible through the back
- Double-sided flags feature two layers sewn together with a block-out liner in between
- Flags used outdoors have a 90-day warranty;
- flags used indoors have a 1-year warranty



Golf Flag

Item #	Description	Product Wt.	1	2-5	6-11	12-24
304620	20" x 14" Canvas Header Flag Single-Sided	0.25 lb.	65.40	52.30	49.05	42.50
304621	20" x 14" Tube Flag Single-Sided	1 lb.	75.50	60.40	56.65	49.10
304622	20" x 14" Canvas Header Flag Double-Sided	1 lb.	130.80	104.60	98.10	85.00
304623	20" x 14" Tube Flag Double-Sided	1.75 lbs.	151.00	120.80	113.30	98.20

USD MSRP (C)



Available with canvas header and grommets or sewn-in golf tube.



Canvas header flag



Tube flag



Suggested Uses

- Tournaments
- Fundraisers
- Company Events
- Golf Courses

CAR FLAG

Car flags are a great way to get attention while on the road.

- Can be used on cars in motion (45 mph maximum speed)
- Artwork is dye sublimated on super poly knit fabric for single-sided flags and on block-out polyester for double-sided flags
- 1.5" pole sleeve is closed at the top to prevent the flag from sliding down the pole
- The bottom of the sleeve features a leather tab that is zip-tied to the pole
- The Car Flag premium pole is constructed of high gauge plastic
- 30-day warranty on flag



Car Flag

Item #	Description	Product Wt.	1	2-5	6-11	12-24
304690	18" x 12" Single-Sided Kit	0.5 lb.	73.00	67.15	62.80	58.40
304691	18" x 12" Double-Sided Kit	1 lb.	146.00	134.30	125.60	116.80

Kit Includes: Pole and Installed Graphic USD MSRP (C)

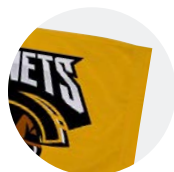

Double-sided flags feature a lightweight block-out polyester for increased flyability.

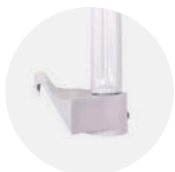

To install, simply place the flagpole's clip on your window and roll up the window.

AFTER FINAL PROOF APPROVAL
PRODUCTION LEAD TIME IS
4 DAYS

Prices are subject to change; visit our website for the most current pricing.
Setup fee: \$20.00(G).
See pages 208-211 for additional information that may apply to your order.

STICK FLAG

These mini flags are great on desktops or as mementos.

- Perfect for parades and interactive events
- Available with a black staff and gold spear tip; 4" x 6" staff is hollow
- Flag is single-sided; finished with clean-cut edges and a pole sleeve
- Artwork is printed on 100 denier polyester
- Flags used outdoors have a 90-day warranty; flags used indoors have a 1-year warranty
- High volume opportunities available (call for quote; restrictions may apply)
- Not eligible for Rush Service



Stick Flag

Item #	Description	Product Wt.	1	2-5	6-11	12-24
304640	4" x 6" (Set of 6)	0.9 lb.	90.60	72.50	67.95	58.90
304641	6" x 9" (Set of 6)	1.2 lbs.	105.80	84.60	79.40	68.80
304642	8" x 12" (Set of 6)	1.8 lbs.	151.00	120.80	113.30	98.20
304643	12" x 18" (Set of 6)	2.1 lbs.	181.20	145.00	135.90	117.80
304644	16" x 24" (Set of 6)	2.7 lbs.	196.40	157.10	147.30	127.70

USD MSRP (C)



6" x 9"

4" x 6"

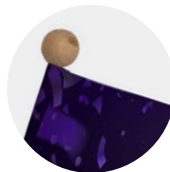

Stick Flags with gold ball tip and natural wood color staff are also available; see website.



Stick Flag Base available with 1, 2 or 3 holes (sold separately; see page 159). Base fits 4" x 6" Stick Flag only.



PENNANT STRING

Dress up your balconies, decks, windows, and parade floats with these festive pennants.

- Single-sided pennants are printed on Titan™ 13 oz. scrim vinyl; double-sided pennants are printed on Titan™ 18 oz. opaque scrim vinyl
- Pennants are 9" x 12"; 20' strings feature 11 pennants, 30' strings feature 16 pennants
- Custom pennant strings available (call for quote; restrictions may apply)
- Pennants used outdoors have a 90-day warranty; pennants used indoors have a 1-year warranty



Pennant String

Item #	Description	Product Wt.	1	2-5	6-11	12-24
304770	20' Single-Sided	0.6 lb.	114.50	105.30	98.50	91.60
304771	30' Single-Sided	0.8 lb.	167.30	153.90	143.90	133.80
304772	20' Double-Sided	0.8 lb.	183.80	169.10	158.10	147.00
304773	30' Double-Sided	1 lb.	268.00	246.50	230.50	214.50

USD MSRP (C)



Ropes are available in white only.



Prices are subject to change; visit our website for the most current pricing.
Setup fee: \$20.00(G).
See pages 208-211 for additional information that may apply to your order.

STICK PENNANT STRING
AFTER FINAL PROOF APPROVAL
PRODUCTION LEAD TIME IS
74 DAYS
OR







HIGH-IMPACT FLAGS THAT FLUTTER IN THE WIND

SAIL SIGN COMPARISON CHART

BEST SELLERS ★	AVAILABLE SHAPES AND SIZES				MATERIAL	FEATURES	WIND RATING	
	GOOD	PG #	BLADE	RAZOR				TEARDROP
Value ★ 80		7.5'	7.5'	6.5'	Super Poly Knit Block-out Polyester	<ul style="list-style-type: none"> • value hardware • value spike or value cross base • plastic-capped ends on cross base • double-layer reinforcement at the end of the pole pocket for additional strength • pole pocket is made of the same fabric as the flag 	62	
		10.5'	10.5'	9.5'				
		15'	15'	13'				
BETTER	PG #							
Streamline ★ 82		7'	7'	6'	Super Poly Knit Block-out Polyester	<ul style="list-style-type: none"> • premium hardware • ground spike, scissor base or three-legged base • rubber-tipped ends on scissor base • double-layer reinforcement at the end of the pole pocket for additional strength • pole pocket is made of the same fabric as the flag 	62	
		9'	9'	8'				10'
		13'	13'	11.5'				14.5'
		17'	17'	15'				
BEST	PG #							
Premium ★ 84		7'	7'	6'	Super Poly Knit Block-out Polyester	<ul style="list-style-type: none"> • premium hardware • ground spike, scissor base or three-legged base • rubber-tipped ends on scissor base • double-layer reinforcement at the end of the pole pocket for additional strength • reinforced with premium elastic black pole sleeve 	62	
		9'	9'	8'				10'
		13'	13'	11.5'				14.5'
		17'	17'	15'				
Elite 86		7'	7'	6'	200 Denier Nylon	<ul style="list-style-type: none"> • premium hardware • ground spike, scissor base or three-legged base • rubber-tipped ends on scissor base • double-layer reinforcement at the end of the pole pocket for additional strength • reinforced with premium elastic black pole sleeve 	62	
		9'	9'	8'				
		13'	13'	11.5'				
		17'	17'	15'				

 **Beaufort Wind Rating:** Select products have been rated on the Beaufort Wind Scale. See rating icon underneath the product name. Wind ratings were determined utilizing all available securing/stabilizing options sold with or offered for the product. Review the Beaufort Scale on page 211 for additional details.

HARDWARE COMPARISON CHART

	POLE CONSTRUCTION	FLAG ATTACHMENT	CARRY CASE	HARDWARE WARRANTY
Value Hardware	 <p>Channeled carbon composite overlay construction with low-gloss black paint finish.</p> <p>Double-reinforced carbon fiber pole segment ends.</p>	 <p>A loop on the flag attaches to an adjustable hook on the pole.</p>	Sold separately (see page 85)	
Premium, Streamline and Elite Hardware	 <p>Uniform carbon composite overlay construction with high-gloss black paint finish.</p> <p>Polished aluminum collar pole segment ends and ergonomic, rubber-reinforced base grip.</p>	 <p>Flag attaches to a fixed hook using a bungee cord.</p>		

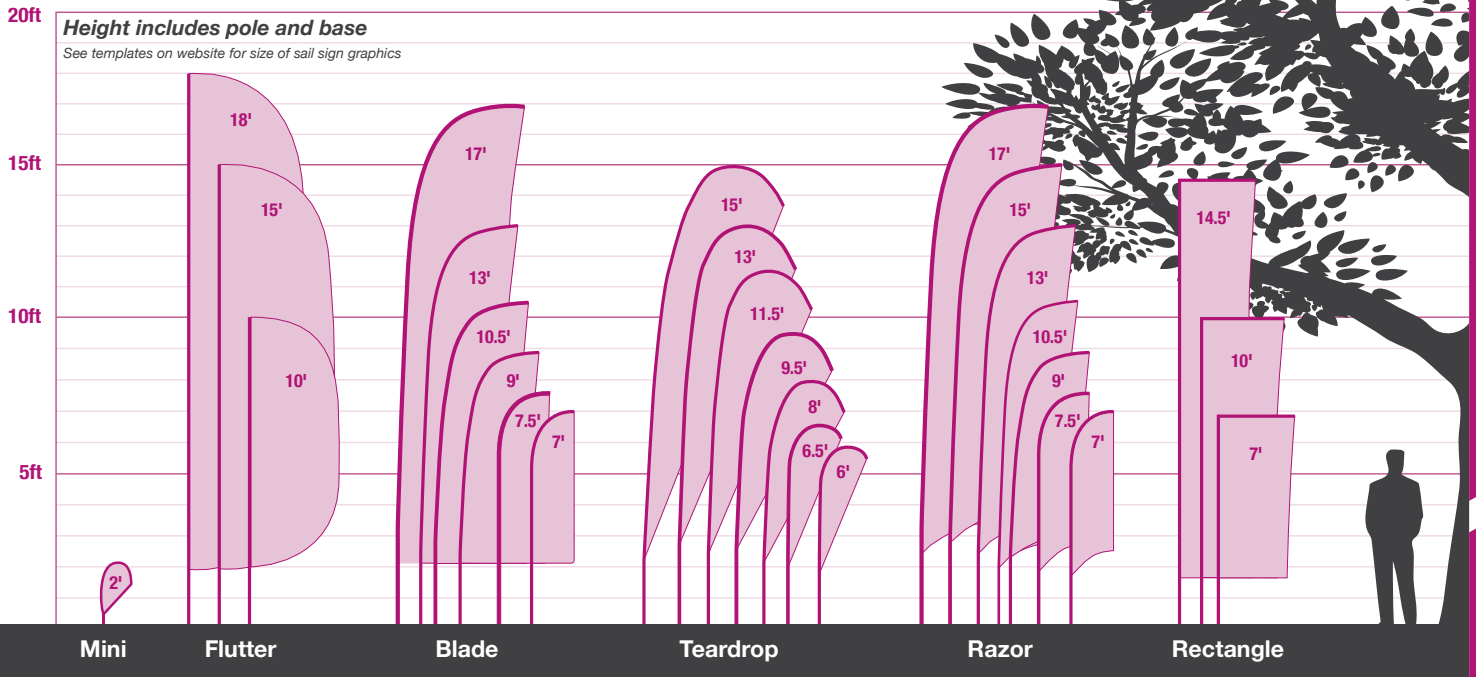

Disclaimer:
 Wind rating conducted in a controlled environment. Outdoor products should be taken down if bad weather is likely. Wind gusts and heavy rain may reduce the wind resistance of these products.

MAXIMIZE THE IMPACT OF YOUR MESSAGE



Single-Sided

Image printed on one side; reverse image shows through back.



Double-Sided

Image printed correct on both sides using a block-out polyester. (excludes Elite sail signs)

CUSTOMIZE WITH BASE OPTIONS

Kits include spike, cross base with water ballast, or scissor base with water ballast.

Select double-sided spike kits include the Ground Anchor spike. We also carry several other bases designed to work on various types of terrain; see page 94.



VALUE SAIL SIGN

Value sail signs are a high quality budget-minded sail flag solution - perfect for indoor and short-term outdoor use.

- Three classic shapes
- Value spike for outdoor use or value cross base for indoor/outdoor use
- Carbon composite poles are strong and flexible
- Artwork is dye sublimated on super poly knit fabric for single-sided sail signs and on block-out polyester for double-sided sail signs
- 90-day warranty on hardware and flag
- Can be stored and transported in our Value sail sign soft carry case (sold separately)



Suggested Uses

- Restaurants
- Salons
- Auto Body Shops
- Sporting Events



13' and 15' double-sided spike kits include the Ground Anchor spike; attach to Value spike for additional stability.



Double-sided flags feature a lightweight block-out polyester for increased flyability.



7.5' Blade 10.5' Razor 15' Razor 13' Teardrop 10.5' Blade 6.5' Teardrop

Single- or Double-Sided



Single-Sided

Image printed on one side; reverse image shows through back.



Double-Sided

Image printed correctly on both sides using a block-out polyester.

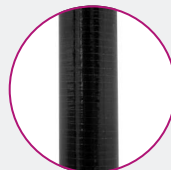

Channeled carbon composite overlay construction with low-gloss black paint finish.

Durable Construction

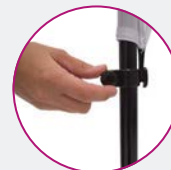

A loop on the flag attaches to an adjustable hook on the pole.

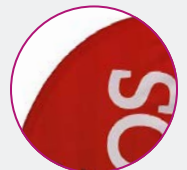

Pole pocket is made of the same fabric as the flag.



Value Blade Sail Sign

Description	Item #	Single-Sided Flag				Double-Sided Flag				
		1	2-5	6-11	12-24	Item #	1	2-5	6-11	12-24
7.5' Kit with Value Spike	191730	156.40	151.70	143.90	139.20	191732	246.90	239.50	227.20	219.70
7.5' Kit with Cross Base and Water Ballast	191731	190.10	184.40	174.90	169.20	191733	286.50	278.00	263.75	255.00
10.5' Kit with Value Spike	191736	185.50	180.00	170.70	165.10	191738	291.25	282.50	268.00	259.25
10.5' Kit with Cross Base and Water Ballast	191737	216.30	209.80	198.90	192.50	191739	328.75	319.00	302.50	292.75
15' Kit with Value Spike	191742	245.30	237.90	225.60	218.30	191744	397.50	385.50	365.50	353.75
15' Kit with Cross Base and Water Ballast	191743	285.00	276.50	262.25	253.75	191745	429.75	416.75	395.25	382.50

Kit Includes: Hardware with Specified Base and Graphic (Does not include carry case)

USD MSRP (C)

Description	Product Size w/Spike	Product Size w/Cross Base	Finished Graphic Size	Product Wt. (Spike / Cross)	Media (Single- / Double-Sided)
7.5'	28.5"W x 88.25"H x 1.5"D	43.5"W x 91.625"H x 23.75"D	View Online Template	3 lbs. / 4.3 lbs.	Super Poly Knit Fabric / Block-Out Polyester
10.5'	30.25"W x 124"H x 1.5"D	45.25"W x 127.375"H x 23.75"D	View Online Template	3.8 lbs. / 5.1 lbs.	Super Poly Knit Fabric / Block-Out Polyester
15'	35.5"W x 177"H x 1.5"D	50.5"W x 180.375"H x 23.75"D	View Online Template	5.6 lbs. / 6.3 lbs.	Super Poly Knit Fabric / Block-Out Polyester



Value Razor Sail Sign

Description	Item #	Single-Sided Flag				Double-Sided Flag				
		1	2-5	6-11	12-24	Item #	1	2-5	6-11	12-24
7.5' Kit with Value Spike	191650	156.40	151.70	143.90	139.20	191652	246.70	239.30	227.00	219.60
7.5' Kit with Cross Base and Water Ballast	191651	190.10	184.40	174.90	169.20	191653	286.50	277.75	263.50	255.00
10.5' Kit with Value Spike	191658	185.50	180.00	170.70	165.10	191660	291.25	282.50	268.00	259.25
10.5' Kit with Cross Base and Water Ballast	191659	216.30	209.80	198.90	192.50	191661	328.75	319.00	302.50	292.75
15' Kit with Value Spike	191666	245.30	237.90	225.60	218.30	191668	397.50	385.50	365.50	353.75
15' Kit with Cross Base and Water Ballast	191667	285.00	276.50	262.25	253.75	191669	429.75	416.75	395.25	382.50

Kit Includes: Hardware with Specified Base and Graphic (Does not include carry case)

USD MSRP (C)

Description	Product Size w/Spike	Product Size w/Cross Base	Finished Graphic Size	Product Wt. (Spike / Cross)	Media (Single- / Double-Sided)
7.5'	28.5"W x 88.25"H x 1.5"D	43.5"W x 91.625"H x 23.75"D	View Online Template	3 lbs. / 4.3 lbs.	Super Poly Knit Fabric / Block-Out Polyester
10.5'	30.25"W x 124"H x 1.5"D	45.25"W x 127.375"H x 23.75"D	View Online Template	3.8 lbs. / 5.1 lbs.	Super Poly Knit Fabric / Block-Out Polyester
15'	35.5"W x 177"H x 1.5"D	50.5"W x 180.375"H x 23.75"D	View Online Template	5.6 lbs. / 6.3 lbs.	Super Poly Knit Fabric / Block-Out Polyester



Value Teardrop Sail Sign

Description	Item #	Single-Sided Flag				Double-Sided Flag				
		1	2-5	6-11	12-24	Item #	1	2-5	6-11	12-24
6.5' Kit with Value Spike	191610	156.40	151.70	143.90	139.20	191612	246.70	239.30	227.00	219.60
6.5' Kit with Cross Base and Water Ballast	191611	190.10	184.40	174.90	169.20	191613	286.50	277.75	263.50	255.00
9.5' Kit with Value Spike	191618	185.50	180.00	170.70	165.10	191620	291.25	282.50	268.00	259.25
9.5' Kit with Cross Base and Water Ballast	191619	216.30	209.80	198.90	192.50	191621	328.75	319.00	302.50	292.75
13' Kit with Value Spike	191626	245.30	237.90	225.60	218.30	191628	397.50	385.50	365.50	353.75
13' Kit with Cross Base and Water Ballast	191627	285.00	276.50	262.25	253.75	191629	429.75	416.75	395.25	382.50

Kit Includes: Hardware with Specified Base and Graphic (Does not include carry case)

USD MSRP (C)

Description	Product Size w/Spike	Product Size w/Cross Base	Finished Graphic Size	Product Wt. (Spike / Cross)	Media (Single- / Double-Sided)
6.5'	34.25"W x 78.5"H x 1.5"D	49.25"W x 81.875"H x 23.75"D	View Online Template	2.8 lbs. / 4.1 lbs.	Super Poly Knit Fabric / Block-Out Polyester
9.5'	44.25"W x 112.5"H x 1.5"D	59.25"W x 115.875"H x 23.75"D	View Online Template	3.4 lbs. / 4.7 lbs.	Super Poly Knit Fabric / Block-Out Polyester
13'	51.5"W x 154"H x 1.5"D	66.5"W x 157.375"H x 23.75"D	View Online Template	5 lbs. / 5.7 lbs.	Super Poly Knit Fabric / Block-Out Polyester



Value Sail Sign Bases and Optional Carry Case

Item #	Description	Product Wt.	1	2-5	6-11	12-24
191590	Value Spike	2 lbs.	39.77	38.58	36.59	35.40
191591	Value Cross Base	2.8 lbs.	39.77	38.58	36.59	35.40
220351	Value Sail Sign Soft Carry Case	0.8 lb.	21.40	20.97	20.33	19.90

USD MSRP (C)



Add-Ons

HARDWARE-ONLY LEAD TIME: SHIPS SAME DAY WHEN ORDERED BEFORE 2 PM CENTRAL

Prices are subject to change; visit our website for the most current pricing.
Setup fee: \$20.00(G).
See pages 208-211 for additional information that may apply to your order.

AFTER FINAL PROOF APPROVAL
PRODUCTION LEAD TIME IS
4 DAYS

STREAMLINE SAIL SIGN

Streamline sail signs provide the largest artwork surface area with its integrated printed pole pocket.

- Sizes range from 6' to 17' tall
- Carbon composite poles are strong and flexible
- Artwork is dye sublimated on super poly knit fabric for single-sided sail signs and on block-out polyester for double-sided sail signs
- Flags used outdoors have a 90-day warranty; flags used indoors have a 1-year warranty
- Lifetime warranty on pole hardware



Suggested Uses
Retail Promotions
Shopping Malls
Libraries
Town Halls



14.5', 15' and 17' double-sided spike kits include the Ground Anchor spike; attach to Ground spike for additional stability.



Double-sided flags feature a lightweight block-out polyester for increased flyability.



7' Blade 10' Rectangle 13' Razor 15' Teardrop 14.5' Rectangle 13' Blade 9' Razor 6' Teardrop

Single- or Double-Sided



Single-Sided

Image printed on one side; reverse image shows through back.



Double-Sided

Image printed correctly on both sides using a block-out polyester.



Uniform carbon composite overlay construction with high-gloss black paint finish.

Durable Construction

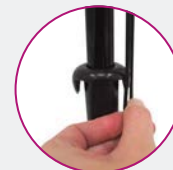

Flag attaches to a fixed hook using a bungee cord.



Pole pocket is made of the same fabric as the flag.



Streamline Blade Sail Sign

Single-Sided Flag

Double-Sided Flag

Description	Item #	1	2-5	6-11	12-24	Item #	1	2-5	6-11	12-24
7' Kit with Ground Spike	191490	226.20	219.30	208.00	201.30	191492	327.75	318.00	301.50	291.75
7' Kit with Three-Legged Base and Water Ballast	191491	267.00	259.00	245.50	237.75	191493	368.75	357.75	339.25	328.25
9' Kit with Ground Spike	191496	254.50	247.00	234.25	226.50	191498	372.25	361.00	342.50	331.25
9' Kit with Scissor Base and Water Ballast	191497	337.75	327.50	310.75	300.75	191499	455.25	441.50	419.00	405.25
13' Kit with Ground Spike	191502	314.75	305.25	289.50	280.25	191504	482.25	467.75	443.75	429.25
13' Kit with Scissor Base and Water Ballast	191503	398.00	386.00	366.00	354.25	191505	565.50	548.50	520.00	503.50
17' Kit with Ground Spike	191508	387.00	375.50	356.00	344.50	191510	599.00	581.00	551.00	533.00
17' Kit with Scissor Base and Water Ballast	191509	470.25	456.00	432.75	418.50	191511	682.00	661.50	627.50	607.00

Kit Includes: Hardware with Specified Base, Graphic and Soft Carry Case

USD MSRP (C)

Description	Product Size w/Ground Spike	Product Size w/Scissor Base	Finished Graphic Size	Product Wt. (Spike / Scissor)	Media (Single- / Double-Sided)
7'	19.75"W x 81.5"H x 2"D	28.375"W x 83.5"H x 15.25"D	View Online Template	3 lbs. / 2.75 lbs.	Super Poly Knit Fabric / Block-Out Polyester
9'	29"W x 106"H x 2"D	40.5"W x 108"H x 23"D	View Online Template	4.75 lbs. / 10.25 lbs.	Super Poly Knit Fabric / Block-Out Polyester
13'	32"W x 151"H x 2"D	43.5"W x 153"H x 23"D	View Online Template	6.75 lbs. / 10.75 lbs.	Super Poly Knit Fabric / Block-Out Polyester
17'	36"W x 205"H x 2"D	47.5"W x 207"H x 23"D	View Online Template	9.4 lbs. / 14.25 lbs.	Super Poly Knit Fabric / Block-Out Polyester



Streamline Razor Sail Sign

Single-Sided Flag

Double-Sided Flag

Description	Item #	1	2-5	6-11	12-24	Item #	1	2-5	6-11	12-24
7' Kit with Ground Spike	191428	226.20	219.30	208.00	201.30	191436	327.75	318.00	301.50	291.75
7' Kit with Three-Legged Base and Water Ballast	191429	267.00	259.00	245.50	237.75	191437	368.75	357.75	339.25	328.25
9' Kit with Ground Spike	191430	254.50	247.00	234.25	226.50	191438	372.25	361.00	342.50	331.25
9' Kit with Scissor Base and Water Ballast	191431	337.75	327.50	310.75	300.75	191439	455.25	441.50	419.00	405.25
13' Kit with Ground Spike	191432	314.75	305.25	289.50	280.25	191440	482.25	467.75	443.75	429.25
13' Kit with Scissor Base and Water Ballast	191433	398.00	386.00	366.00	354.25	191441	565.50	548.50	520.00	503.50
17' Kit with Ground Spike	191434	387.00	375.50	356.00	344.50	191442	599.00	581.00	551.00	533.00
17' Kit with Scissor Base and Water Ballast	191435	470.25	456.00	432.75	418.50	191443	682.00	661.50	627.50	607.00

Kit Includes: Hardware with Specified Base, Graphic and Soft Carry Case

USD MSRP (C)

Description	Product Size w/Ground Spike	Product Size w/Scissor Base	Finished Graphic Size	Product Wt. (Spike / Scissor)	Media (Single- / Double-Sided)
7'	19.75"W x 81.5"H x 2"D	28.375"W x 83.5"H x 15.25"D	View Online Template	3 lbs. / 2.75 lbs.	Super Poly Knit Fabric / Block-Out Polyester
9'	29"W x 106"H x 2"D	40.5"W x 108"H x 23"D	View Online Template	4.75 lbs. / 10.25 lbs.	Super Poly Knit Fabric / Block-Out Polyester
13'	32"W x 151"H x 2"D	43.5"W x 153"H x 23"D	View Online Template	6.75 lbs. / 10.75 lbs.	Super Poly Knit Fabric / Block-Out Polyester
17'	36"W x 205"H x 2"D	47.5"W x 207"H x 23"D	View Online Template	9.4 lbs. / 14.25 lbs.	Super Poly Knit Fabric / Block-Out Polyester



Streamline Teardrop Sail Sign

Single-Sided Flag

Double-Sided Flag

Description	Item #	1	2-5	6-11	12-24	Item #	1	2-5	6-11	12-24
6' Kit with Ground Spike	191400	226.20	219.30	208.00	201.30	191408	327.75	318.00	301.50	291.75
6' Kit with Three-Legged Base and Water Ballast	191401	267.00	259.00	245.50	237.75	191409	368.75	357.75	339.25	328.25
8' Kit with Ground Spike	191402	254.50	247.00	234.25	226.50	191410	372.25	361.00	342.50	331.25
8' Kit with Scissor Base and Water Ballast	191403	337.75	327.50	310.75	300.75	191411	455.25	441.50	419.00	405.25
11.5' Kit with Ground Spike	191404	314.75	305.25	289.50	280.25	191412	482.25	467.75	443.75	429.25
11.5' Kit with Scissor Base and Water Ballast	191405	398.00	386.00	366.00	354.25	191413	565.50	548.50	520.00	503.50
15' Kit with Ground Spike	191406	387.00	375.50	356.00	344.50	191414	599.00	581.00	551.00	533.00
15' Kit with Scissor Base and Water Ballast	191407	470.25	456.00	432.75	418.50	191415	682.00	661.50	627.50	607.00

Kit Includes: Hardware with Specified Base, Graphic and Soft Carry Case

USD MSRP (C)

Description	Product Size w/Ground Spike	Product Size w/Scissor Base	Finished Graphic Size	Product Wt. (Spike / Scissor)	Media (Single- / Double-Sided)
6'	23.25"W x 72.5"H x 2"D	31.875"W x 74.5"H x 15.25"D	View Online Template	2.75 lbs. / 2.5 lbs.	Super Poly Knit Fabric / Block-Out Polyester
8'	30.5"W x 91.5"H x 2"D	42"W x 93.5"H x 22.75"D	View Online Template	4.75 lbs. / 10.25 lbs.	Super Poly Knit Fabric / Block-Out Polyester
11.5'	36"W x 144.5"H x 2"D	47.5"W x 146.5"H x 22.75"D	View Online Template	7.25 lbs. / 12.75 lbs.	Super Poly Knit Fabric / Block-Out Polyester
15'	40"W x 194.5"H x 2"D	51.5"W x 196.5"H x 22.75"D	View Online Template	10.4 lbs. / 15.25 lbs.	Super Poly Knit Fabric / Block-Out Polyester



Streamline Rectangle Sail Sign

Single-Sided Flag

Double-Sided Flag

Description	Item #	1	2-5	6-11	12-24	Item #	1	2-5	6-11	12-24
7' Kit with Ground Spike	191416	254.50	247.00	234.25	226.50	191422	372.25	361.00	342.50	331.25
7' Kit with Scissor Base and Water Ballast	191417	337.75	327.50	310.75	300.75	191423	455.25	441.50	419.00	405.25
10' Kit with Ground Spike	191418	314.75	305.25	289.50	280.25	191424	482.25	467.75	443.75	429.25
10' Kit with Scissor Base and Water Ballast	191419	398.00	386.00	366.00	354.25	191425	565.50	548.50	520.00	503.50
14.5' Kit with Ground Spike	191420	387.00	375.50	356.00	344.50	191426	599.00	581.00	551.00	533.00
14.5' Kit with Scissor Base and Water Ballast	191421	470.25	456.00	432.75	418.50	191427	682.00	661.50	627.50	607.00

Kit Includes: Hardware with Specified Base, Graphic and Soft Carry Case

USD MSRP (C)

Description	Product Size w/Ground Spike	Product Size w/Scissor Base	Finished Graphic Size	Product Wt. (Spike / Scissor)	Media (Single- / Double-Sided)
7'	31.5"W x 85.5"H x 2"D	43"W x 87.5"H x 22.75"D	View Online Template	5 lbs. / 10.25 lbs.	Super Poly Knit Fabric / Block-Out Polyester
10'	31.5"W x 117"H x 2"D	43"W x 119"H x 22.75"D	View Online Template	6.25 lbs. / 11.75 lbs.	Super Poly Knit Fabric / Block-Out Polyester
14.5'	31.5"W x 171.5"H x 2"D	43"W x 173.5"H x 22.75"D	View Online Template	8.4 lbs. / 13.25 lbs.	Super Poly Knit Fabric / Block-Out Polyester



Prices are subject to change; visit our website for the most current pricing.

Setup fee: \$20.00(G).

See pages 208-211 for additional information that may apply to your order.

AFTER FINAL PROOF APPROVAL
PRODUCTION LEAD TIME IS
2DAYS

PREMIUM SAIL SIGN

Premium sail signs are reinforced with black pole pockets constructed of high tensile strength elastic polyester binding.

- Sizes range from 6' to 17' tall
- Carbon composite poles are strong and flexible
- Artwork is dye sublimated on super poly knit fabric for single-sided sail signs and on block-out polyester for double-sided sail signs
- Flags used outdoors have a 90-day warranty; flags used indoors have a 1-year warranty
- Lifetime warranty on pole hardware



Suggested Uses

- Trade Shows
- Outdoor Branding
- Product Launches
- Sales Events



14.5', 15' and 17' double-sided spike kits include the Ground Anchor spike; attach to Ground spike for additional stability.



Double-sided flags feature a lightweight block-out polyester for increased flyability.



7' Blade 10' Rectangle 13' Razor 17' Blade 15' Teardrop 14.5' Rectangle 9' Razor 6' Teardrop

Single- or Double-Sided



Single-Sided

Image printed on one side; reverse image shows through back.



Double-Sided

Image printed correctly on both sides using a block-out polyester.



Uniform carbon composite overlay construction with high-gloss black paint finish.

Durable Construction

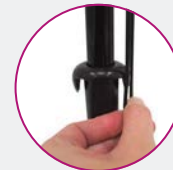

Flag attaches to a fixed hook using a bungee cord.



Pole pocket is made of high tensile strength elastic polyester binding.



Premium Blade Sail Sign

Single-Sided Flag

Double-Sided Flag

Description	Item #	1	2-5	6-11	12-24	Item #	1	2-5	6-11	12-24
7' Kit with Ground Spike	191515	258.25	250.50	237.75	230.00	191517	393.25	381.50	361.75	350.25
7' Kit with Three-Legged Base and Water Ballast	191516	299.25	290.25	275.25	266.25	191518	434.25	421.25	399.50	386.50
9' Kit with Ground Spike	191521	286.75	278.00	263.75	255.00	191523	436.50	423.25	401.50	388.50
9' Kit with Scissor Base and Water Ballast	191522	369.75	358.75	340.25	329.25	191524	519.50	504.00	478.00	462.50
13' Kit with Ground Spike	191527	348.75	338.25	320.75	310.25	191529	550.00	533.50	506.00	489.50
13' Kit with Scissor Base and Water Ballast	191528	432.00	419.00	397.25	384.50	191530	633.50	614.50	582.50	564.00
17' Kit with Ground Spike	191533	417.50	405.00	384.00	371.50	191535	663.00	643.00	610.00	590.00
17' Kit with Scissor Base and Water Ballast	191534	500.50	485.50	460.50	445.50	191536	746.00	723.50	686.50	664.00

Kit Includes: Hardware with Specified Base, Graphic and Soft Carry Case

USD MSRP (C)

Description	Product Size w/Ground Spike	Product Size w/Scissor Base	Finished Graphic Size	Product Wt. (Spike / Scissor)	Media (Single- / Double-Sided)
7'	19.75"W x 81.5"H x 2"D	28.375"W x 83.5"H x 15.25"D	View Online Template	3.25 lbs. / 3 lbs.	Super Poly Knit Fabric / Block-Out Polyester
9'	29"W x 106"H x 2"D	40.5"W x 108"H x 23"D	View Online Template	5 lbs. / 10.5 lbs.	Super Poly Knit Fabric / Block-Out Polyester
13'	32"W x 151"H x 2"D	43.5"W x 153"H x 23"D	View Online Template	7 lbs. / 12.5 lbs.	Super Poly Knit Fabric / Block-Out Polyester
17'	36"W x 205"H x 2"D	47.5"W x 207"H x 23"D	View Online Template	9.6 lbs. / 14.5 lbs.	Super Poly Knit Fabric / Block-Out Polyester



Premium Razor Sail Sign

Single-Sided Flag

Double-Sided Flag

Description	Item #	1	2-5	6-11	12-24	Item #	1	2-5	6-11	12-24
7' Kit with Ground Spike	190982	258.25	250.50	237.75	230.00	190980	393.25	381.50	361.75	350.25
7' Kit with Three-Legged Base and Water Ballast	190985	299.25	290.25	275.25	266.25	190984	434.25	421.25	399.50	386.50
9' Kit with Ground Spike	190667	286.75	278.00	263.75	255.00	190665	436.50	423.25	401.50	388.50
9' Kit with Scissor Base and Water Ballast	190757	369.75	358.75	340.25	329.25	190756	519.50	504.00	478.00	462.50
13' Kit with Ground Spike	190672	348.75	338.25	320.75	310.25	190670	550.00	533.50	506.00	489.50
13' Kit with Scissor Base and Water Ballast	190759	432.00	419.00	397.25	384.50	190758	633.50	614.50	582.50	564.00
17' Kit with Ground Spike	190677	417.50	405.00	384.00	371.50	190675	663.00	643.00	610.00	590.00
17' Kit with Scissor Base and Water Ballast	190761	500.50	485.50	460.50	445.50	190760	746.00	723.50	686.50	664.00

Kit Includes: Hardware with Specified Base, Graphic and Soft Carry Case

USD MSRP (C)

Description	Product Size w/Ground Spike	Product Size w/Scissor Base	Finished Graphic Size	Product Wt. (Spike / Scissor)	Media (Single- / Double-Sided)
7'	19.75"W x 81.5"H x 2"D	28.375"W x 83.5"H x 15.25"D	View Online Template	3.25 lbs. / 3 lbs.	Super Poly Knit Fabric / Block-Out Polyester
9'	29"W x 106"H x 2"D	40.5"W x 108"H x 22.75"D	View Online Template	5 lbs. / 10.5 lbs.	Super Poly Knit Fabric / Block-Out Polyester
13'	32"W x 151"H x 2"D	43.5"W x 153"H x 22.75"D	View Online Template	7 lbs. / 12.5 lbs.	Super Poly Knit Fabric / Block-Out Polyester
17'	36"W x 205"H x 2"D	47.5"W x 207"H x 22.75"D	View Online Template	9.6 lbs. / 14.5 lbs.	Super Poly Knit Fabric / Block-Out Polyester



Premium Teardrop Sail Sign

Single-Sided Flag

Double-Sided Flag

Description	Item #	1	2-5	6-11	12-24	Item #	1	2-5	6-11	12-24
6' Kit with Ground Spike	190976	258.25	250.50	237.75	230.00	190974	393.25	381.50	361.75	350.25
6' Kit with Three-Legged Base and Water Ballast	190979	299.25	290.25	275.25	266.25	190978	434.25	421.25	399.50	386.50
8' Kit with Ground Spike	190682	286.75	278.00	263.75	255.00	190680	436.50	423.25	401.50	388.50
8' Kit with Scissor Base and Water Ballast	190763	369.75	358.75	340.25	329.25	190762	519.50	504.00	478.00	462.50
11.5' Kit with Ground Spike	190687	348.75	338.25	320.75	310.25	190685	550.00	533.50	506.00	489.50
11.5' Kit with Scissor Base and Water Ballast	190765	432.00	419.00	397.25	384.50	190764	633.50	614.50	582.50	564.00
15' Kit with Ground Spike	190692	417.50	405.00	384.00	371.50	190690	663.00	643.00	610.00	590.00
15' Kit with Scissor Base and Water Ballast	190767	500.50	485.50	460.50	445.50	190766	746.00	723.50	686.50	664.00

Kit Includes: Hardware with Specified Base, Graphic and Soft Carry Case

USD MSRP (C)

Description	Product Size w/Ground Spike	Product Size w/Scissor Base	Finished Graphic Size	Product Wt. (Spike / Scissor)	Media (Single- / Double-Sided)
6'	23.25"W x 72.5"H x 2"D	31.875"W x 74.5"H x 15.25"D	View Online Template	3 lbs. / 2.75 lbs.	Super Poly Knit Fabric / Block-Out Polyester
8'	30.5"W x 91.5"H x 2"D	42"W x 93.5"H x 22.75"D	View Online Template	5 lbs. / 10.5 lbs.	Super Poly Knit Fabric / Block-Out Polyester
11.5'	36"W x 144.5"H x 2"D	47.5"W x 146.5"H x 22.75"D	View Online Template	7.5 lbs. / 13 lbs.	Super Poly Knit Fabric / Block-Out Polyester
15'	40"W x 194.5"H x 2"D	51.5"W x 196.5"H x 22.75"D	View Online Template	10.6 lbs. / 15.5 lbs.	Super Poly Knit Fabric / Block-Out Polyester



Premium Rectangle Sail Sign

Single-Sided Flag

Double-Sided Flag

Description	Item #	1	2-5	6-11	12-24	Item #	1	2-5	6-11	12-24
7' Kit with Ground Spike	190652	286.75	278.00	263.75	255.00	190650	436.50	423.25	401.50	388.50
7' Kit with Scissor Base and Water Ballast	190751	369.75	358.75	340.25	329.25	190750	519.50	504.00	478.00	462.50
10' Kit with Ground Spike	190657	348.75	338.25	320.75	310.25	190655	550.00	533.50	506.00	489.50
10' Kit with Scissor Base and Water Ballast	190753	432.00	419.00	397.25	384.50	190752	633.50	614.50	582.50	564.00
14.5' Kit with Ground Spike	190662	417.50	405.00	384.00	371.50	190660	663.00	643.00	610.00	590.00
14.5' Kit with Scissor Base and Water Ballast	190755	500.50	485.50	460.50	445.50	190754	746.00	723.50	686.50	664.00

Kit Includes: Hardware with Specified Base, Graphic and Soft Carry Case

USD MSRP (C)

Description	Product Size w/Ground Spike	Product Size w/Scissor Base	Finished Graphic Size	Product Wt. (Spike / Scissor)	Media (Single- / Double-Sided)
7'	31.5"W x 85.5"H x 2"D	43"W x 87.5"H x 22.75"D	View Online Template	5.25 lbs. / 10.5 lbs.	Super Poly Knit Fabric / Block-Out Polyester
10'	31.5"W x 117"H x 2"D	43"W x 119"H x 22.75"D	View Online Template	6.5 lbs. / 12 lbs.	Super Poly Knit Fabric / Block-Out Polyester
14.5'	31.5"W x 171.5"H x 2"D	43"W x 173.5"H x 22.75"D	View Online Template	8.6 lbs. / 13.5 lbs.	Super Poly Knit Fabric / Block-Out Polyester



Prices are subject to change; visit our website for the most current pricing.
 Setup fee: \$20.00(G).
 See pages 208-211 for additional information that may apply to your order.

AFTER FINAL PROOF APPROVAL
 PRODUCTION LEAD TIME IS
4 DAYS

Suggested Uses

- Sporting Arenas
- Universities
- Conventions
- Retail Stores

ELITE SAIL SIGN

Elite sail signs showcase brilliant colors and a long-lasting UV life making them exceptional for extended use.

- Sizes range from 6' to 17' tall
- Constructed of 200 denier nylon
- Available in single-sided only
- Carbon composite poles are strong and flexible
- Flags used outdoor have a 6-month warranty; flags used indoors have a 2-year warranty
- Lifetime warranty on pole hardware



8' Teardrop

9' Razor

17' Blade

15' Teardrop

13' Razor

7' Blade



Single-Sided



Single-Sided
Image printed on one side; reverse image shows through back.

Durable Construction

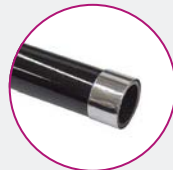

Uniform carbon composite overlay construction with high-gloss black paint finish.

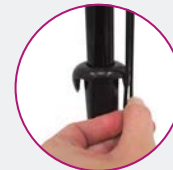

Flag attaches to a fixed hook using a bungee cord.



Pole is made of high tensile strength elastic polyester binding.



Elite Blade Sail Sign

Item #	Description	1	2-5	6-11	12-24
191800	7' Kit with Ground Spike	265.00	257.00	243.75	236.00
191801	7' Kit with Three-Legged Base and Water Ballast	306.00	296.75	281.50	272.25
191802	9' Kit with Ground Spike	294.25	285.25	270.50	261.75
191803	9' Kit with Scissor Base and Water Ballast	377.25	366.00	347.25	335.75
191804	13' Kit with Ground Spike	358.50	347.75	330.00	319.25
191805	13' Kit with Scissor Base and Water Ballast	441.75	428.50	406.50	393.25
191806	17' Kit with Ground Spike	429.50	416.75	395.25	382.25
191807	17' Kit with Scissor Base and Water Ballast	512.50	497.50	472.00	456.50

Kit Includes: Hardware with Specified Base, Graphic and Soft Carry Case

USD MSRP (C)

Description	Product Size w/Spike	Product Size w/Scissor Base	Finished Graphic Size	Product Wt. (Spike / Scissor)	Media
7'	19.75"W x 81.5"H x 2"D	28.375"W x 83.5"H x 15.25"D	View Online Template	3 lbs. / 2.75 lbs.	200 Denier Nylon
9'	29"W x 106"H x 2"D	40.5"W x 108"H x 23"D	View Online Template	4.5 lbs. / 10 lbs.	200 Denier Nylon
13'	32"W x 151"H x 2"D	43.5"W x 153"H x 23"D	View Online Template	6 lbs. / 11 lbs.	200 Denier Nylon
17'	36"W x 205"H x 2"D	47.5"W x 207"H x 23"D	View Online Template	7 lbs. / 12 lbs.	200 Denier Nylon



Elite Razor Sail Sign

Item #	Description	1	2-5	6-11	12-24
191812	7' Kit with Ground Spike	265.25	257.25	244.00	236.00
191813	7' Kit with Three-Legged Base and Water Ballast	306.00	297.00	281.50	272.50
191814	9' Kit with Ground Spike	294.25	285.50	270.75	262.00
191815	9' Kit with Scissor Base and Water Ballast	377.50	366.00	347.25	336.00
191816	13' Kit with Ground Spike	358.50	347.75	330.00	319.25
191817	13' Kit with Scissor Base and Water Ballast	441.75	428.50	406.50	393.25
191818	17' Kit with Ground Spike	429.50	416.75	395.25	382.25
191819	17' Kit with Scissor Base and Water Ballast	512.50	497.50	472.00	456.50

Kit Includes: Hardware with Specified Base, Graphic and Soft Carry Case

USD MSRP (C)

Description	Product Size w/Spike	Product Size w/Scissor Base	Finished Graphic Size	Product Wt. (Spike / Scissor)	Media
7'	19.75"W x 81.5"H x 2"D	28.375"W x 83.5"H x 15.25"D	View Online Template	3 lbs. / 2.75 lbs.	200 Denier Nylon
9'	29"W x 106"H x 2"D	40.5"W x 108"H x 23"D	View Online Template	4.5 lbs. / 10 lbs.	200 Denier Nylon
13'	32"W x 151"H x 2"D	43.5"W x 153"H x 23"D	View Online Template	6 lbs. / 11 lbs.	200 Denier Nylon
17'	36"W x 205"H x 2"D	47.5"W x 207"H x 23"D	View Online Template	7 lbs. / 12 lbs.	200 Denier Nylon



Elite Teardrop Sail Sign

Item #	Description	1	2-5	6-11	12-24
191824	6' Kit with Ground Spike	265.25	257.25	244.00	236.00
191825	6' Kit with Three-Legged Base and Water Ballast	306.00	297.00	281.50	272.50
191826	8' Kit with Ground Spike	294.25	285.50	270.75	262.00
191827	8' Kit with Scissor Base and Water Ballast	377.50	366.00	347.25	336.00
191828	11.5' Kit with Ground Spike	358.50	347.75	330.00	319.25
191829	11.5' Kit with Scissor Base and Water Ballast	441.75	428.50	406.50	393.25
191830	15' Kit with Ground Spike	429.50	416.75	395.25	382.25
191831	15' Kit with Scissor Base and Water Ballast	512.50	497.50	472.00	456.50

Kit Includes: Hardware with Specified Base, Graphic and Soft Carry Case

USD MSRP (C)

Description	Product Size w/Spike	Product Size w/Scissor Base	Finished Graphic Size	Product Wt. (Spike / Scissor)	Media
6'	23.25"W x 72.5"H x 2"D	31.875"W x 74.5"H x 15.25"D	View Online Template	3 lbs. / 2.75 lbs.	200 Denier Nylon
8'	30.5"W x 91.5"H x 2"D	42"W x 93.5"H x 22.75"D	View Online Template	5 lbs. / 10.5 lbs.	200 Denier Nylon
11.5'	36"W x 144.5"H x 2"D	47.5"W x 146.5"H x 22.75"D	View Online Template	7.5 lbs. / 13 lbs.	200 Denier Nylon
15'	40"W x 194.5"H x 2"D	51.5"W x 196.5"H x 22.75"D	View Online Template	10 lbs. / 15.5 lbs.	200 Denier Nylon



Prices are subject to change; visit our website for the most current pricing.
 Setup fee: \$20.00(G).
 See pages 208-211 for additional information that may apply to your order.

AFTER FINAL PROOF APPROVAL
 PRODUCTION LEAD TIME IS
4 DAYS

SOLID-COLOR SAIL SIGN

These stock color sail signs are vibrantly dyed on nylon to provide maximum color pop!

- Features a single stock color across the entire flag, including the pole pocket
- 26 color options to choose from
- Sail sign and pole pocket are constructed of 200 denier nylon
- Choose Value or Streamline sail sign option (see pages 84-87 for product details)
- Flags used outdoors have a 90-day warranty; flags used indoors have a 1-year warranty



Solid-Color Blade Sail Sign

Item #	Description	1	2-5	6-11	12-24
191548	10.5' Value Kit with Spike Base*	133.70	129.70	123.00	119.00
191549	10.5' Value Kit with Cross Base and Water Ballast*	188.40	182.80	173.30	167.80
191545	13' Streamline Kit with Spike Base	220.40	215.90	208.40	203.90
191546	13' Streamline Kit with Scissor Base and Water Ballast	303.50	296.50	285.00	278.00

Kit Includes: Hardware with Specified Base, Graphic and Soft Carry Case
 *Value kits do not include carry case. USD MSRP (C)

Description	Product Size w/Ground Spike	Product Size w/Scissor Base	Product Wt. (Spike / Scissor)	Media
Value	30.25"W x 124"H x 1.5"D	45.25"W x 127.375"H x 23.75"D	3 lbs. / 4.3 lbs.	Nylon
Streamline	32"W x 151"H x 2"D	43.5"W x 153"H x 23"D	5.75 lbs. / 6.75 lbs.	Nylon

STOCK SAIL SIGN COLORS

- Bell Blue PMS 641
- Purple PMS 2695
- Legion Blue PMS 2756
- Daffodil PMS 108
- UN Blue PMS 279
- White
- French Blue PMS 285
- Buff PMS 141
- Silver PMS 7534
- Mint Green PMS 360
- Emerald 3425
- FM Yellow PMS 106
- Pansy PMS 2617
- Irish Green PMS 349
- Charcoal PMS 424
- Spanish Yellow PMS 1235
- OG Red PMS 187
- Orange PMS 172
- Black
- Royal Blue PMS 286
- Maroon PMS 5115
- Dartmouth PMS 350
- Gray PMS 7538
- Canada Red PMS 186
- Spice Brown PMS 1545
- OG Blue PMS 2768

PMS colors are for reference only and may vary slightly from actual color.

STADIUM FLUTTER FLAG

These flags are designed to flutter in the breeze.

- The stadium shape has rounded corners for a contoured look
- Great flyability, even in the slightest breeze
- Available in 10', 15' and 18' sizes
- Flag and pole pocket are constructed of super poly knit fabric for single-sided flags and on block-out polyester for double-sided flags
- Flags have a 90-day warranty



Double-sided flags feature a lightweight block-out polyester for increased flyability.

Stadium Flutter Flag

Item #	Description	1	2-5	6-11	12-24
304866	10' Single-Sided Kit	261.75	240.75	225.00	209.50
304867	10' Double-Sided Kit	387.75	356.75	333.50	310.25
304868	15' Single-Sided Kit	324.75	298.75	279.25	259.75
304869	15' Double-Sided Kit	501.00	461.00	431.00	401.00
304870	18' Single-Sided Kit	387.75	356.75	333.50	310.25
304871	18' Double-Sided Kit	614.00	565.00	528.00	491.00

Kit Includes: Hardware with Spike Base, Graphic and Soft Carry Case USD MSRP (C)

Description	Product Size	Finished Graphic Size	Product Wt.	Media (Single- / Double-Sided)
10'	30"W x 120"H x 2"D	View Online Template	6.2 lbs.	Super Poly Knit Fabric / Block-Out Polyester
15'	30"W x 178.75"H x 2"D	View Online Template	8.5 lbs.	Super Poly Knit Fabric / Block-Out Polyester
18'	30"W x 218.5"H x 2"D	View Online Template	10 lbs.	Super Poly Knit Fabric / Block-Out Polyester



Carbon composite overlay construction with high-gloss black paint finish.

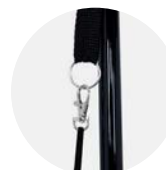

Flag attaches to a fixed hook using a bungee cord.

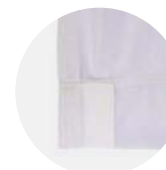

Pole pocket is made of the same fabric as the flag.

AFTER FINAL PROOF APPROVAL
 PRODUCTION LEAD TIME IS
4 DAYS

Prices are subject to change; visit our website for the most current pricing.
 Setup fee: \$20.00(G).
 See pages 208-211 for additional information that may apply to your order.

SOLID-COLOR FLUTTER FLAG

The combination of movement and vibrant stock colors are an economical way to draw attention.

- Flag and pole pocket are constructed of 200 denier nylon
- Stock colors pair well with any color scheme or logo, so they work well on their own or with branded promotional displays
- 26 color options to choose from
- The stadium shape has rounded corners for a contoured look
- Flags have a 90-day warranty



Solid-Color Flutter Flag

Item #	Description	1	2-5	6-11	12-24
304780	10' Kit	186.30	171.40	160.20	149.00
304781	15' Kit	218.90	201.40	188.30	175.10
304782	18' Kit	246.70	227.00	212.20	197.40

Kit Includes: Hardware with Spike Base, Graphic and Soft Carry Case USD MSRP (C)

Description	Product Size	Product Wt.	Media
10'	30"W x 120"H x 2"D	3.7 lbs.	Nylon
15'	30"W x 178.75"H x 2"D	5.5 lbs.	Nylon
18'	30"W x 218.5"H x 2"D	6.6 lbs.	Nylon

STOCK FLUTTER FLAG COLORS

- Bell Blue PMS 641
- French Blue PMS 285
- Pansy PMS 2617
- Black
- Gray PMS 7538
- Purple PMS 2695
- Buff PMS 141
- Irish Green PMS 349
- Royal Blue PMS 286
- Canada Red PMS 186
- Legion Blue PMS 2756
- Silver PMS 7534
- Charcoal PMS 424
- Maroon PMS 5115
- Spice Brown PMS 1545
- Daffodil PMS 108
- Mint Green PMS 360
- Spanish Yellow PMS 1235
- Dartmouth PMS 350
- OG Blue PMS 2768
- UN Blue PMS 279
- Emerald 3425
- OG Red PMS 187
- White
- FM Yellow PMS 106
- Orange PMS 172

PMS colors are for reference only and may vary slightly from actual color.



MINI TEARDROP SAIL SIGN

This small, versatile flag is a creative option for advertising or showing off team spirit.

- Four hardware attachment styles available
- Hardware-only options available online, allowing you to change out the attachment style
- Artwork is dye sublimated on super poly knit fabric for single-sided sail signs and on block-out polyester for double-sided sail signs
- Minimum quantity of three
- Flags used outdoors have a 90-day warranty; flags used indoors have a 1-year warranty



Mini Teardrop Sail Sign

Item #	Description	3-5	6-11	12-24	25-49
191380	Vehicle Single-Sided Kit	44.41	43.13	42.24	40.78
191381	Vehicle Double-Sided Kit	75.75	73.85	72.30	69.90
191382	Clip-On Single-Sided Kit	43.09	41.87	41.02	39.61
191383	Clip-On Double-Sided Kit	74.40	72.55	71.10	68.70
191384	Suction Cup Single-Sided Kit	48.31	46.83	45.87	44.25
191385	Suction Cup Double-Sided Kit	79.65	77.55	75.95	73.35
191391	Magnet Single-Sided Kit	50.95	49.35	48.35	46.60
191392	Magnet Double-Sided Kit	82.30	80.05	78.40	75.70

Kit Includes: Specified Hardware and Graphic USD MSRP (C)

Description	Product Size	Finished Graphic Size	Product Wt.	Media (Single- / Double-Sided)
Mini Vehicle	15.5"W x 25.875"H x 2.875"D	View Online Template	4.1 oz.	Super Poly Knit Fabric / Block-Out Polyester
Mini Clip-On	15.5"W x 26"H x 1.875"D	View Online Template	3.3 oz.	Super Poly Knit Fabric / Block-Out Polyester
Mini Suction Cup	17"W x 23.5"H x 3.5"D	View Online Template	5.1 oz.	Super Poly Knit Fabric / Block-Out Polyester
Mini Magnet	14.25"W x 24.75"H x 2.75"D	View Online Template	8 oz.	Super Poly Knit Fabric / Block-Out Polyester



Prices are subject to change; visit our website for the most current pricing.

Setup fee: \$20.00(G).

See pages 208-211 for additional information that may apply to your order.

AFTER FINAL PROOF APPROVAL
PRODUCTION LEAD TIME IS
4 DAYS



Item #190743
Wall mount
(indoor/outdoor)

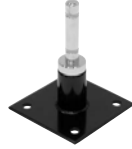

Item #190744
Floor mount
(indoor/outdoor)



Item #190746
Flat base
(indoor/outdoor)



Item #190699
Mount for fence posts
for 6'-15' sail signs



Item #190708
Round water ballast for
6'-13' sail signs
(indoor/outdoor)



Item #190710
Square water ballast for
14.5'-17' sail signs
(indoor/outdoor)

SAIL SIGN & FLUTTER FLAG ACCESSORIES



Sail Sign & Flutter Flag Accessories

Item #	Description	Product Wt.	1	2-5	6-11	12-24
190714	3-Legged Base	1.25 lbs.	40.39	39.18	37.16	35.95
190746	Flat Base	21.8 lbs.	151.00	146.50	138.90	134.40
190744	Floor Mount Hardware	1.4 lbs.	42.79	41.51	39.37	38.08
190706	Ground Spike	2 lbs.	54.25	52.60	49.90	48.30
190748	Ground Spike Anchor	0.6 lb.	16.00	15.52	14.72	14.24
190711	Heavy-Duty Cross Base	9 lbs.	95.65	92.80	88.00	85.15
240522	Mount for Deluxe Tents	2 lbs.	42.94	42.08	41.22	39.94
240529	Mount for Elite Tents	2.6 lbs.	103.00	100.90	98.90	95.80
190699	Mount for Fence Posts	1.4 lbs.	44.04	42.72	40.52	39.20
240523	Mount for Premium and Premium Gable Tents	2 lbs.	70.00	69.35	66.80	65.80
240521	Mount for Standard Tents	2 lbs.	39.39	38.60	37.81	36.63
190708	Round Water Ballast	0.5 lb.	54.75	53.10	50.35	48.75
190707	Scissor Base	7 lbs.	82.70	80.20	76.10	73.60
190747	Simple Spike*	1.4 lbs.	25.17	24.41	23.16	22.40
190710	Square Water Ballast	0.5 lb.	54.75	53.10	50.35	48.75
220082	Universal Product Case	7 lbs.	156.10	153.00	148.30	145.20
191591	Value Cross Base*	2.8 lbs.	39.77	38.58	36.59	35.40
191590	Value Spike*	2 lbs.	39.77	38.58	36.59	35.40
220351	Value Sail Sign Soft Carry Case	0.8 lb.	21.40	20.97	20.33	19.90
190709	Vehicle Base	4.5 lbs.	82.70	80.20	76.10	73.60
190743	Wall Mount Hardware	1.6 lbs.	42.79	41.51	39.37	38.08

*Covered by a 90-day product warranty

USD MSRP (C)

**HARDWARE SHIPS
SAME DAY**
WHEN ORDERED BEFORE 2 PM CENTRAL

Prices are subject to change; visit our website for the most current pricing.
See pages 208-211 for additional information that may apply to your order.

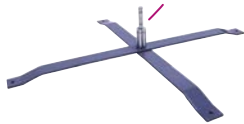

Item #190711
Heavy-duty cross base
(indoor/outdoor)



Item #190709
Vehicle base
(outdoor)



Item #190707
Scissor base
(indoor/outdoor)



Item #190706
Ground spike
(outdoor)



Item #190714
Three-legged base for 6' Teardrop
& 7' Razor/Blade (indoor)



Item #191591
Value cross base
(indoor/outdoor)*



Item #191590
Value spike
(outdoor)*



Item #190748
Ground spike anchor (outdoor)

Requires a Ground,
Value or Simple
spike for use.



Item #190747
Simple spike
(outdoor)*



Item #220351
Value sail sign
carry case



Item #220082
Universal product case
(holds up to three sail sign kits)



Item #240522
Mount for Deluxe tents
shown on a 10' Deluxe tent
(sold separately); additional
mount options available



TENTS

When choosing a tent
have you considered...

- **LOCATION** - Where will this tent be used?
- **LONGEVITY** - Will you be using your tent for one or multiple events?
- **MESSAGE** - What is the desired impact of your promotional message?
- **WEATHER** - Will you need additional reinforcement against wind?
- **ACCESSORIES** - Would you like to add additional ad space?



TENT COMPARISON CHART

BEST SELLERS ★ - 10' IS OUR MOST POPULAR SIZE		FRAME / CANOPY WARRANTY (FRAME / 600 DENIER / UV-PRINTED)	CONSTRUCTION	WIND RATING	FRAME WEIGHT	TOTAL SIZE	STOCK CANOPY COLORS
ECONOMY	PG #						
NEW! 5' & 5' Plus	99	6 months / 1 year	 STEEL 1.1875"W LEGS • 0.9 mm white finish powder-coated steel • plastic release button for height adjustments • ABS nylon joints		32 lbs.	57.875"W x 116.875"-124.625"H x 57.875"D	dye sublimation only
10' & 10' Plus	99						
STANDARD	PG #						
NEW! 10' ★	100	Lifetime / 1 year / 3 year	 STEEL 1.125"W LEGS • 1 mm powder-coated steel • plastic push button for height adjustments • ABS nylon joints		36 lbs.	118.5"W x 127.5"-140"H x 118.5"D	 dye sublimation only
NEW! 10' Wall Kit	109						
DELUXE	PG #						
6'	101	Lifetime / 1 year / 3 year	 STEEL 1.25"W LEGS • 1 mm powder-coated steel • lever for height adjustments • ABS glass-filled nylon joints		38.5 lbs.	72"W x 109"-121.5"H x 72"D	dye sublimation only
8' ★	101				44.5 lbs.	96"W x 117.5"-130"H x 96"D	
NEW! 10' ★	102				48 lbs.	118.5"W x 127"-139.5"H x 118.5"D	
OMNI	PG #						
NEW! 10'	104	Lifetime / 1 year / 3 year	 ALUMINUM 1.25" DIA. OCTAGON LEGS • 0.8 mm anodized aluminum frame • 1 mm powder-coated steel truss • lever for height adjustments • ABS glass-filled nylon joints		41.2 lbs.	119.5"W x 115.25"-126.875"H x 119.5"D	
PREMIUM	PG #						
NEW! 10' ★	105	Lifetime / 1 year / 3 year	 ALUMINUM 1.75" DIA. HEXAGON LEGS • 0.8 mm anodized aluminum • lever for height adjustments • ABS glass-filled nylon joints		36.5 lbs.	118"W x 126.75"-139.25"H x 118"D	 dye sublimation only
NEW! 10' Wall Kit	109				46 lbs.	175.5"W x 126.75"-139.25"H x 118.25"D	
15'	106				62.75 lbs.	234.5"W x 126.75"-139.25"H x 118.25"D	
20' ★	106						
PREMIUM GABLE	PG #						
10'	107	Lifetime / 1 year	 ALUMINUM 1.75" DIA. HEXAGON LEGS • 0.8 mm anodized aluminum • lever for height adjustments • ABS glass-filled nylon joints		37.4 lbs.	118"W x 119.25"-131.5"H x 118"D	 white only
15'	107				47.2 lbs.	175.5"W x 119.25"-131.75"H x 118.25"D	
20'	107				64 lbs.	234.5"W x 119.25"-131.75"H x 118.25"D	
ELITE	PG #						
10'	108	Lifetime / 1 year / 3 year	 ALUMINUM 2.125" DIA. HEXAGON LEGS • 1.55 mm anodized aluminum • lever for height adjustments • machined aluminum joints		63 lbs.	118"W x 116.75"-128.25"H x 118"D	

 **Beaufort Wind Rating:** Select products have been rated on the Beaufort Wind Scale. See rating icon underneath the product name. Wind ratings were determined utilizing all available securing/stabilizing options sold with or offered for the product. Review the Beaufort Scale on page 211 for additional details.
Disclaimer: Wind rating conducted in a controlled environment. Outdoor products should be taken down if bad weather is likely. Wind gusts and heavy rain could reduce the wind resistance of these products.

QUICK & EASY SETUP FEATURES



Sets up in minutes.



Adjust tent height with the push of a button.



Crank-up canopy creates a taut, clean peak. *Excludes Economy, Elite and Omni tents.



Secure tent to the ground with stake kit.



Collapses easily to store in a rolling soft case with wheels. *Excludes Economy & Omni tent.



Easy-Glide Tent Feet for mobility.

CANOPY PRINT METHODS

THREE OPTIONS AVAILABLE



FULL-COLOR IMPRINT

Imprinted on peak and valance locations of your choice.*

- One imprint per location (peak or valance)
- Only one setup fee per tent
- Maximum imprint locations listed on individual pages
- 10' canopies are available in eight stock colors (see below); vented canopy available in white only
- Canopy is constructed of 600 denier polyester

*Vector artwork required.



DYE SUBLIMATION

Covers the entire canopy with vibrant, full-color artwork.*

- One piece per side for a continuous image from peak to valance with no seams (excludes Economy)
- Economy features a three-piece construction with separate pieces for the peak, valance and main body
- Artwork is vibrantly dye sublimated on 600 denier polyester

*Not available on vented canopies.



UV-PRINTED

Covers the entire canopy with vibrant, full-color artwork.*

- One piece per side for a continuous image from peak to valance with no seams
- Internal corner seams for a seamless look
- Best fade resistance available with a three-year warranty
- Artwork is vibrantly printed on 600 denier polyester
- Not eligible for Rush Service

*Available on 10' Standard, Deluxe, Omni, Premium and Elite tents. Not available on vented canopies.



Full-color imprint and dye sublimated canopies have a one-year warranty.



UV-printed canopies have a three-year warranty.

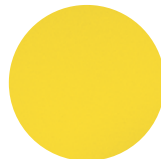

Constructed of durable 600 denier polyester.



Stock throw colors closely align with stock tent colors; excludes Blaze Orange. See page 11.



Flame retardant certified for exhibit hall use.

10' CANOPY STOCK COLORS



PMS colors are for reference only and may vary slightly from actual color.

Economy Kit Includes:



Stake Kit

Economy Plus Kit Includes:



Soft Carry Case with Wheels



Stake Kit



NEW SIZE

10'

5'

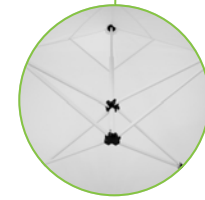

Spring-loaded center pole sets up quickly without a center pole crank.

TENTS

5' & 10' ECONOMY TENTS

Ideal for short-term use, these Economy tents are where affordability and functionality meet.

- 1.1875"W square legs constructed of 0.9 mm white finish powder coated steel
- ABS nylon joints
- Spring-loaded center pole allows for quick and easy peak setup
- 10' tents are compatible with Deluxe half wall kits; 5' Economy half wall kits available (see page 110)
- Canopy is available in full-bleed dye sublimation featuring three-piece construction with separate pieces for the peak, valance and main body
- Quick Ship available online for 1- or 2-location full-color imprint tent kits
- Economy Plus includes soft carry case with wheels



Economy Tent

Item #	Description	1	2-5	6-11	12-24
241300	5' Dye Sublimation Kit	350.00	343.00	336.00	325.50
241239	10' Dye Sublimation Kit	809.00	805.00	801.00	797.00
Soft Carry Case Not Included					USD MSRP (C)

Description	Product Size	Dye Sub Graphic Size	Product Wt.
5'	57.875"W x 116.875"H -124.625"H x 57.875"D	View Online Template	37 lbs.
10'	117.5"W x 128.75"H -136.5"H x 117.5"D	View Online Template	51 lbs.

Economy Plus Tent

Item #	Description	1	2-5	6-11	12-24
241301	5' Dye Sublimation Kit	390.00	382.25	374.50	362.75
241240	10' Dye Sublimation Kit	911.00	906.50	902.00	897.50
					USD MSRP (C)

Description	Product Size	Dye Sub Graphic Size	Product Wt.
5'	57.875"W x 116.875"H -124.625"H x 57.875"D	View Online Template	42.8 lbs.
10'	117.5"W x 128.75"H -136.5"H x 117.5"D	View Online Template	56.8 lbs.



Easy-Glide Tent Feet allow the tent frame to slide on dirt and grass, preventing the legs from catching. US Patent #D760857



Legs feature plastic release buttons for easy height adjustments.

Shipping Case: Double-wall shipping box.

Prices are subject to change; visit our website for the most current pricing. Setup fee: \$20.00(G). See pages 208-211 for additional information that may apply to your order.

AFTER FINAL PROOF APPROVAL PRODUCTION LEAD TIME IS **7 DAYS**



10' tent shown with UV printing

NEW
UV-PRINTED
CANOPY
OPTION

Choose Your Imprint Locations



One imprint per location (peak or valance).
Maximum of four locations per tent.
Only one setup fee per tent.

Kit Includes:



Soft Carry Case with Wheels



Stake Kit



10' STANDARD TENT

This popular tent strikes a perfect balance between cost effectiveness and portability.

- 1.125"W square legs constructed of 1 mm pebble powder-coated steel
- ABS nylon joints
- Crank-up canopy creates a taut, clean peak
- Canopy available in eight stock colors (see page 98), with full-bleed dye sublimation or with full-bleed UV printing



10' Standard Tent

Item #	Description	1	2-5	6-11	12-24
240611	Full-Color Imprint Kit (1 Location)	634.00	621.50	608.50	589.50
240612	Full-Color Imprint Kit (2 Locations)	716.00	701.50	687.50	666.00
240614	Full-Color Imprint Kit (4 Locations)	857.50	840.50	823.00	797.50
240619	Dye Sublimation Kit	1272.00	1247.00	1221.00	1183.00
241420	UV-printed Kit	1600.00	1568.00	1536.00	1488.00

USD MSRP (C)

Product Size 118.5"W x 127.5"H-140"H x 118.5"D **Imprint Graphic Size** Peak: 44"W x 24"H; Valance: 60"W x 8"H **Dye Sub / UV Graphic Size** View Online Template **Product Wt.** 51.5 lbs.



Easy-Glide Tent Feet allow the tent frame to slide on dirt and grass, preventing the legs from catching. US Patent #D760857



Legs feature plastic push buttons for pinch-free height adjustments.

Shipping Case: Double-wall shipping box.

Prices are subject to change; visit our website for the most current pricing.
Setup fee: \$20.00(G).
See pages 208-211 for additional information that may apply to your order.

IMPRINT DYE SUB UV-PRINTED
AFTER FINAL PROOF APPROVAL
PRODUCTION LEAD TIME IS
4-7-OR-10 DAYS

Kit Includes:



Soft Carry Case with Wheels



Stake Kit



6'



8'

6' & 8' DELUXE TENTS

6' and 8' tents are compact enough for use indoors or in tight spaces.

- 1.25"W square legs constructed of 1 mm pebble powder-coated steel
- ABS glass-filled nylon joints
- Crank-up canopy creates a taut, clean peak
- Canopy is available with full-bleed dye sublimation



6' Deluxe Tent

Item #	Description	1	2-5	6-11	12-24
240809	Dye Sublimation Kit	1074.00	1053.00	1031.00	999.00

USD MSRP (C)

Product Size 72"W x 109"-121.5"H x 72"D
Dye Sub Graphic Size View Online Template
Product Wt. 48.5 lbs.

8' Deluxe Tent

Item #	Description	1	2-5	6-11	12-24
240829	Dye Sublimation Kit	1309.00	1283.00	1257.00	1217.00

USD MSRP (C)

Product Size 96"W x 117.5"-130"H x 96"D
Dye Sub Graphic Size View Online Template
Product Wt. 58 lbs.



Easy-Glide Tent Feet allow the tent frame to slide on dirt and grass, preventing the legs from catching. US Patent #D760857



Legs feature levers for easy height adjustments.

Shipping Case: Double-wall shipping box.

Prices are subject to change; visit our website for the most current pricing.
 Setup fee: \$20.00(G).
 See pages 208-211 for additional information that may apply to your order.

AFTER FINAL PROOF APPROVAL
 PRODUCTION LEAD TIME IS
7 DAYS



10' tent shown with UV printing

NEW
UV-PRINTED
CANOPY
OPTION

Choose Your Imprint Locations



One imprint per location (peak or valance).
Maximum of four locations per tent.
Only one setup fee per tent.

Kit Includes:



Soft Carry Case with Wheels



Stake Kit



10' DELUXE TENT

Designed for frequent use, this tent features a stronger, heavier steel frame than that of the Standard.

- 1.25"W square legs constructed of 1 mm pebble powder-coated steel
- ABS glass-filled nylon joints
- Crank-up canopy creates a taut, clean peak
- Canopy available in eight stock colors (see page 98), with full-bleed dye sublimation or with full-bleed UV printing



10' Deluxe Tent

Item #	Description	1	2-5	6-11	12-24
240621	Full-Color Imprint Kit (1 Location)	771.00	755.50	740.00	717.00
240622	Full-Color Imprint Kit (2 Locations)	852.00	835.00	818.00	792.50
240624	Full-Color Imprint Kit (4 Locations)	940.00	921.00	902.50	874.00
240629	Dye Sublimation Kit	1355.00	1328.00	1301.00	1260.00
241421	UV-Printed Kit	1800.00	1764.00	1728.00	1674.00

USD MSRP (C)

Product Size 118.5"W x 127"-139.5"H x 118.5"D **Imprint Graphic Size** Peak: 44"W x 24"H; Valance: 60"W x 8"H **Dye Sub / UV Graphic Size** View Online Template **Product Wt.** 63.5 lbs.



Easy-Glide Tent Feet allow the tent frame to slide on dirt and grass, preventing the legs from catching. US Patent #D760857



Legs feature levers for easy height adjustments.

Shipping Case: Double-wall shipping box.

Prices are subject to change; visit our website for the most current pricing.
Setup fee: \$20.00(G).
See pages 208-211 for additional information that may apply to your order.

IMPRINT — DYE SUB — UV-PRINTED
AFTER FINAL PROOF APPROVAL
PRODUCTION LEAD TIME IS
4 — OR — 7 — OR — 10 DAYS

Choose Your Imprint Locations



One imprint per location (peak or valance).
Maximum of four locations per tent.
Only one setup fee per tent.

Kit Includes:



Soft Carry Case with Wheels



Stake Kit



Premium 10' tent with full-color imprint (4 locations)

Vented canopy is available in white only.

Deluxe 10' tent with full-color imprint (2 locations)



10' TENT WITH VENTED CANOPY

These tents feature a white vented canopy to keep them stable when the wind picks up.

- Canopy available in white only
- Crank-up canopy creates a taut, clean peak
- Choose Deluxe or Premium tent hardware (see pages 102 and 105 for hardware details)



10' Deluxe Tent with Vented Canopy

Item #	Description	1	2-5	6-11	12-24
240351	Full-Color Imprint Kit (1 Location)	819.00	802.50	786.00	761.50
240352	Full-Color Imprint Kit (2 Locations)	863.00	845.50	828.50	802.50
240354	Full-Color Imprint Kit (4 Locations)	951.00	932.00	913.00	884.50

USD MSRP (C)

Product Size 118.5"W x 127"-139.5"H x 118.5"D
Imprint Graphic Size Peak: 44"W x 24"H; Valance: 60"W x 8"H
Product Wt. 62 lbs.

10' Premium Tent with Vented Canopy

Item #	Description	1	2-5	6-11	12-24
240411	Full-Color Imprint Kit (1 Location)	938.50	919.50	901.00	873.00
240412	Full-Color Imprint Kit (2 Locations)	982.00	962.50	942.50	913.50
240414	Full-Color Imprint Kit (4 Locations)	1070.00	1049.00	1027.00	995.00

USD MSRP (C)

Product Size 120"W x 126.75"-139.25"H x 120"D
Imprint Graphic Size Peak: 44"W x 24"H; Valance: 60"W x 8"H
Product Wt. 50.5 lbs.



Vented canopy peak allows air to flow through to prevent wind damage.



Easy-Glide Tent Feet allow the tent frame to slide on dirt and grass, preventing the legs from catching. US Patent #D760857

Shipping Case: Double-wall shipping box.

Prices are subject to change; visit our website for the most current pricing.
Setup fee: \$20.00(G).
See pages 208-211 for additional information that may apply to your order.

AFTER FINAL PROOF APPROVAL
PRODUCTION LEAD TIME IS
4 DAYS



10' tent with dye sublimation

Central hub makes setup fast and easy.

Tent wheels make moving a breeze whether it's in use or being transported to your event.

Choose Your Imprint Locations



One imprint per location (peak or valance).
Maximum of four locations per tent.
Only one setup fee per tent.

Kit Includes:



Soft Case



Stake Kit



10' OMNI TENT

This tent is designed for portability. It features an innovative central hub design that makes it a snap to set up.

- 1.25" diameter octagon legs constructed of 0.8 mm anodized aluminum
- Canopy is constructed of durable, weather-resistant 600 denier polyester
- Hybrid construction with aluminum legs and steel truss
- The included soft case slides over the frame when it's fully collapsed
- The tent can be secured to the ground with the included stake kit
- Frame must be secured to the ground to prevent wind damage (failure to secure the tent voids the warranty)
- Canopy available in eight stock colors (see page 98), with full-bleed dye sublimation or with full-bleed UV printing

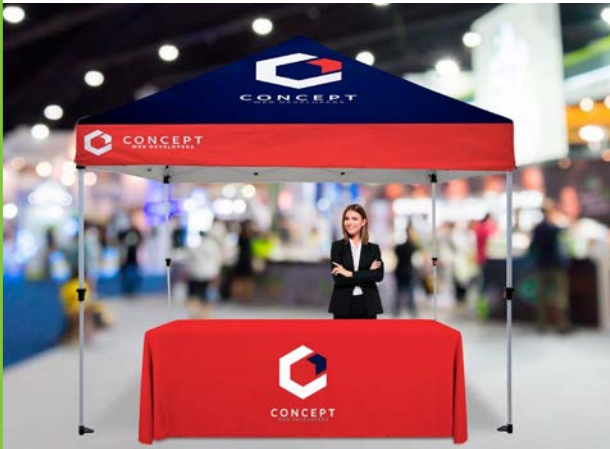

Easy-Glide Tent Feet allow the tent frame to slide on dirt and grass, preventing the legs from catching. US Patent #D760857



Legs feature levers for easy height adjustments.

10' Omni Tent

Item #	Description	1	2-5	6-11	12-24
241271	Full-Color Imprint Kit (1 Location)	940.00	921.00	902.50	874.00
241272	Full-Color Imprint Kit (2 Locations)	1025.00	1005.00	984.00	953.00
241274	Full-Color Imprint Kit (4 Locations)	1210.00	1186.00	1162.00	1125.00
241279	Dye Sublimation Kit	1400.00	1372.00	1344.00	1302.00
241425	UV-Printed Kit	1875.00	1838.00	1800.00	1744.00
USD MSRP (C)					

Product Size	Imprint Graphic Size	Dye Sub Graphic Size	Product Wt.
119.5"W x 115.25"H x 126.875"H x 119.5"D	Peak: 44"W x 24"H, Valance: 60"W x 8"H	View Online Template	52.5 lbs.

IMPRINT — DYE SUB — UV-PRINTED
4 — OR — 7 — OR — 10 DAYS
AFTER FINAL PROOF APPROVAL
 PRODUCTION LEAD TIME IS

Prices are subject to change; visit our website for the most current pricing.
 Setup fee: \$20.00(G).
 See pages 208-211 for additional information that may apply to your order.

Choose Your Imprint Locations



One imprint per location (peak or valance).
Maximum of four locations per tent.
Only one setup fee per tent.

Kit Includes:



Soft Carry Case with Wheels



Stake Kit



10' tent shown with UV printing



10' PREMIUM TENT

This Premium tent features a strong aluminum frame with sturdy hexagon-shaped legs.

- 1.75" diameter hexagon-shaped legs constructed of 0.8 mm anodized aluminum
- ABS glass-filled nylon joints
- Crank-up canopy creates a taut, clean peak
- Canopy available in eight stock colors (see page 98), with full-bleed dye sublimation or with full-bleed UV printing



10' Premium Tent

Item #	Description	1	2-5	6-11	12-24
240631	Full-Color Imprint Kit (1 Location)	909.00	891.00	872.50	845.50
240632	Full-Color Imprint Kit (2 Locations)	972.00	952.50	933.00	904.00
240634	Full-Color Imprint Kit (4 Locations)	1060.00	1039.00	1018.00	986.00
240639	Dye Sublimation Kit	1474.00	1445.00	1415.00	1371.00
241422	UV-Printed Kit	1950.00	1911.00	1872.00	1814.00

USD MSRP (C)

Product Size 118"W x 126.75"H - 139.25"H x 118"D **Imprint Graphic Size** Peak: 44"W x 24"H; Valance: 60"W x 8"H **Dye Sub / UV Graphic Size** View Online Template **Product Wt.** 52 lbs.



Easy-Glide Tent Feet allow the tent frame to slide on dirt and grass, preventing the legs from catching. US Patent #D760857



Legs feature levers for easy height adjustments.

Prices are subject to change; visit our website for the most current pricing.
Setup fee: \$20.00(G).
See pages 208-211 for additional information that may apply to your order.

IMPRINT DYE SUB UV-PRINTED
AFTER FINAL PROOF APPROVAL
PRODUCTION LEAD TIME IS
4 OR 7 OR 10 DAYS

AVAILABLE IN 5 STOCK COLORS

15' & 20' CANOPY STOCK COLORS

- White
- Cherry PMS 1795
- Cobalt PMS 7683
- Navy PMS 2767
- Black



15' tent shown in black with full-color imprint (12 locations)



20' tent with dye sublimation

Choose Your Imprint Locations

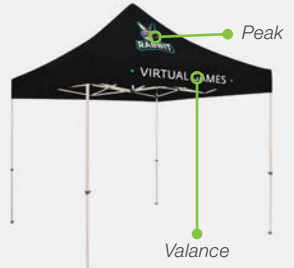

One imprint per location (peak or valance). Maximum of twelve locations per tent. Only one setup fee per tent.

Kit Includes:



Soft Carry Case with Wheels



Stake Kit

MORE OPTIONS
AVAILABLE ONLINE

15' & 20' PREMIUM TENTS

Our two largest tent sizes give you ample space for displaying your products, serving refreshments or just keeping out of the sun.

- 1.75" diameter hexagon legs constructed of 0.8 mm anodized aluminum
- ABS glass-filled nylon joints
- Crank-up canopy creates a taut, clean peak
- Canopy available in white, cherry, cobalt, navy, black or with full-bleed dye sublimation



Easy-Glide Tent Feet allow the tent frame to slide on dirt and grass, preventing the legs from catching. US Patent #D760857



Legs feature levers for easy height adjustments.



10' x 15' Premium Tent

Item #	Description	1	2-5	6-11	12-24
240550	Unimprinted Kit	959.00	940.00	920.50	892.00
240551	Full-Color Imprint Kit (1 Location)	1041.00	1020.00	999.00	968.00
240552	Full-Color Imprint Kit (2 Locations)	1123.00	1101.00	1078.00	1044.00
240554	Full-Color Imprint Kit (4 Locations)	1223.00	1199.00	1174.00	1137.00
240556	Full-Color Imprint Kit (6 Locations)	1307.00	1281.00	1255.00	1216.00
240558	Full-Color Imprint Kit (8 Locations)	1390.00	1362.00	1334.00	1293.00
240560	Full-Color Imprint Kit (10 Locations)	1482.00	1452.00	1423.00	1378.00
240562	Full-Color Imprint Kit (12 Locations)	1485.00	1455.00	1426.00	1381.00
240563	Dye Sublimation Kit	1868.00	1831.00	1793.00	1737.00

USD MSRP (C)

Product Size	Imprint Graphic Size	Dye Sub Graphic Size	Product Wt.
175.5"W x 126.75"-139.25"H x 118.25"D	Peak: 44"W x 24"H Valance: 60"W x 8"H	View Online Template	70.5 lbs.

10' x 20' Premium Tent

Item #	Description	1	2-5	6-11	12-24
240570	Unimprinted Kit	1090.00	1068.00	1046.00	1014.00
240571	Full-Color Imprint Kit (1 Location)	1172.00	1149.00	1125.00	1090.00
240572	Full-Color Imprint Kit (2 Locations)	1254.00	1229.00	1204.00	1166.00
240574	Full-Color Imprint Kit (4 Locations)	1418.00	1390.00	1361.00	1319.00
240576	Full-Color Imprint Kit (6 Locations)	1595.00	1563.00	1531.00	1483.00
240578	Full-Color Imprint Kit (8 Locations)	1688.00	1654.00	1620.00	1570.00
240580	Full-Color Imprint Kit (10 Locations)	1706.00	1672.00	1638.00	1587.00
240582	Full-Color Imprint Kit (12 Locations)	1709.00	1675.00	1641.00	1589.00
240583	Dye Sublimation Kit	2279.00	2233.00	2188.00	2119.00

USD MSRP (C)

Product Size	Imprint Graphic Size	Dye Sub Graphic Size	Product Wt.
234.5"W x 126.75"-139.25"H x 118.25"D	Peak: 44"W x 24"H Valance: 60"W x 8"H	View Online Template	92 lbs.

UNIMPRINTED CANOPY LEAD TIME: SHIPS SAME DAY WHEN ORDERED BEFORE 2 PM CENTRAL

Shipping Case: Double-wall shipping box.

IMPRINT DYE SUB
AFTER FINAL PROOF APPROVAL
PRODUCTION LEAD TIME IS
4-7 DAYS

Prices are subject to change; visit our website for the most current pricing.

Setup fee: \$20.00(G).

See pages 208-211 for additional information that may apply to your order.

Choose Your Imprint Locations



One imprint per location (peak or valance).
Maximum of four locations per 10' tent;
Maximum of 12 locations per 15' & 20' tents.
Only one setup fee per tent.

Kit Includes:



Soft Carry Case with Wheels



Stake Kit



10' tent with dye sublimation



Center poles crank up to create a taut gable shape.



PREMIUM GABLE TENTS

This tent stands out from the crowd with a unique gable shape, allowing for more visible space to share your message.

- Available in 10', 15' and 20' sizes
- 1.75" diameter hexagon legs constructed of 0.8 mm anodized aluminum
- ABS glass-filled nylon joints
- 10' x 10' tents have three center poles, 10' x 15' have four center poles and 10' x 20' have five center poles
- 10' canopy available in eight stock colors (see page 98) or with full-bleed dye sublimation
- 15' and 20' canopies available in white or with full-bleed dye sublimation



10' x 10' Premium Gable Tent

Item #	Description	1	2-5	6-11	12-24
241121	Full-Color Imprint Kit (1 Location)	1018.00	998.00	977.00	947.00
241122	Full-Color Imprint Kit (2 Locations)	1100.00	1078.00	1056.00	1023.00
241124	Full-Color Imprint Kit (4 Locations)	1264.00	1239.00	1213.00	1176.00
241129	Dye Sublimation Kit	1775.00	1740.00	1704.00	1651.00

USD MSRP (C)

Product Size	Imprint Graphic Size	Dye Sub Graphic Size	Product Wt.
118"W x 119.25"-131.75"H x 118"D	Flat Peak: 44"W x 11.25"H Sloping Peak: 44"W x 24"H Valance: 60"W x 8"H	View Online Template	55 lbs.



Easy-Glide Tent Feet allow the tent frame to slide on dirt and grass, preventing the legs from catching. US Patent #D760857



Legs feature levers for easy height adjustments.

10' x 15' Premium Gable Tent

Item #	Description	1	2-5	6-11	12-24
241130	Unimprinted Kit	1062.00	1041.00	1020.00	988.00
241131	Full-Color Imprint Kit (1 Location)	1144.00	1121.00	1098.00	1064.00
241132	Full-Color Imprint Kit (2 Locations)	1226.00	1201.00	1177.00	1140.00
241134	Full-Color Imprint Kit (4 Locations)	1390.00	1362.00	1334.00	1293.00
241136	Full-Color Imprint Kit (6 Locations)	1554.00	1523.00	1492.00	1445.00
241138	Full-Color Imprint Kit (8 Locations)	1731.00	1696.00	1662.00	1610.00
241140	Full-Color Imprint Kit (10 Locations)	1784.00	1748.00	1713.00	1659.00
241142	Full-Color Imprint Kit (12 Locations)	1807.00	1771.00	1735.00	1681.00
241143	Dye Sublimation Kit	2038.00	1997.00	1956.00	1895.00

USD MSRP (C)

Product Size	Imprint Graphic Size	Dye Sub Graphic Size	Product Wt.
175.5"W x 119.25"-131.75"H x 118.25"D	Flat Peak: 44"W x 11.25"H Sloping Peak: 44"W x 24"H Valance: 60"W x 8"H	View Online Template	70.5 lbs.

10' x 20' Premium Gable Tent

Item #	Description	1	2-5	6-11	12-24
241170	Unimprinted Kit	1456.00	1427.00	1398.00	1354.00
241171	Full-Color Imprint Kit (1 Location)	1538.00	1507.00	1476.00	1430.00
241172	Full-Color Imprint Kit (2 Locations)	1620.00	1588.00	1555.00	1507.00
241174	Full-Color Imprint Kit (4 Locations)	1784.00	1748.00	1713.00	1659.00
241176	Full-Color Imprint Kit (6 Locations)	1961.00	1922.00	1883.00	1824.00
241178	Full-Color Imprint Kit (8 Locations)	2112.00	2070.00	2028.00	1964.00
241180	Full-Color Imprint Kit (10 Locations)	2288.00	2242.00	2196.00	2128.00
241182	Full-Color Imprint Kit (12 Locations)	2452.00	2403.00	2354.00	2280.00
241183	Dye Sublimation Kit	2651.00	2598.00	2545.00	2465.00

USD MSRP (C)

Product Size	Imprint Graphic Size	Dye Sub Graphic Size	Product Wt.
234.5"W x 119.25"-131.75"H x 118.25"D	Flat Peak: 44"W x 11.25"H Sloping Peak: 44"W x 24"H Valance: 60"W x 8"H	View Online Template	91.5 lbs.

UNIMPRINTED CANOPY LEAD TIME: SHIPS SAME DAY WHEN ORDERED BEFORE 2 PM CENTRAL

Shipping Case: Double-wall shipping box.

Prices are subject to change; visit our website for the most current pricing.
Setup fee: \$20.00(G).
See pages 208-211 for additional information that may apply to your order.

IMPRINT DYE SUB
AFTER FINAL PROOF APPROVAL
PRODUCTION LEAD TIME IS
4-7 DAYS



10' tent shown with UV printing



Choose Your Imprint Locations



One imprint per location (peak or valance).
Maximum of four locations per tent.
Only one setup fee per tent.

Kit Includes:



Soft Carry Case with Wheels



Stake Kit

10' ELITE TENT

The Elite tent features our strongest, most robust frame and adds a professional touch to any event.

- 2.125" diameter hexagon-shaped legs constructed of 1.55 mm anodized aluminum
- Machined aluminum joints
- Self-adjusting spring tension frame creates a taut, clean canopy peak
- Compatible with Tent Sandbag Ballasts (see page 109); not compatible with Square Plastic Water Weight and Steel Ballast Weight
- Canopy available in eight stock colors (see page 98), with full-bleed dye sublimation or with full-bleed UV printing



Easy-Glide Tent Feet allow the tent frame to slide on dirt and grass, preventing the legs from catching. US Patent #D760857



Legs feature levers for easy height adjustments.

10' Elite Tent

Item #	Description	1	2-5	6-11	12-24
240981	Full-Color Imprint Kit (1 Location)	1458.00	1429.00	1400.00	1356.00
240982	Full-Color Imprint Kit (2 Locations)	1540.00	1509.00	1478.00	1432.00
240984	Full-Color Imprint Kit (4 Locations)	1704.00	1670.00	1636.00	1585.00
240989	Dye Sublimation Kit	2187.00	2143.00	2100.00	2034.00
241423	UV-Printed Kit	2600.00	2548.00	2496.00	2418.00
		USD MSRP (C)			

Product Size	Imprint Graphic Size	Dye Sub / UV Graphic Size	Product Wt.
118"W x 116.75"H - 128.25"H x 118"D	Peak: 44"W x 24"H; Valance: 60"W x 8"H	View Online Template	78.5 lbs.

Shipping Case: Double-wall shipping box.

Prices are subject to change; visit our website for the most current pricing.
Setup fee: \$20.00(G).
See pages 208-211 for additional information that may apply to your order.

IMPRINT DYE SUB UV-PRINTED
AFTER FINAL PROOF APPROVAL
PRODUCTION LEAD TIME IS
4-7-10 DAYS

Kit Includes:



Soft Carry Case with Wheels



Stake Kit



10' TENT AND WALL KIT

This tent kit features everything you need for a full tent setup. Includes a frame, canopy, full wall and two half wall stabilizer bar kits for a three-sided marketing space.

- Available in 600 denier polyester
- Canopy and walls are printed with full-bleed dye sublimation
- Walls are single-sided and can be applied facing inward or outward



10' Standard tent and wall kit



Wall art will be printed on outward-facing side unless otherwise requested.

10' Tent and Wall Kit

Item #	Description	1	2-5	6-11	12-24
241400	10' Standard Dye Sublimation Kit	3130.00	3067.00	3005.00	2911.00
241401	10' Premium Dye Sublimation Kit	3432.00	3363.00	3295.00	3192.00

USD MSRP (C)

Description	Product Size	Dye Sub Graphic Size	Product Wt.
Standard	118.5"W x 127.5"-140"H x 118.5"D	View Online Template	66.2 lbs.
Premium	118"W x 126.75"-139.25"H x 118"D	View Online Template	60 lbs.

TENT ACCESSORIES



Item #240768 Heavy-duty tent stake kit

Tent Accessories

Item #	Description	Product Wt.	1	2-5	6-11	12-24
220079	10' Tent Soft Case with Wheels	5.8 lbs.	136.30	133.60	130.80	126.80
220150	10' or 15' Tent Hard Case with Wheels	22 lbs.	371.00	363.50	356.25	345.00
220080	15' or 20' Tent Soft Case with Wheels	8.2 lbs.	169.40	166.00	162.60	157.50
240768	Heavy-Duty Tent Stake Kit	5 lbs.	128.20	125.60	123.10	119.20
240085	Square Plastic Water Weight*	22 lbs. w/water	49.35	48.36	47.38	45.90
240094	Steel Ballast Weight*	11 lbs.	67.50	66.15	64.80	62.80
240112	Tent Sandbag Ballasts (Set of 4)	20.6 lbs. w/sand	74.20	72.70	71.25	69.00
240015	Tent Stake Kit	1 lb.	39.51	38.72	37.93	36.74

*Not Compatible with Elite Tent Frame USD MSRP (C)



Item #240015 Tent stake kit



Item #240094 Steel ballast weight



Item #240085 Square plastic water weight



Item #240112 Tent sandbag ballast



Item #220079 Soft case with wheels



Item #220150 Hard case with wheels

HARDWARE-ONLY LEAD TIME: SHIPS SAME DAY WHEN ORDERED BEFORE 2 PM CENTRAL

Prices are subject to change; visit our website for the most current pricing. Setup fee: \$20.00(G). See pages 208-211 for additional information that may apply to your order.

TENT KITS AFTER FINAL PROOF APPROVAL PRODUCTION LEAD TIME IS **7 DAYS**



TENT WALLS

With several creative options to choose from, you can customize your tent for a truly unique look.

- Available in 600 denier polyester
- Walls can be applied facing inward or outward
- Single-sided art will be printed on outward-facing side unless otherwise requested
- Tent frame and canopy sold separately
- Economy 10' tents are compatible with Deluxe half wall hardware



10' half wall kit with full-color imprint

HALF WALL STOCK COLORS

- Black
- White

15' walls available in white only



10' half wall kit with dye sublimation

5' Economy Tent Frame Half Wall Kits

Item #	Description	1	2-5	6-11	12-24
241314	5' Half Wall Kit (Unimprinted)	110.00	107.80	105.60	102.30
241315	5' Half Wall Kit (Full-Color Imprint)	150.00	147.00	144.00	139.50
241316	5' Half Wall Kit (Dye Sublimation)	325.00	318.50	312.00	302.25
241317	5' Double-Sided Half Wall Kit (Dye Sublimation)	425.00	416.50	408.00	395.25

Kit Includes: Half Wall, Stabilizing Bar and 2 Clamps USD MSRP (C)

Standard Tent Frame Half Wall Kits

Item #	Description	1	2-5	6-11	12-24
240336	10' Half Wall Kit (Unimprinted)	131.30	128.70	126.00	122.10
240339	10' Half Wall Kit (Full-Color Imprint)	212.30	208.10	203.80	197.40
240342	10' Half Wall Kit (Dye Sublimation)	235.50	230.80	226.10	219.00
240375	10' Double-Sided Half Wall Kit (Dye Sublimation)	426.50	418.00	409.50	396.75

Kit Includes: Half Wall, Stabilizing Bar and 2 Clamps USD MSRP (C)

Deluxe Tent Frame Half Wall Kits

Item #	Description	1	2-5	6-11	12-24
240856	6' Half Wall Kit (Dye Sublimation)	163.30	160.00	156.80	151.90
240857	6' Double-Sided Half Wall Kit (Dye Sublimation)	292.25	286.50	280.50	271.75
240886	8' Half Wall Kit (Dye Sublimation)	321.75	315.25	309.00	299.25
240887	8' Double-Sided Half Wall Kit (Dye Sublimation)	336.00	329.25	322.50	312.50
240337	10' Half Wall Kit (Unimprinted)	131.30	128.70	126.00	122.10
240340	10' Half Wall Kit (Full-Color Imprint)	212.30	208.10	203.80	197.40
240343	10' Half Wall Kit (Dye Sublimation)	235.50	230.80	226.10	219.00
240376	10' Double-Sided Half Wall Kit (Dye Sublimation)	426.50	418.00	409.50	396.75

Kit Includes: Half Wall, Stabilizing Bar and 2 Clamps USD MSRP (C)

Omni Tent Frame Half Wall Kits

Item #	Description	1	2-5	6-11	12-24
240306	10' Half Wall Kit (Unimprinted)	198.00	194.00	190.10	184.10
240307	10' Half Wall Kit (Full-Color Imprint)	320.50	314.00	307.75	298.00
240308	10' Half Wall Kit (Dye Sublimation)	618.50	606.00	594.00	575.00
240309	10' Double-Sided Half Wall Kit (Dye Sublimation)	790.00	774.00	758.50	734.50

Kit Includes: Half Wall and Stabilizing Bar USD MSRP (C)

90° Connector Clamp

Item #	Description	1	2-5	6-11	12-24
240192	Standard Frame Connector Clamp	13.62	13.35	13.08	12.67
240193	Deluxe Frame Connector Clamp	13.62	13.35	13.08	12.67
240194	Premium Frame Connector Clamp	13.62	13.35	13.08	12.67

USD MSRP (C)



Add-On

90° connector clamp connects two stabilizing bars to keep half walls at the same level.



UNIMPRINTED WALL AND CLAMP LEAD TIME: SHIPS SAME DAY WHEN ORDERED BEFORE 2 PM CENTRAL

IMPRINT DYE SUB
AFTER FINAL PROOF APPROVAL
PRODUCTION LEAD TIME IS
4-7 DAYS

Prices are subject to change; visit our website for the most current pricing.
Setup fee: \$20.00(G).
See pages 208-211 for additional information that may apply to your order.

Suggested Uses

State Fairs
Farmers Markets
Sport Arenas
Tailgating

Premium Tent Frame Half Wall Kits

Item #	Description	1	2-5	6-11	12-24
240338	10' Half Wall Kit (Unimprinted)	128.60	126.00	123.50	119.60
240341	10' Half Wall Kit (Full-Color Imprint)	209.80	205.60	201.40	195.10
240344	10' Half Wall Kit (Dye Sublimation)	232.80	228.10	223.50	216.50
240377	10' Double-Sided Half Wall Kit (Dye Sublimation)	424.00	415.50	407.00	394.25
240515	15' Half Wall Kit (Unimprinted)	156.30	153.20	150.00	145.40
240516	15' Half Wall Kit (Full-Color Imprint)	318.00	311.75	305.25	295.75
240517	15' Half Wall Kit (Dye Sublimation)	287.00	281.25	275.50	267.00

Kit Includes: Half Wall, Stabilizing Bar and 2 Clamps USD MSRP (C)

Elite Tent Frame Half Wall Kits

Item #	Description	1	2-5	6-11	12-24
240564	10' Half Wall Kit (Unimprinted)	138.60	135.80	133.10	128.90
240565	10' Half Wall Kit (Full-Color Imprint)	219.80	215.40	211.00	204.40
240566	10' Half Wall Kit (Dye Sublimation)	242.80	237.90	233.10	225.80
240567	10' Double-Sided Half Wall Kit (Dye Sublimation)	434.00	425.25	416.75	403.50

Kit Includes: Half Wall, Stabilizing Bar and 2 Clamps USD MSRP (C)

Description	Product Size	Graphic Size	Dye Sub Graphic Size	Product Wt. (Imprint / Dye Sub / Double-Sided)
5'	58.125"W x 38"H x 2.625"D	40"W x 24"H	View Online Template	2.4 lbs. / 2.6 lbs. / 3.6 lbs.
6'	72"W x 38"H x 2.25"D	NA	View Online Template	NA / 4.75 lbs. / 6.25 lbs.
8'	96"W x 38"H x 2.25"D	NA	View Online Template	NA / 5.25 lbs. / 7.25 lbs.
10'	Kit: 118"W x 38"H x 2.5"D	54"W x 24"H	View Online Template	4.75 lbs. / 5.25 lbs. / 7.25 lbs.
10' Elite	Kit: 118.5"W x 38"H x 3"D	54"W x 24"H	View Online Template	4.5 lbs. / 5 lbs. / 7 lbs.
10' Omni	Kit: 115.375"W x 38"H x 3"D	54"W x 24"H	View Online Template	4.5 lbs. / 8.25 lbs. / 10.25 lbs.
15'	Kit: 175.5"W x 38"H x 2.5"D	54"W x 24"H (2)	View Online Template	7.2 lbs. / 7.8 lbs. / NA

Full Tent Walls

Item #	Description	1	2-5	6-11	12-24
241318	5' Full Wall (Unimprinted)	155.00	151.90	148.80	144.20
241319	5' Full Wall (Full-Color Imprint)	260.00	254.75	249.50	241.75
241320	5' Full Wall (Dye Sublimation)	300.00	294.00	288.00	279.00
241321	5' Double-Sided Full Wall (Dye Sublimation)	470.00	460.50	451.25	437.00
240912	6' Full Wall (Unimprinted)	205.00	200.90	196.80	190.70
240913	6' Double-Sided Full Wall (Dye Sublimation)	432.50	423.75	415.25	402.25
240920	8' Full Wall (Dye Sublimation)	248.50	243.50	238.60	231.10
240921	8' Double-Sided Full Wall (Dye Sublimation)	571.00	559.50	548.00	531.00
240082	10' Full Wall (Unimprinted)	84.60	82.90	81.20	78.70
240083	10' Full Wall (Full-Color Imprint)	183.50	179.80	176.20	170.70
240084	10' Full Wall (Dye Sublimation)	346.50	339.50	332.75	322.25
240184	10' Double-Sided Full Wall (Dye Sublimation)	733.50	719.00	704.00	682.00
240396	15' Full Wall (Unimprinted)	153.30	150.20	147.20	142.60
240397	15' Full Wall (Full-Color Imprint)	275.25	269.75	264.25	256.00
240398	15' Full Wall (Dye Sublimation)	485.00	475.25	465.50	451.00
240348	15' Double-Sided Full Wall (Dye Sublimation)	951.00	932.00	913.00	884.50

USD MSRP (C)

Description	Product Size	Graphic Size	Dye Sub Graphic Size	Product Wt. (Imprint / Dye Sub / Double-Sided)
5'	57.25"W x 84.5"H	40"W x 30"H	View Online Template	1.7 lbs. / 2.2 lbs. / 5 lbs.
6'	71.75"W x 84.5"H	NA	View Online Template	NA / 3 lbs. / 6 lbs.
8'	98.75"W x 84.5"H	NA	View Online Template	NA / 3.5 lbs. / 7 lbs.
10'	118.25"W x 84.5"H	54"W x 30"H	View Online Template	3.4 lbs. / 4.4 lbs. / 10 lbs.
15'	176.75"W x 84.5"H	54"W x 30"H (2)	View Online Template	4.5 lbs. / 5.5 lbs. / 12.5 lbs.



TENTS

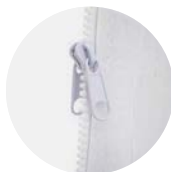

Heavy-duty double-pull zippers on the sides of full walls let you connect multiple walls together.

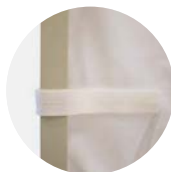

Walls attach to a tent frame using hook-and-loop straps.



UNIMPRINTED WALL LEAD TIME: SHIPS SAME DAY WHEN ORDERED BEFORE 2 PM CENTRAL

Prices are subject to change; visit our website for the most current pricing.
Setup fee: \$20.00(G).
See pages 208-211 for additional information that may apply to your order.

IMPRINT DYE SUB
AFTER FINAL PROOF APPROVAL
PRODUCTION LEAD TIME IS
4 OR 7 DAYS

GAMES & EVENTS

When choosing a game or event product
have you considered...

- **CONTEXT** - What kind of image are you trying to convey at your event?
- **LONGEVITY** - Do you plan to use the product more than once?
- **SIZE** - How large is your event space?
- **AUDIENCE** - How many people are you trying to accommodate?
- **WEATHER** - Will your event be indoors or outdoors?



Suggested Uses

- Carnivals
- Schools
- Trade Shows
- Sporting Events

SPIN 'N WIN PRIZE WHEEL

Give your next trade show or event a creative spin.

- Powder-coated steel legs
- A plastic clicker makes a ticking sound as the wheel spins
- Central disc panel attaches magnetically and remains stationary when the wheel spins
- All graphic panels can be custom printed with your design
- Includes twelve prize panels and central disc panel



Spin 'N Win Prize Wheel

Item #	Description	1	2-5	6-11	12-24
280104	Kit	711.50	697.50	690.00	676.00
Kit Includes: Hardware, Graphic Panels and Soft Carry Case		USD MSRP (C)			

Product Size	Finished Graphic Size	Product Wt.	Graphic Media
31.25"W x 40.75"-72"H x 16"-31"D	View Online Template	16.5 lbs.	Titan™ No-Curl Laminated Media



Prize wheel can be used on tabletops or as a standalone display with the legs extended.



Graphic panels and central disc panel can be printed using a desktop printer.

SELFIE FRAME

Photo ops have never been more fun! Selfie frames create real-world opportunities for truly viral social media campaigns.

- Constructed of 4 mm corrugated plastic
- Corrugated plastic is much stronger than cardboard, so the frame won't sag or flop
- Available single-sided only



36" x 46" size is scored in back so it can be folded for shipping, and it features clear tabs to hold it together.

Selfie Frame

Item #	Description	Product Wt.	1	2-5	6-11	12-24
271130	18"W x 24"H	0.25 lb.	18.12	17.76	17.58	17.21
271131	24"W x 36"H	0.5 lb.	27.31	26.76	26.49	25.94
271132	36"W x 46"H	1 lb.	47.82	46.86	46.39	45.43

USD MSRP (C)



36" x 46"

18" x 24"

Prices are subject to change; visit our website for the most current pricing.
Setup fee: \$20.00(G).
See pages 208-211 for additional information that may apply to your order.

PRIZE WHEEL | SELFIE
AFTER FINAL PROOF APPROVAL
PRODUCTION LEAD TIME IS
2 OR 3 DAYS



Custom Bean Bags

Bag Toss shown with Bag Toss Buddy (sold separately)

BAG TOSS GAME

Toss some friendly competition into your next event with this customizable game.

- Two game boards clasp together into a single unit that can be easily transported using the convenient carry handle
- Durable plastic construction prevents rust and splinters
- Included rope acts as a distance regulator
- Hinged legs fold out to prop the game boards up at an angle
- Bag Toss Buddy (sold separately) attaches to Bag Toss for access to a bag holder, score keeper and drink holder
- Personalize your bags with custom bean bags (sold separately)
- 90-day warranty on graphic panels; Bag Toss Buddy and Custom Printed Bean Bags have a 1-year warranty



Bag Toss Game

Item #	Description	1	2-5	6-11	12-24
280310	Kit	299.75	293.75	290.75	284.75
Kit Includes: Hardware, 8 Unimprinted Bean Bags and 2 Graphic Panels				USD MSRP (C)	

Product Size	Finished Graphic Size	Product Wt.	Media
Folded: 21.5"W x 2.75"H x 33.125"D (1) Open: 21.5"W x 10.5"H x 32.75"D	View Online Template	21.5 lbs.	Titan™ No-Curl Laminated Media

Add-Ons

Bag Toss Game Accessories

Item #	Description	1	2-5	6-11	12-24
280314	Bag Toss Buddy Kit	67.00	65.65	65.00	63.65
280315	Custom Bean Bags (Set of 8)	120.00	117.60	116.40	114.00
Bag Toss Buddy Kit Includes: 2 Scorekeepers and Drink Holders				USD MSRP (C)	
Custom Bean Bags: 8 Double-Sided Bean Bags (4 of Each Design)					



Built-in score keepers slide up and down the edges of the board.



Bean bags can be stored inside plastic molded pockets so they don't get left behind.



Bag Toss Buddy (sold separately) can be attached to folded Bag Toss for easy portability.

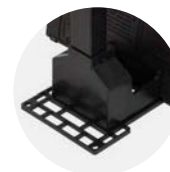

Bag Toss Buddy (sold separately) slides into the back of the Bag Toss for quick assembly.

BAG TOSS BEAN BAGS
AFTER FINAL PROOF APPROVAL
PRODUCTION LEAD TIME IS
3 OF 6 DAYS

HARDWARE-ONLY LEAD TIME: SHIPS SAME DAY WHEN ORDERED BEFORE 2 PM CENTRAL

Prices are subject to change; visit our website for the most current pricing.
Setup fee: \$20.00(G).
See pages 208-211 for additional information that may apply to your order.

Suggested Uses

Weddings
Fundraisers
Schools
Marathons

OUTDOOR EVENT COOLER

Keep drinks cold and your branding hot with this customizable cooler.

- Can be used indoors or outdoors
- Molded insulation keeps contents cold
- Clear lid lets you see what's inside
- Graphic is printed on Titan™ no-curl laminated media
- Holds up to 40 lbs. of ice and 48 standard 12 oz. cans



Outdoor Event Cooler

Item #	Description	1	2-5	6-11	12-24
280240	Kit	510.00	500.00	494.50	484.50
Kit Includes: Hardware and Installed Graphic Wrap		USD MSRP (C)			

Product Size	Finished Graphic Size	Product Wt.	Media
22.125"W x 35"H x 25.125"D	View Online Template	24.25 lbs.	Titan™ No-Curl Laminated Media



Drain cooler easily with spout located at base.



Single pivot lid can be opened and closed with one hand.



TRASHWORKS WRAP

A unique branding solution to cover drab trash cans and increase advertising at your next event.

- Provides a clean, polished, fitted look
- Artwork is vibrantly dye sublimated on two-way stretch fabric
- Stretches over the bottom and around the top rim of the trash can (trash can not included)
- Great for indoor and outdoor use
- Available in three sizes



TrashWorks Wrap

Item #	Description	Product Wt.	1	2-5	6-11	12-24
271140	32 Gallon	0.4 lb.	113.20	109.80	106.40	103.00
271141	44 Gallon	0.8 lb.	119.50	115.90	112.30	108.70
271142	55 Gallon	0.8 lb.	125.90	122.10	118.30	114.60
			USD MSRP (C)			

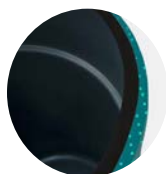

Simply place the graphic over the lip to secure to the trash can.



Graphic stretches over trash can to provide a unique branding opportunity.



Prices are subject to change; visit our website for the most current pricing.
Setup fee: \$20.00(G).
See pages 208-211 for additional information that may apply to your order.

AFTER FINAL PROOF APPROVAL
PRODUCTION LEAD TIME IS
4 DAYS



Break down your barricade and easily transport it in the included soft carry case.



EUROFIT BARRICADE

Turn your crowd-control barricade into an informational and advertisement opportunity!

- Artwork is dye sublimated on recycled polyester knit
- 100% recycled media is made with REPREEVE® fibers
- Graphic cover slips over the frame like a pillowcase
- Lightweight aluminum frame; wide feet for added stability
- Double-sided graphic cover is viewable from both the front and back of the display
- Ideal for indoor or short-term outdoor use
- Not compatible with EuroFit Connector or other EuroFit accessories



EuroFit Barricade

Item #	Description	1	2-5	6-11	12-24
263550	Kit	348.50	336.00	323.75	313.25

Kit Includes: Hardware, Graphic Cover and Soft Carry Case USD MSRP (C)

Product Size	Finished Graphic Size	Product Wt.	Media
80.875"W x 42.125"H x 14.125"D	View Online Template	12.4 lbs.	Recycled Polyester Knit



3' x 7'

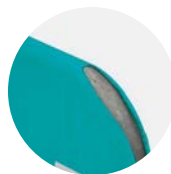

Covers are curved and open along the corners.



Hook-and-loop fasteners secure the cover.

BARRICADE COVER

Transform your event barricade into a prime advertising opportunity.

- Covers the full barricade (barricade not included)
- Maximize your impact by featuring a different design on each side
- Available in two-way stretch fabric (made in the USA) or Titan™ 18 oz. opaque scrim vinyl
- Custom sizes and other media options available (call for quote; restrictions may apply)
- Barricade Covers used outdoors have a 90-day warranty; Barricade Covers used indoors have a 1-year warranty



Barricade Cover

Item #	Description	Product Wt.	1	2-5	6-11	12-24
302090	3' x 7' Two-Way Stretch Fabric Cover	1.8 lbs.	314.75	305.25	295.75	286.50
302091	3' x 7' 18 oz. Opaque Scrim Vinyl Cover	3.8 lbs.	300.75	291.75	282.75	273.75
302092	3' x 8' Two-Way Stretch Fabric Cover	2.2 lbs.	327.00	317.25	307.50	297.50
302093	3' x 8' 18 oz. Opaque Scrim Vinyl Cover	4.4 lbs.	314.75	305.25	295.75	286.50
302094	3' x 10' Two-Way Stretch Fabric Cover	2.8 lbs.	342.50	332.25	322.00	311.75
302095	3' x 10' 18 oz. Opaque Scrim Vinyl Cover	5.4 lbs.	327.00	317.25	307.50	297.50

USD MSRP (C)

EUROFIT COVER
AFTER FINAL PROOF APPROVAL
PRODUCTION LEAD TIME IS
4-3 DAYS

Prices are subject to change; visit our website for the most current pricing.
Setup fee: \$20.00(G).
See pages 208-211 for additional information that may apply to your order.

BELT BARRIER

Perfect for controlling the flow and direction of customer queues.

- Sold in sets of 2
- Post made of durable stainless steel
- Available in black or chrome post with black tensioned belt
- Features 4 points of connection
- Deluxe is ideal for long-term use



Belt Barriers

Item #	Description	1	2-5	6-11	12-24
280140	Kit (Set of 2)	160.00	156.80	155.20	152.00
280146	Deluxe Kit (Set of 2)	200.00	196.00	194.00	190.00
Kit Includes: Black or Chrome Belt Barriers		USD MSRP (C)			

Description	Product Size	Product Wt.
Barrier	12.625"W x 36.5"H x 12.625"D	35.6 lbs.
Deluxe	14"W x 39.875"H x 14"D	47.25 lbs.



Deluxe Belt Barrier shown in chrome



Belt Barrier shown in black



When connecting to another barrier, the Belt Barrier belt extends up to 93" and the Deluxe belt extends up to 100".

WALL-MOUNT BELT BARRIER

Block off restricted areas or direct guests where they need to go.

- Available in black or chrome with black tensioned belt
- Includes drywall mounting kit and belt receiver clip
- Compatible with Belt Barrier and Deluxe Belt Barrier
- Wall-mount comes with belt catch; great for spanning hallways



chrome



black

Wall-Mount Belt Barrier

Item #	Description	1	2-5	6-11	12-24
280141	Kit	45.00	44.10	43.65	42.75
Kit Includes: Black or Chrome Wall-Mount Belt Barrier and Mounting Hardware		USD MSRP (C)			

Product Size	Product Wt.
4.5"W x 5.25"H x 3.625"D	1 lb.

The belt extends 117.5" from the hardware.

BELT BARRIER SIGN HOLDER

Add messaging to your belt barriers to guide and inform customers.

- Available in black or chrome
- Graphics are printed single-sided; two graphics and two clear plastic sheet protectors are included in kit
- Simply slides onto the top of the Belt Barrier or Deluxe Belt Barrier (sold separately)



Belt Barrier Sign Holder

Item #	Description	1	2-5	6-11	12-24
280142	Kit	87.00	85.25	84.40	82.65
Kit Includes: Black or Chrome Hardware and 2 Graphics (Belt Barriers Not Included)		USD MSRP (C)			

Product Size	Finished Graphic Size	Product Wt.	Media
9"W x 16.5"H x 3"D	7.75"W x 10"H	1.7 lbs.	Titan Polypropylene Media



Chrome Sign Holder shown with Deluxe Belt Barrier (sold separately)



HARDWARE-ONLY LEAD TIME: SHIPS SAME DAY WHEN ORDERED BEFORE 2 PM CENTRAL

Prices are subject to change; visit our website for the most current pricing.
Setup fee: \$20.00(G).
See pages 208-211 for additional information that may apply to your order.

AFTER FINAL PROOF APPROVAL
PRODUCTION LEAD TIME IS
2 DAYS

SIGNAGE

When choosing signage
have you considered...

- **LOCATION** - Will your sign be used indoors or outdoors?
- **LONGEVITY** - How long will your sign be displayed?
- **FLEXIBILITY** - Will your message be permanent or will it change frequently?
- **TRANSPORT** - Will your sign be stationary or will you be transporting it from place to place?



SIGNAGE COMPARISON CHART

BEST SELLERS ★ SUSTAINABLE ◆	OUTDOOR	PG #	EASY CHANGE GRAPHIC	SINGLE- OR DOUBLE-SIDED		SUBSTRATE	OUTDOOR		WIND RATING	WEIGHT
				SINGLE	DOUBLE		LONG TERM	SHORT TERM		
	NEW! Arch A-Frame	◆ 126	✓		X	Recycled Polyester Knit	X		2급	3.6 lbs.
	Coro A-Frame	◆ 126			X	4 mm Corrugated Plastic		X	1급	4 lbs.
	Corrugated Plastic Sign	★ ◆ 127		X	X	4 mm Corrugated Plastic	X		3급	0.5-1.5 lbs.
	Deluxe Wood A-Frame	121	✓		X	Chalkboard		X	2급	18-29.8 lbs.
	Economy Wood A-Frame	121	✓		X	Chalkboard		X	2급	8.5 lbs.
	NEW! EuroFit Flex Sign	◆ 128	✓		X	Recycled Polyester Knit	X		3급	14.8-15.7 lbs.
	NEW! EuroFit Swivel Sign	◆ 129	✓		X	Recycled Polyester Knit	X		4급	15-17.6 lbs.
	FrameWorx Flex	127	✓	X	X	Mesh Fabric		X	3급	27.5 lbs.
	Horizontal A-Frame	125	✓		X	Titan™ 13 oz. Scrim Vinyl	X		2급	11-18 lbs.
	Magnet Promo Sign	139		X		Magnet Media	X			0.4-1.6 lbs.
	Opaque Window Cling	139		X		Window Film	X			0.02-0.45 lb.
	Outdoor Flex Sign	128	✓		X	Titan™ 10 oz. Scrim Vinyl	X		3급	27 lbs.
	Outdoor Flex Sign with Ballast Base	128	✓		X	Titan™ 10 oz. Scrim Vinyl	X		3급	26 lbs.
	Outdoor Surface Tac	140		X		High-Tack Surface Film	X			0.4-3.8 lbs.
	Parking Pal	131			X	Reflective Media	X		4급	13 lbs.
	Rover Portable Sign Post	129	✓	X	X	Aluminum Composite	X		5급	11.4-18 lbs.
	Signicade A-Frame	★ 120	✓		X	4 mm Corrugated Plastic	X		4급	20 lbs.
	Signicade Deluxe A-Frame	★ 120	✓		X	4 mm Corrugated Plastic • Chalkboard	X		4급	21 -25 lbs.
	Simpo Sign II A-Frame	120	✓		X	4 mm Corrugated Plastic	X		4급	10.5 lbs.
	Storm Mat	★ 141		X		Polyester Carpeting with Rubber Backing	X			4-10 lbs.
	Sunrise Lawn Sign	130	✓	X	X	Super Poly Knit Fabric • Block-Out Polyester	X		3급	2.3 lbs.
	Sunrise Multisurface Sign	130	✓	X	X	Super Poly Knit Fabric • Block-Out Polyester	X		3급	13.5-14 lbs.
	Superstrong Angle Iron A-Frame	124	✓		X	4 mm Corrugated Plastic	X		3급	6.5-13.5 lbs.
	Swing A-frame	121	✓		X	Aluminum Composite • Chalkboard		X	2급	14-16.2 lbs.
	NEW! Twist-Up Oval A-Frame	◆ 125			X	Recycled Polyester Knit	X		2급	8.25 lbs.
	NEW! Wayfinding Sign	131			X	Aluminum Composite	X		6급	1.2 lbs.
	INDOOR	PG #		SINGLE	DOUBLE					
	NEW! Aerial SEG	◆ 136	✓		X	Recycled Polyester Knit				4.4-7.6 lbs.
	NEW! Aerial Glo SEG	136	✓		X	Backlit Woven Polyester				5-10.2 lbs.
	Crystal Edge Display	137	✓	X		Titan™ Backlit Media				5-13.7 lbs.
	Flat Base Sign Display	133	✓		X	4 mm Corrugated Plastic				13.5 lbs.
	Floor Decor	141		X		PVC Foam w/PVC Coated Polyester Woven Fabric				1.6-22 lbs.
	NEW! Floor Hugger Mat	141		X		Nylon Yarn with Rubber Backing				8-16 lbs.
	NEW! Galleria A-Frame	◆ 124	✓		X	Recycled Polyester Knit				6.8 lbs.
	NEW! Impress A-Frame	◆ 123	✓		X	Recycled Polyester Knit				9.4-10.8 lbs.
	NEW! Impress Lite A-Frame	◆ 123	✓		X	Recycled Polyester Knit				11 lbs.
	Indoor Surface Grip	140		X		Adhesive Matte Vinyl with Fabric Backing				0.05-2.4 lbs.
	LED Light Box	137	✓	X		Titan™ Backlit Media				8.5-14 lbs.
	Luxe Glo Sign	138		X		0.060 White Polycarbonate				3-6.6 lbs.
	NEW! Standard Glo Wall-Mount SEG	135	✓	X		Backlit Woven Polyester				2.8-12.4 lbs.
	NEW! Tower Trio	◆ 132			X	4 mm Corrugated Plastic				6-8 lbs.
	Uptown A-Frame	122	✓		X	Rigid PVC Board				15.5-24.25 lbs.
	Uptown Accent A-Frame	122	✓		X	Rigid PVC Board				30.5 lbs.
	NEW! Value Wall-Mount SEG	◆ 134	✓	X		Recycled Polyester Knit				2.2-6 lbs.
	NEW! Wayfinding Sign Post	133	✓		X	Aluminum Composite				13.6-15.2 lbs.

Beaufort Wind Rating: Select products have been rated on the Beaufort Wind Scale. Wind ratings were determined utilizing all available securing/stabilizing options sold with or offered for the product. Review the Beaufort Scale on page 211 for additional details.

SIGNAGE SUBSTRATES



RIGID

- 4 mm Corrugated Plastic
- Rigid PVC Board
- Chalkboard
- Aluminum Composite
- 0.060 White Polycarbonate

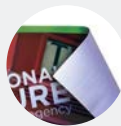

BANNER

- Titan™ 10 oz. Scrim Vinyl
- Titan™ 13 oz. Scrim Vinyl
- Titan™ Backlit Media

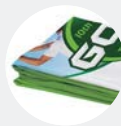

FABRIC

- Super Poly Knit Fabric
- Recycled Polyester Knit
- Mesh Fabric
- Backlit Woven Polyester
- Block-Out Polyester



MAT

- PVC Foam w/PVC Coated Polyester Woven Fabric
- Nylon Yarn with Rubber Backing
- Polyester Carpeting with Rubber Backing

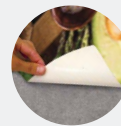

DECAL

- Adhesive Matte Vinyl with Fabric Backing
- High-Tack Surface Film
- Window Cling
- Magnet Media
- Reflective Media



Signicade Deluxe

Signicade Deluxe Chalkboard

Simpo Sign II

Signicade

SIGNICADE® AND SIMPO A-FRAMES

With multiple sizes to choose from, these A-frames fit a variety of spaces.

- Maintenance-free and weather-resistant
- Folds flat for easy transport or storage
- Signicade Deluxe available with signboards or chalkboard inserts
- Chalkboard inserts can be printed on for custom messaging



Chalk or chalk markers work in unprinted areas only (chalk markers recommended; not included).

Simpo Sign II A-Frame

Item #	Description	1	2-5	6-11	12-24
210091	Single-Sided Kit	229.80	222.70	212.40	207.10
271049	Single-Sided Signboard Only (1)	27.31	26.49	25.67	24.85
210092	Double-Sided Kit	246.40	239.30	228.00	222.70
271050	Double-Sided Signboard Only (1)	35.87	34.79	33.72	32.64

Kit Includes: Hardware and 2 Single- or Double-Sided Graphics USD MSRP (C)

Product Size	Finished Graphic Size	Product Wt.	Media
24"W x 36.75"H x 21.5"D	22"W x 28"H	10.5 lbs.	4 mm Corrugated Plastic

FRAME COLOR White

One Signboard, Two Sides.

Double-sided signboards have your artwork printed on both sides, making each signboard reversible.



Double-sided signboards available for Simpo Sign II and Signicade Deluxe

Signicade Deluxe A-Frame

Item #	Description	1	2-5	6-11	12-24
210121	Single-Sided Kit	238.00	230.60	219.90	214.40
271072	Single-Sided Signboard Only (1)	27.31	26.49	25.67	24.85
210122	Double-Sided Kit	254.50	247.25	235.50	230.00
271073	Double-Sided Signboard Only (1)	35.87	34.79	33.72	32.64
264310	Imprinted Single-Sided Chalkboard Kit	361.75	349.00	336.50	325.50
264312	Imprinted Single-Sided Chalkboard Only (1)	88.40	85.75	83.10	80.45
210280	Unimprinted Chalkboard Kit	301.00	293.50	277.75	272.25
271098	Unimprinted Chalkboard Only (1)	60.40	58.00	55.55	53.75

Kit Includes: Black or White Hardware and 2 Unimprinted, Single- or Double-Sided Graphics USD MSRP (C)

Product Size	Finished Graphic Size	Product Wt. (Coro / Chalkboard)	Media
27"W x 38.5"H x 19"D	24"W x 36"H	21 lbs. / 25 lbs.	4 mm Corrugated Plastic Chalkboard Laminated Rigid PVC Board

FRAME COLORS Black White

Signicade A-Frame

Item #	Description	1	2-5	6-11	12-24
210133	Kit	216.60	210.10	200.20	195.30
271084	Single-Sided Signboard Only (1)	27.31	26.49	25.67	24.85

Kit Includes: Orange, Yellow or White Hardware, 2 Single-Sided Graphics, 2 Strips of Hook and 2 Strips of Loop USD MSRP (C)

Product Size	Finished Graphic Size	Product Wt.	Media
24.5"W x 42"H x 31"D	24"W x 36"H	20 lbs.	4 mm Corrugated Plastic

FRAME COLORS Orange Yellow White

Features & Benefits



Plastic base won't rust, making it great for outdoor use.



Convenient molded handle makes it easy to move.



Frames can be filled with water or sand for stability. (Sand only for Simpo II).



Signboards are easy to swap out to accommodate frequent message changes.

AFTER FINAL PROOF APPROVAL
PRODUCTION LEAD TIME IS
2DAYS

UNIMPRINTED CHALKBOARD ONLY LEAD TIME: SHIPS SAME DAY WHEN ORDERED BEFORE 2 PM CENTRAL

Prices are subject to change; visit our website for the most current pricing.
Setup fee: \$20.00(G).
See pages 208-211 for additional information that may apply to your order.

DELUXE AND ECONOMY WOOD A-FRAMES

These A-frames give you an upscale way to display daily specials, menu items, messages and creative artwork.

- Available in two colors; Deluxe is also available in two sizes
- Print artwork directly onto chalkboard to enhance your custom message
- Recommended for indoor or limited outdoor use
- Economy frame is made from pine wood; Deluxe frame is made from beech wood
- Wood A-frames used outdoors have a 30-day warranty;
- wood A-frames used indoors have a 1-year warranty



Deluxe Wood Chalkboard A-Frame

Item #	Description	1	2-5	6-11	12-24
263520	32.5" Kit	231.50	225.50	214.40	209.90
263523	46" Kit	319.00	310.75	295.50	289.25

Kit Includes: Espresso or Light Brown Hardware and 2 Installed Single-Sided Graphics USD MSRP (C)

Description	Product Size	Finished Graphic Size	Product Wt.	Media
32.5"	21.625"W x 32.5"H x 19.125"D	18.25"W x 25.25"H	17.8 lbs.	Chalkboard
46"	26.75"W x 46"H x 24.375"D	23.5"W x 39.5"H	29.8 lbs.	Chalkboard

Economy Wood Chalkboard A-Frame

Item #	Description	1	2-5	6-11	12-24
263530	Kit	195.10	190.50	180.90	177.50

Kit Includes: Espresso or Light Brown Hardware and 2 Installed Single-Sided Graphics USD MSRP (C)

Product Size	Finished Graphic Size	Product Wt.	Media
21.625"W x 32.5"H x 18.5"D	18.25"W x 25.25"H	8.4 lbs.	Chalkboard



Deluxe 46" shown in light brown

Economy shown in espresso

Chalkboard inserts are constructed of polypropylene.



A steel chain prevents the A-frame from opening all the way so it remains stable.



Metal hinges let you fold the frame flat for easy storage.



Imprinted chalkboard inserts slide into grooves in the top of the frame.

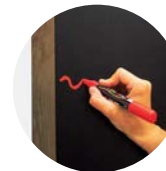

Chalk or chalk markers work in unimprinted areas only (chalk markers recommended; not included).

SWING A-FRAME

Attract business with this eye-catching swinging A-frame.

- Modern frame constructed of black steel
- Included clips make it easy to attach the sign to the top of the frame
- Artwork is printed on double-sided chalkboard or aluminum composite; blank chalkboard is also available
- Recommended for indoor and limited outdoor use
- Hex wrench included



Swing A-Frame

Item #	Description	1	2-5	6-11	12-24
263543	Aluminum Composite Kit	390.00	376.00	362.00	350.25
263540	Imprinted Chalkboard Kit	338.00	325.50	313.00	303.00
263541	Unimprinted Chalkboard* Kit	280.75	269.50	258.25	250.00

Kit Includes: Hardware and Double-Sided Graphic
*Unimprinted chalkboard is blank USD MSRP (C)

Description	Product Size	Finished Graphic Size	Product Wt.	Media
Aluminum	22.5"W x 37.625"H x 27.5"D	20"W x 30"H	14 lbs.	Aluminum Composite
Chalkboard	22.5"W x 37.625"H x 27.5"D	20"W x 30"H	16.2 lbs.	Chalkboard

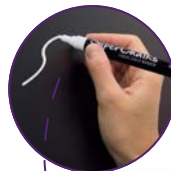

Chalk or chalk markers work in unimprinted areas only (chalk markers recommended; not included).



Aluminum composite

Imprinted Chalkboard

UNIMPRINTED CHALKBOARD ONLY LEAD TIME: SHIPS SAME DAY WHEN ORDERED BEFORE 2 PM CENTRAL

Prices are subject to change; visit our website for the most current pricing.
Setup fee: \$20.00(G).
See pages 208-211 for additional information that may apply to your order.

WOOD | SWING
AFTER FINAL PROOF APPROVAL
PRODUCTION LEAD TIME IS
2 & 3 DAYS



UPTOWN A-FRAME

This A-frame presents your message with a touch of class.

- Recommended for indoor use
- Artwork is printed on durable rigid PVC board
- Frame constructed of high-grade aluminum with a silver matte finish
- Foot pegs prevent the A-frame from scratching floors or slipping



Uptown A-Frame

Item #	Description	1	2-5	6-11	12-24
263190	40" Kit	338.75	328.50	313.50	305.75
263192	45" Kit	373.75	362.75	346.00	337.50
Kit Includes: Hardware, 2 Single-Sided Graphics and 1 Double-Sided Rider Graphic Panel				USD MSRP (C)	

Description	Product Size	Finished Graphic Size	Product Wt.	Media
40"	18.75"W x 40.875"H x 29"D	Signboard: 16.5"W x 23.375"H Rider Panel: 18.2"W x 7"H	15.5 lbs.	Rigid PVC Board
45"	26.625"W x 45.375"H x 32.625"D	Signboard: 23.375"W x 33"H Rider Panel: 25.1"W x 7"H	24.25 lbs.	Rigid PVC Board



Edges flip open so swapping out signboards is easy.



Rider panel simply slides into a slot in the top of the frame.

Suggested Uses

Movie Theaters
Charity Events
Malls
Clinics



Accent panel slides into a slot on the side of the frame.

Edges flip open so swapping out signboards is easy.



Rider panel simply slides into a slot in the top of the frame.

UPTOWN ACCENT A-FRAME

With so many ways to display, the Uptown Accent is an impressively versatile A-frame.

- Recommended for indoor use
- Artwork is printed on durable rigid PVC board
- Frame constructed of high-grade aluminum with a silver matte finish
- Foot pegs prevent the A-frame from scratching floors or slipping



Uptown Accent A-Frame

Item #	Description	1	2-5	6-11	12-24
263196	Kit	406.75	395.25	376.75	368.25
Kit Includes: Hardware, 2 Single-Sided Graphics, 2 Single-Sided Accent Graphic Panels and 1 Double-Sided Rider Graphic Panel				USD MSRP (C)	

Product Size	Finished Graphic Size	Product Wt.	Media
25.625"W x 50.875"H x 35.75"D	Signboard: 23.375"W x 33"H Accent Panel: 25.25"W x 8.25"H Rider Panel: 25.1"W x 7"H	30.5 lbs.	Rigid PVC Board

AFTER FINAL PROOF APPROVAL
PRODUCTION LEAD TIME IS
2DAYS

Prices are subject to change; visit our website for the most current pricing.
Setup fee: \$20.00(G).
See pages 208-211 for additional information that may apply to your order.

IMPRESS A-FRAME

The sleek look of SEG combined with the convenience of an A-frame.

- Includes two easy-to-install single-sided graphic panels that create a two-sided display
- Artwork is vibrantly dye sublimated on recycled polyester knit
- 100% recycled media is made with REPREVE® fibers
- SEG provides a modern, frameless look
- Portable aluminum frame with a strong, sturdy, steel base
- Indoor use only



Impress A-Frame

Item #	Description	1	2-5	6-11	12-24
264300	36" Kit	333.50	321.00	308.75	298.75
264303	42" Kit	371.00	357.25	343.50	332.50

Kit Includes: Hardware and 2 Graphic Panels USD MSRP (C)

Description	Product Size	Finished Graphic Size	Product Wt.	Media
36"	23.25"W x 36.375"H x 25.125"D	View Online Template	9.4 lbs.	Recycled Polyester Knit
42"	27.5"W x 42.75"H x 26.5"D	View Online Template	10.8 lbs.	Recycled Polyester Knit



SEG graphics provide a frameless appearance.



Pull tab lets you quickly remove SEG panel from the frame.



IMPRESS LITE A-FRAME

This lightweight and compact A-frame is destined to impress.

- A-frame includes two easy-to-install single-sided graphic panels to create a two-sided display
- Artwork is vibrantly dye sublimated on recycled polyester knit
- 100% recycled media is made with REPREVE® fibers
- SEG provides a modern, frameless look
- Lightweight aluminum frame
- Indoor use only



Impress Lite A-Frame

Item #	Description	1	2-5	6-11	12-24
264315	Kit	280.00	270.00	260.25	251.75

Kit Includes: Hardware and 2 Graphic Panels USD MSRP (C)

Product Size	Finished Graphic Size	Product Wt.	Media
23.375"W x 43.75"H x 32"D	View Online Template	11 lbs.	Recycled Polyester Knit

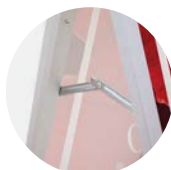

Side hinges secure the display when in use.



Pull tab lets you quickly remove SEG panel from the frame.



With a quick press of your thumb, the fabric's gasket edges are pushed into narrow channels built into the frame.



Sustainable recycled polyester knit is made with REPREVE® fibers recycled from plastic bottles.



Prices are subject to change; visit our website for the most current pricing.
Setup fee: \$20.00(G).
See pages 208-211 for additional information that may apply to your order.

AFTER FINAL PROOF APPROVAL
PRODUCTION LEAD TIME IS
4 DAYS



NEW PRODUCT

NEW RECYCLED POLYESTER KNIT

GALLERIA A-FRAME

This A-frame impresses passersby with the upscale look of fabric. The lightweight frame makes this easy to move around, and the graphic can be swapped out easily to keep your messaging fresh.

- Graphic panel wraps around the top to create a double-sided display
- Artwork is dye sublimated on recycled polyester knit
- 100% recycled media is made with REPREVE® fibers
- Push-button connectors for easy assembly
- Indoor use only
- Includes a drawstring pouch for easy transport



Galleria A-Frame

Patent Pending

Item #	Description	1	2-5	6-11	12-24
263570	Kit	330.00	317.50	305.00	295.25
Kit Includes: Hardware, Graphic Panel and Drawstring Pouch				USD MSRP (C)	

Product Size	Finished Graphic Size	Product Wt.	Media
27.25"W x 41.5"H x 27.5"D	View Online Template	6.8 lbs.	Recycled Polyester Knit



Graphic has sewn in loop fasteners.



Lightweight aluminum frame that is similar to our EuroFit line.



Graphic attaches to the frame with hook-and-loop for easy installation.



Fasteners are included with 24" x 36" hardware.



24" x 18" hardware has tabs on the sides to hold the signboard in place.

SUPERSTRONG ANGLE IRON A-FRAME

Constructed of iron, this is the strongest A-frame we offer.

- Durable iron frame with black powder-coated finish
- Artwork is printed single-sided on 4 mm corrugated plastic
- Accepts rigid substrates such as aluminum composite and corrugated plastic up to 0.25" thick
- Great for outdoor use



Superstrong Angle Iron A-Frame

Item #	Description	1	2-5	6-11	12-24
381014	24" x 18" Kit	112.40	109.30	104.00	101.70
271078	24" x 18" Signboard Only (1)	18.12	17.58	17.03	16.49
381012	24" x 36" Kit	142.20	138.60	131.80	129.10
271079	24" x 36" Signboard Only (1)	27.31	26.49	25.67	24.85
Kit Includes: Hardware and 2 Single-Sided Graphics				USD MSRP (C)	

Description	Product Size	Finished Graphic Size	Product Wt.	Media
24" x 18"	24.5"W x 25"H x 24"D	23.875"W x 17.875"H	6.5 lbs.	4 mm Corrugated Plastic
24" x 36"	24.25"W x 40.5"H x 25"D	23.875"W x 35.875"H	13.5 lbs.	4 mm Corrugated Plastic

GALLERIA SUPERSTRONG
AFTER FINAL PROOF APPROVAL
PRODUCTION LEAD TIME IS
4 or 2 DAYS

Prices are subject to change; visit our website for the most current pricing.
Setup fee: \$20.00(G).
See pages 208-211 for additional information that may apply to your order.

HORIZONTAL A-FRAME

This aluminum A-frame is built to handle outdoor conditions.

- Lightweight and portable
- Artwork is printed on Titan™ 13 oz. scrim vinyl
- Banners used outdoors have a 90-day warranty; banners used indoors have a 1-year warranty



Horizontal A-Frame

Item #	Description	1	2-5	6-11	12-24
210109	4' Kit	377.50	366.25	351.00	339.75
210107	8' Kit	591.50	574.00	550.00	532.50

Kit Includes: Hardware, Stakes, Bungee Cords, 2 Single-Sided Graphics and Soft Carry Case USD MSRP (C)

Description	Product Size	Finished Graphic Size	Product Wt.	Media
4'	51"W x 38"H x 24.75"D	46"W x 33"H	11 lbs.	Titan™ 13 oz. Scrim Vinyl
8'	100.75"W x 38"H x 24.75"D	94"W x 33"H	18 lbs.	Titan™ 13 oz. Scrim Vinyl



Bungee cords attach to grommets on the banner, so swapping out banners is easy.



Included stakes help keep the A-frame anchored.



SIGNAGE

TWIST-UP OVAL A-FRAME

This display twists in on itself, collapsing into a highly compacted, extremely portable unit.

- Artwork is dye sublimated on recycled polyester knit
- 100% recycled media is made with REPREVE® fibers
- Different artwork can be used on each side
- Four ground stakes included to secure the display
- The carry case features a pouch for the ground stakes
- Graphic covers used outdoors have a 90-day warranty; graphic covers used indoors have a 1-year warranty



Twist-Up Oval A-Frame

Item #	Description	1	2-5	6-11	12-24
210318	Kit	402.75	390.75	374.50	362.50

Kit Includes: Hardware, 4 Stakes, 2 Single-Sided Installed Graphic Covers and Soft Carry Case USD MSRP (C)

Product Size	Finished Graphic Size	Product Wt.	Media
80.25"W x 33.5"H x 23"D	View Online Template	8.25 lbs.	Recycled Polyester Knit



Twists down to a 34" diameter circle that fits neatly into the included carry case.



The display features grommets so it can be tethered to the ground using included stakes.

Prices are subject to change; visit our website for the most current pricing.
Setup fee: \$20.00(G).
See pages 208-211 for additional information that may apply to your order.

HORIZONTAL | TWIST-UP
AFTER FINAL PROOF APPROVAL
PRODUCTION LEAD TIME IS
2 or 5 DAYS



The display features grommets so it can be tethered to the ground using included stakes.



Soft carry case



Suggested Uses

Coffee Shops
Cafes
Sidewalk Sales
Sport Arenas

ARCH A-FRAME

Gear up your outdoor events with this lightweight and portable A-frame display.

- Artwork is dye sublimated on recycled polyester knit
- 100% recycled media is made with REPREVE® fibers
- Different artwork can be used on each side
- Four ground stakes included to secure the display
- Display can be disassembled to fit into the included carry case
- Graphic covers used outdoors have a 90-day warranty; graphic covers used indoors have a 1-year warranty



Arch A-Frame

Item #	Description	1	2-5	6-11	12-24
210325	Kit	258.00	249.50	241.00	233.25
Kit Includes: Hardware, 4 Stakes, 2 Single-Sided Graphic Covers and Soft Carry Case		USD MSRP (C)			
Product Size	Finished Graphic Size	Product Wt.	Media		
79.5"W x 30"H x 13.5"D	77"W x 26"H	3.6 lbs.	Recycled Polyester Knit		



CORO A-FRAME

Our lightest A-frame gives you a simple, inexpensive way to promote your message.

- Sold in sets of two
- Artwork is printed single-sided on 4 mm corrugated plastic
- A-frame is folded into an A shape; different artwork can be used on each side
- Bottom sections overlap for a stable base
- Folds flat for easy transport and storage
- Tool-free assembly
- Corrugated plastic can be recycled after use



Coro A-Frame

Item #	Description	1	2-5	6-11	12-24
271125	Kit (Set of 2)	94.40	91.55	88.75	85.90
Kit Includes: 2 A-frame Imprinted Signs		USD MSRP (C)			
Product Size	Finished Graphic Size	Product Wt.	Media		
22"W x 35.5"H x 12"D	22"W x 36"H	4 lbs.	4 mm Corrugated Plastic		



Multiply your message with a set of two A-frames.



Pair with a tent weight for outdoor use (sold separately; see page 109).

ARCH | CORO
AFTER FINAL PROOF APPROVAL
PRODUCTION LEAD TIME IS
4 OF 2 DAYS

Prices are subject to change; visit our website for the most current pricing.
Setup fee: \$20.00(G).
See pages 208-211 for additional information that may apply to your order.

CORRUGATED PLASTIC SIGN

Great for use on lawns, this sign gives you a simple, inexpensive way to get your message noticed.

- Constructed of 4 mm corrugated plastic
- Full-color artwork can be printed on one or both sides
- Custom sizes and shapes available (call for quote; restrictions may apply)
- Corrugated plastic can be recycled after use



Corrugated Plastic Sign

Item #	Description	1	2-5	6-11	12-24
271109	36"W x 24"H Unimprinted	8.30	8.05	7.80	7.55
271110	36"W x 24"H Single-Sided	27.30	26.48	25.66	24.84
271111	36"W x 24"H Double-Sided	35.85	34.77	33.70	32.62
271112	24"W x 18"H Unimprinted	4.90	4.75	4.61	4.46
271113	24"W x 18"H Single-Sided	18.10	17.56	17.01	16.47
271114	24"W x 18"H Double-Sided	23.65	22.94	22.23	21.52

USD MSRP (C)

Corrugated Plastic Sign Kit

Item #	Description	1	2-5	6-11	12-24
271133	36"W x 24"H Unimprinted Kit	11.10	10.85	10.60	10.29
271134	36"W x 24"H Single-Sided Kit	30.10	29.28	28.46	27.58
271135	36"W x 24"H Double-Sided Kit	38.65	37.57	36.50	35.36
271136	24"W x 18"H Unimprinted Kit	7.70	7.55	7.41	7.20
271137	24"W x 18"H Single-Sided Kit	20.90	20.36	19.81	19.21
271138	24"W x 18"H Double-Sided Kit	26.45	25.74	25.03	24.26

Kit Includes: Standard Step Stake and Unimprinted, Single- or Double-Sided Graphic
USD MSRP (C)

STANDARD STEP STAKE

- Installation is quick and easy

Standard Step Stake

Item #	Description	1-10	11-20	21-30	31+
381501	Standard Step Stake	2.80	2.74	2.66	2.60

USD MSRP (C)

FRAMEWORX FLEX

Our popular FrameWorx display is fitted with a mesh fabric banner and ballast to be used outdoors.

- Designed for short-term outdoor use
- Banner features clear plastic grommets
- Artwork is dye sublimated on mesh fabric
- Wheels on the base make it easy to move
- Base holds 8 gallons of water; weighs 76.6 lbs. when filled
- Tool-free assembly
- Banners used outdoors have a 90-day warranty; banners used indoors have a 1-year warranty



FrameWorx Flex

Item #	Description	1	2-5	6-11	12-24
210342	Single-Banner Kit	630.50	605.50	586.50	554.50
210343	Double-Banner Kit	789.00	771.00	729.50	706.50

Kit Includes: Hardware, Single-Sided Graphic(s) and Soft Carry Case
USD MSRP (C)

Product Size	Finished Graphic Size	Product Wt. (Single / Double)	Media
41.25"W x 98.875"H x 21.5"D	View Online Template	27 lbs. / 275 lbs.	Mesh Fabric



Tension corner springs keep the banner centered and taut.

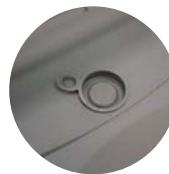

Plastic ballast base can be filled with water or sand.



HARDWARE-ONLY LEAD TIME: SHIPS SAME DAY WHEN ORDERED BEFORE 2 PM CENTRAL

Prices are subject to change; visit our website for the most current pricing.
Setup fee: \$20.00(G).
See pages 208-211 for additional information that may apply to your order.

CORO FRAMEWORX
24 DAYS
AFTER FINAL PROOF APPROVAL
PRODUCTION LEAD TIME IS



Custom shapes available online in four sizes of 4 mm corrugated plastic. Approved custom sizes and shapes are produced with a 1/2" white border. Call your rep for more details. Step stake sold separately.

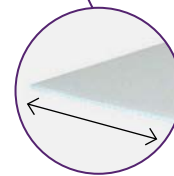

Stakes slide into fluted openings along the width of the signboard.



Flex Sign



Flex Sign with Ballast Base



Edges flip open for easy poster changes.



Spring-mounted base allows sign to gently flex in the wind.



Wheels on the ballast base make it easy to move.



Ballast base can be filled with water or sand for stability.

OUTDOOR FLEX SIGN

This spring-mounted sign is built to withstand the elements.

- Each poster is protected behind a sheet of clear, non-glare acrylic
- Graphics are printed single-sided; two graphics included in kit
- Ballast base holds 4.5 gallons of water; weighs 63 lbs. when filled
- Tool-free assembly



Outdoor Flex Sign

Item #	Description	1	2-5	6-11	12-24
210127	Flex Sign Kit	453.25	439.75	421.50	408.00
263006	Flex Sign with Ballast Base Kit	497.25	482.25	462.50	447.50
Kit Includes: Hardware, 2 Protective Acrylic Sheets and 2 Single-Sided Graphics				USD MSRP (C)	

Description	Product Size	Finished Graphic Size	Product Wt.	Media
Flex Sign	25.5"W x 44"H x 29"D	23.4375"W x 33.125"H	27 lbs.	Titan™ 10 oz. Scrim Vinyl
Flex Sign w/Ballast Base	31"W x 46"H x 20"D	23.4375"W x 33.125"H	26 lbs.	Titan™ 10 oz. Scrim Vinyl



90"



50"

NEW
RECYCLED
POLYESTER
KNIT

EUROFIT FLEX SIGN

Our wildly popular EuroFit display Size combined with a flexible ballast base adds motion to your message.

- Available in two sizes
- Artwork is printed on recycled polyester knit
- 100% recycled media is made with REPREVE® fibers
- Easy assembly with lightweight aluminum push-button poles
- Ballast base holds 4 gallons of water; weighs 45.4 lbs. when filled
- Banners used outdoors have a 90-day warranty; banners used indoors have a 1-year warranty



EuroFit Flex Sign

Item #	Description	1	2-5	6-11	12-24
263560	50"H Kit	470.00	452.50	434.75	420.75
263561	90"H Kit	580.00	558.50	537.00	520.00
Kit Includes: Hardware and Graphic Cover				USD MSRP (C)	

Description	Product Size	Finished Graphic Size	Product Wt.	Media
50"H	26.5"W x 48"H x 23.375"D	View Online Template	14.8 lbs.	Recycled Polyester Knit
90"H	26.5"W x 87.25"H x 23.375"D	View Online Template	15.7 lbs.	Recycled Polyester Knit



Spring-mounted base allows sign to gently flex in the wind.



Ballast base can be filled with water or sand for stability; wheels make it easy to move.

OUTDOOR EUROFIT
AFTER FINAL PROOF APPROVAL
PRODUCTION LEAD TIME IS
24 DAYS

Prices are subject to change; visit our website for the most current pricing.
Setup fee: \$20.00(G).

See pages 208-211 for additional information that may apply to your order.

EUROFIT SWIVEL SIGN

A touch of swivel brings an element of life to your display.

- Available in three shapes: round, short and tall rectangle
- Artwork is vibrantly dye sublimated on recycled polyester knit
- 100% recycled media is made with REPREVE® fibers
- Double-sided graphic cover zips closed around aluminum frame
- Swivel base allows graphic to move with the breeze
- Ballast base holds 6.11 gallons of water; weighs 60.7 lbs. when filled
- Optional Base Graphic available (sold separately)
- Graphic covers used outdoors have a 90-day warranty; graphic covers used indoors have a 1-year warranty



EuroFit Swivel Sign

Item #	Description	1	2-5	6-11	12-24
258070	Round Kit	471.75	454.75	437.75	423.50
258073	Short Rectangle Kit	377.75	363.75	349.75	338.50
258076	Tall Rectangle Kit	440.25	424.25	408.00	394.75

Kit Includes: Hardware and Graphic Cover USD MSRP (C)

Description	Product Size	Finished Graphic Size	Product Wt.	Media
Round	55"W x 66.5"H x 24.75"D	View Online Template	16.2 lbs.	Recycled Polyester Knit
Short	33.375"W x 58.5"H x 24.75"D	View Online Template	15 lbs.	Recycled Polyester Knit
Tall	33.25"W x 89.75"H x 24.75"D	View Online Template	17.6 lbs.	Recycled Polyester Knit
Base		View Online Template	0.6 lb.	Recycled Polyester Knit

Add-On



Optional Base Graphic

Item #	Description	1	2-5	6-11	12-24
258079	Base Graphic	75.50	73.25	70.95	68.70

USD MSRP (C)



Short Rectangle

Round shown with optional Base Graphic

Tall Rectangle

ROVER PORTABLE SIGN POST

The best addition to your curbside or parking lot directs your customers where they need to be.

- Artwork is UV-printed on aluminum composite
- Square post attaches flush to sign
- Sign is printed single-sided; double-sided kits include two signs
- 60" base can be filled with 60-80 lbs. of silica sand for additional stability; 72" base can be filled with 150-180 lbs.
- Wrench needed for assembly (not included)



Rover Portable Sign Post

Item #	Description	1	2-5	6-11	12-24
264500	60" Single-Sided Kit	234.00	225.10	216.00	209.10
264501	60" Double-Sided Kit	269.50	261.75	249.25	243.50
264505	72" Single-Sided Kit	302.00	290.50	278.75	269.75
264506	72" Double-Sided Kit	343.50	333.25	317.50	309.75

Single-Sided Kit Includes: Hardware and Single-Sided Graphic USD MSRP (C)
 Double-Sided Kit Includes: Hardware and 2 Single-Sided Graphics

Description	Product Size	Finished Graphic Size	Product Wt. (Single / Double)	Media
60"	18.2"W x 63.7"H x 19.5"D	View Online Template	11.4 lbs. / 12.4 lbs.	Aluminum Composite
72"	23.35"W x 77"H x 25.5"D	View Online Template	16 lbs. / 18 lbs.	Aluminum Composite



Secure base and sign(s) with included hardware.



Strong plastic post is reinforced with center cross bars.



Relocate sign easily with durable wheeled plastic base.



60" single-sided kit

72" double-sided kit

Prices are subject to change; visit our website for the most current pricing.
 Setup fee: \$20.00(G).
 See pages 208-211 for additional information that may apply to your order.

SWIVEL ROVER
 AFTER FINAL PROOF APPROVAL
 PRODUCTION LEAD TIME IS
4 or 3 DAYS



SUNRISE LAWN SIGN

Silhouetted like the rising sun, this lightweight variation on our popular sail signs is perfect for frequent outdoor use.

- Artwork is dye sublimated on super poly knit fabric for single-sided banners and on block-out polyester for double-sided banners
- Flexible fiberglass poles can be used with both banner size options
- Included ground stakes keep the display stationary in the breeze
- Lightweight and portable



Sunrise Lawn Sign

Item #	Description	1	2-5	6-11	12-24
263340	5'W x 4'H Single-Sided Kit	132.10	127.70	123.30	119.40
263341	5'W x 4'H Double-Sided Kit	207.60	201.00	194.30	188.10
263345	3'W x 5'H Single-Sided Kit	119.50	115.50	111.50	107.90
263346	3'W x 5'H Double-Sided Kit	182.40	176.50	170.60	165.10

Kit Includes: Hardware, Single- or Double-Sided Graphic and 2 Stakes USD MSRP (C)

Description	Product Size	Finished Graphic Size	Product Wt.	Media (Single / Double)
5'W x 4'H	59.5"W x 48"H x 1.625"D	View Online Template	2.3 lbs.	Super Poly Knit Fabric / Block-Out Polyester
3'W x 5'H	31.25"W x 56.625"H x 1.625"D	View Online Template	2.1 lbs.	Super Poly Knit Fabric / Block-Out Polyester

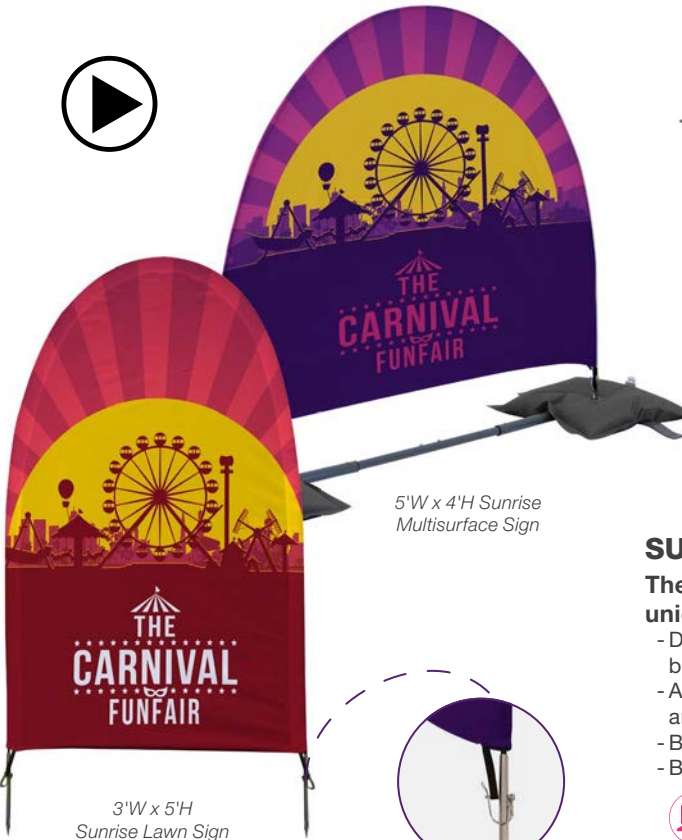

5'W x 4'H Sunrise Multisurface Sign

3'W x 5'H Sunrise Lawn Sign



Black tabs on bottom of banner attach to metal pin on ground stakes.



Double-sided banners feature a lightweight block-out polyester.



SUNRISE BOARDWALK STAND

- Converts Sunrise Lawn Sign into the Sunrise Multisurface Sign
- Stand can be adjusted to fit both sizes of the Sunrise Lawn Sign
- Includes two square water ballasts

Sunrise Boardwalk Stand

Item #	Description	Product Wt.	1	2-5	6-11	12-24
263351	Stand	11.7 lbs.	182.50	175.20	167.90	162.40

USD MSRP (C)

SUNRISE MULTISURFACE SIGN

The popular Sunrise Lawn Sign has been transformed to bring its unique shape to any event.

- Display on virtually any surface; kit includes stakes for soft surfaces and boardwalk stand with water ballasts for hard surfaces
- Artwork is dye sublimated on super poly knit fabric for single-sided banners and on block-out polyester for double-sided banners
- Boardwalk stand has an easy push-button assembly
- Banners have a 90-day warranty



Sunrise Multisurface Sign

Item #	Description	1	2-5	6-11	12-24
907070	5'W x 4'H Single-Sided Kit	314.75	303.00	291.25	281.75
907071	5'W x 4'H Double-Sided Kit	390.25	376.25	362.25	350.50
907072	3'W x 5'H Single-Sided Kit	302.00	290.75	279.25	270.25
907073	3'W x 5'H Double-Sided Kit	365.00	351.75	338.50	327.50

Kit Includes: Pole Hardware, Single- or Double-Sided Graphic, Boardwalk Base, 2 Stakes and 2 Square Water Ballasts USD MSRP (C)

Description	Product Size	Finished Graphic Size	Product Wt. (Single / Double)	Media (Single / Double)
5'W x 4'H	62.25"W x 48"H x 28.5"D	View Online Template	13.7 lbs. / 14 lbs.	Super Poly Knit Fabric / Block-Out Polyester
3'W x 5'H	40.125"W x 56.625"H x 28.5"D	View Online Template	13.5 lbs. / 13.8 lbs.	Super Poly Knit Fabric / Block-Out Polyester

HARDWARE-ONLY LEAD TIME: SHIPS SAME DAY WHEN ORDERED BEFORE 2 PM CENTRAL

Prices are subject to change; visit our website for the most current pricing.
Setup fee: \$20.00(G).

See pages 208-211 for additional information that may apply to your order.

AFTER FINAL PROOF APPROVAL
PRODUCTION LEAD TIME IS
4DAYS

Suggested Uses

Colleges
Trade Shows
City Centers
History Museums



WAYFINDING SIGN

Don't let your guests get lost! Provide direction with this rigid sign that can be attached to most signposts.

- Artwork is UV-printed on aluminum composite
- Available in a rectangular shape, or tipped with a pointed arrow
- Artwork is printed on both sides of the sign; different artwork can be used on each side
- Includes mounting bracket and two quick-release bands to hold the sign in place



Wayfinding Sign

Item #	Description	1	2-5	6-11	12-24
263580	Arrow Kit	109.00	105.20	101.40	98.10
263581	Rectangle Kit	89.00	85.80	82.55	79.90
Kit Includes: Mounting Hardware and Double-Sided Graphic		USD MSRP (C)			

Description	Product Size	Finished Graphic Size	Product Wt.	Media
Arrow	25.25"W x 6"H x 2.25"D	24"W x 6"H	1.2 lbs.	Aluminum Composite
Rectangle	25.25"W x 6"H x 2.25"D	24"W x 6"H	1.2 lbs.	Aluminum Composite



Display as either a rectangle or an arrow to point the way.



Easy installation with the included mounting bracket.

Suggested Uses

Restaurants
Business Complex
Vendor Shows
Sporting Events

PARKING PAL

This reflective sign has a narrow footprint and can be stacked for storage, making it perfect for event parking or public garages.

- Artwork is printed on reflective media
- Two single-sided decals make a double-sided display
- Durable plastic construction prevents rust and splinters
- Maintenance-free and weather-resistant
- NCHRP compliant
- Federal Highway Administration approved
- Decals used outdoors have a 90-day warranty; decals used indoors have a 1-year warranty

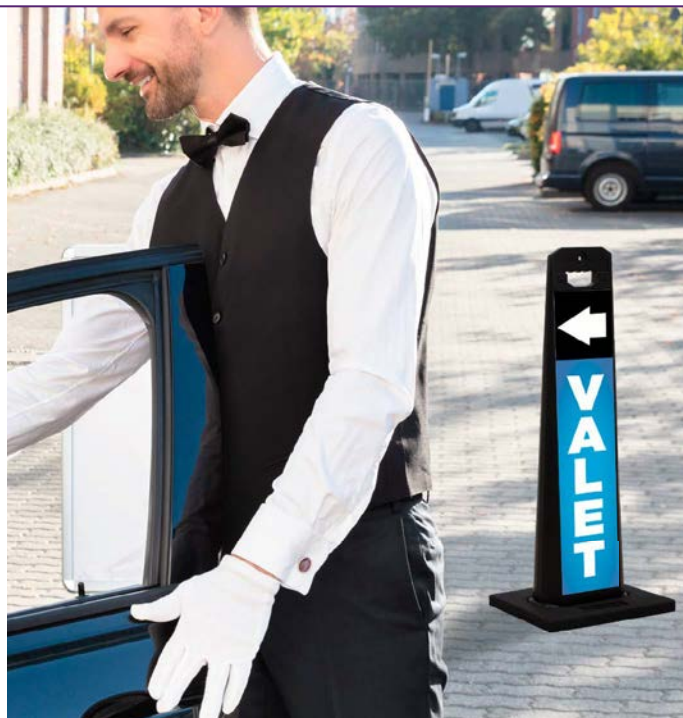

Parking Pal

Item #	Description	1	2-5	6-11	12-24
264260	Kit	163.60	157.80	152.00	147.10
Kit Includes: Hardware and 2 Installed Single-Sided Graphic Decals		USD MSRP (C)			

Product Size	Finished Graphic Size	Product Wt.	Media
17.625"W x 44.75"H x 14.5"D	8"W x 36"H	13 lbs.	Reflective Media



Removable rubber base for added stability.

Prices are subject to change; visit our website for the most current pricing.
Setup fee: \$20.00(G).
See pages 208-211 for additional information that may apply to your order.

AFTER FINAL PROOF APPROVAL
PRODUCTION LEAD TIME IS
3 DAYS

Suggested Uses

School Events
Vendor Shows
Boutiques
Sporting Events



Cube

Triangle

NEW
PRODUCT

Clear tabs attach to the corners of the display to hold the pieces together.

TOWER TRIO

This display features three stackable pieces that are easy to put together and look great in any space.

- Constructed of 4 mm corrugated plastic
- Stands more than 5' tall when assembled
- Triangle comes in nine individual pieces; includes 18 clear tabs for easy assembly
- Cube comes in 12 individual pieces; includes 24 clear tabs for easy assembly
- Corrugated plastic can be recycled after use

**Tower Trio**

Item #	Description	1	2-5	6-11	12-24
271180	Triangle Kit	190.30	184.30	176.90	174.20
271181	Cube Kit	253.75	245.75	236.00	232.25

Triangle Kit Includes: 9 Graphic Panels and 18 Clear Tabs
Cube Kit Includes: 12 Graphic Panels and 24 Clear Tabs

USD MSRP (C)

Description	Product Size	Finished Graphic Size	Product Wt.	Media
Triangle	24"W x 64.25"H x 24"D	23.75"W x 23.75"H	6 lbs.	4 mm Corrugated Plastic
Cube	33"W x 64.25"H x 33"D	23.75"W x 23.75"H	8 lbs.	4 mm Corrugated Plastic



AFTER FINAL PROOF APPROVAL
PRODUCTION LEAD TIME IS
2DAYS

Prices are subject to change; visit our website for the most current pricing.
Setup fee: \$20.00(G).

See pages 208-211 for additional information that may apply to your order.



SIGNAGE

WAYFINDING SIGN POST

This signpost is a true classic. Offer guidance with directional signage that can be attached to all four sides.

- Post is constructed of aluminum, with a steel base for stability
- Signage easily slides into slots in the post
- Artwork is UV-printed on aluminum composite
- Artwork is printed on both sides of the sign; different artwork can be used on each side
- Maximum of 16 signs can be attached to the post



Rectangle (Set of 4)

Arrow (Set of 8)

Wayfinding Sign Post

Item #	Description	1	2-5	6-11	12-24
263650	Rectangle Kit (Set of 4)	350.00	336.75	323.25	313.00
263651	Rectangle Kit (Set of 8)	420.00	404.50	389.00	376.75
263652	Arrow Kit (Set of 4)	380.00	365.75	351.50	340.25
263653	Arrow Kit (Set of 8)	480.00	462.75	445.50	431.25
Kit Includes: Hardware, 4 or 8 Double-Sided Graphics and Drawstring Pouch				USD MSRP (C)	

Description	Product Size	Finished Graphic Size	Product Wt. (Four / Eight)	Media
Rectangle	29.375" W x 87.375" H x 29.375" D	View Product Template	13.6 lbs. / 15.2 lbs.	Aluminum Composite
Arrow	29.375" W x 87.375" H x 29.375" D	View Product Template	13.6 lbs. / 15.2 lbs.	Aluminum Composite



Included hex wrenches are used to tighten pole, base and graphics.

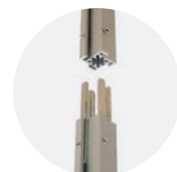

Slide poles together for assembly.

FLAT BASE SIGN DISPLAY

This sign display shows off your message with style.

- Contemporary look with rectangular tube frame and a sturdy base
- Hardware available in black or chrome
- Artwork is printed on 4 mm corrugated plastic
- Double-sided display



Flat Base Sign Display

Item #	Description	1	2-5	6-11	12-24
400055	Kit	197.60	191.70	183.80	177.80
Kit Include: Black or Chrome Hardware and Double-Sided Graphic				USD MSRP (C)	

Product Size	Finished Graphic Size	Product Wt.	Media
22.25" W x 59.75" H x 10" D	22" W x 28" H	13.5 lbs.	4 mm Corrugated Plastic



Prices are subject to change; visit our website for the most current pricing.
Setup fee: \$20.00(G).
See pages 208-211 for additional information that may apply to your order.

AFTER FINAL PROOF APPROVAL
PRODUCTION LEAD TIME IS
2 DAYS



Suggested Uses

- Retail Stores
- Libraries
- Hotels
- Banks



VALUE WALL-MOUNT SEG

This SEG display is ideal for long-term use in office or retail settings.

- Easily change out graphic to update messaging
- SEG provides a clean, frameless look
- Artwork is dye sublimated on recycled polyester knit
- 100% recycled media is made with REPREVE® fibers
- 1.25" frame depth
- Display can be hung vertically or horizontally
- Mounting hardware and assembly tools included



Value Wall-Mount SEG

Item #	Description	1	2-5	6-11	12-24
254920	11" x 17" Kit	79.00	76.00	72.00	68.00
254750	16" x 20" Kit	93.00	90.00	86.00	81.00
254923	22" x 28" Kit	110.00	105.00	101.00	95.00
254753	24" x 36" Kit	132.00	127.00	121.00	115.00
254756	30" x 40" Kit	164.00	157.00	151.00	143.00
254926	36" x 48" Kit	188.00	181.00	173.00	164.00
254759	30" x 60" Kit	214.00	205.00	197.00	187.00
254929	48" x 60" Kit	285.00	274.00	263.00	248.00

Kit Includes: Hardware and Graphic Panel

USD MSRP (C)

Description	Product Size	Finished Graphic Size	Product Wt.	Media
11" x 17"	11"W x 17"H x 1.25"D	View Online Template	2.2 lbs.	Recycled Polyester Knit
16" x 20"	16"W x 20"H x 1.25"D	View Online Template	2.5 lbs.	Recycled Polyester Knit
22" x 28"	22"W x 28"H x 1.25"D	View Online Template	3.2 lbs.	Recycled Polyester Knit
24" x 36"	24"W x 36"H x 1.25"D	View Online Template	3.5 lbs.	Recycled Polyester Knit
30" x 40"	29.875"W x 39.875"H x 1.25"D	View Online Template	4 lbs.	Recycled Polyester Knit
36" x 48"	36"W x 48"H x 1.25"D	View Online Template	4.8 lbs.	Recycled Polyester Knit
30" x 60"	30"W x 59.875"H x 1.25"D	View Online Template	5.25 lbs.	Recycled Polyester Knit
48" x 60"	48"W x 60"H x 1.25"D	View Online Template	6 lbs.	Recycled Polyester Knit



Pull tab lets you quickly remove SEG panel from the frame.



Included assembly tools let you easily install corner brackets.

AFTER FINAL PROOF APPROVAL
PRODUCTION LEAD TIME IS
4 DAYS

Prices are subject to change; visit our website for the most current pricing.

Setup fee: \$20.00(G).

See pages 208-211 for additional information that may apply to your order.

Suggested Uses

- Lobbies
- Schools
- Airports
- Restaurants



SIGNAGE

STANDARD WALL-MOUNT SEG GLO

Add a lasting glow to your space with this lit SEG display.

- Easily change out graphic to update messaging
- Backlit single-sided SEG provides a glow effect
- Artwork is dye sublimated on backlit woven polyester
- 2.5" frame depth
- Ladder lights mounted on a block-out back panel
- Tool-free assembly; mounting hardware included
- Display can be hung vertically or horizontally
- Plugs into any standard USA outlet
- Floor display option also available (see page 172)



Beveled edge allows for quick and easy SEG panel changes.

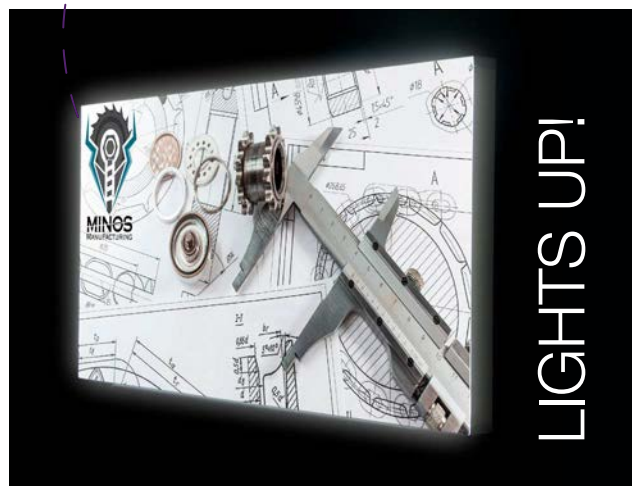

Standard Wall-Mount SEG Glo

Item #	Description	1	2-5	6-11	12-24
254932	11" x 17" Kit	145.00	139.00	134.00	126.00
254770	16" x 20" Kit	164.00	157.00	151.00	143.00
254935	22" x 28" Kit	205.00	197.00	188.00	179.00
254773	24" x 36" Kit	227.00	218.00	209.00	198.00
254776	30" x 40" Kit	283.00	271.00	260.00	246.00
254938	36" x 48" Kit	380.00	365.00	349.00	330.00
254779	30" x 60" Kit	441.00	423.00	406.00	383.00
254941	48" x 60" Kit	645.00	619.00	593.00	561.00

Kit Includes: Hardware, Back Panel with Ladder Lights and Graphic Panel USD MSRP (C)

Description	Product Size	Finished Graphic Size	Product Wt.	Media
11" x 17"	11"W x 17"H x 2.5"D	View Online Template	2.8 lbs.	Backlit Woven Polyester
16" x 20"	16"W x 20"H x 2.5"D	View Online Template	3.7 lbs.	Backlit Woven Polyester
22" x 28"	22"W x 28"H x 2.5"D	View Online Template	5.3 lbs.	Backlit Woven Polyester
24" x 36"	24"W x 36"H x 2.5"D	View Online Template	5.8 lbs.	Backlit Woven Polyester
30" x 40"	30"W x 40"H x 2.5"D	View Online Template	7 lbs.	Backlit Woven Polyester
36" x 48"	36"W x 48"H x 2.5"D	View Online Template	8 lbs.	Backlit Woven Polyester
30" x 60"	30"W x 60"H x 2.5"D	View Online Template	9.3 lbs.	Backlit Woven Polyester
48" x 60"	48"W x 60"H x 2.5"D	View Online Template	12.4 lbs.	Backlit Woven Polyester

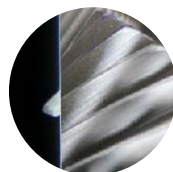

Pull tab lets you quickly remove SEG panel from the frame.



Ladder lights create a glow effect.

Prices are subject to change; visit our website for the most current pricing.

Setup fee: \$20.00(G).

See pages 208-211 for additional information that may apply to your order.

AFTER FINAL PROOF APPROVAL
PRODUCTION LEAD TIME IS
4 DAYS



NEW
PRODUCT

NEW
RECYCLED
POLYESTER
KNIT

36" x 36"

24" x 24"

36" x 18"



Easily clip
on chains
to install the
SEG display.



Pull tab lets you
quickly remove
SEG panel from
the frame.

AERIAL SEG

Put your brand where it can't be missed: overhead! This ceiling-mounted kit features beautifully vibrant graphics that hang from two chains to capture every eye in the room.

- Hangs from the ceiling with the included mounting kit, which features two 102" chains, two mounting brackets and a set of ceiling anchors
- SEG for easy graphic panel installation
- 2.375" frame depth
- Artwork is dye sublimated on recycled polyester knit
- 100% recycled media is made with REPVEVE® fibers
- Includes two graphic panels for a double-sided display



Aerial SEG

Item #	Description	1	2-5	6-11	12-24
263620	24"W x 24"H Kit	350.00	336.00	322.00	305.00
263629	36"W x 18"H Kit	375.00	360.00	345.00	326.00
263623	36"W x 36"H Kit	490.00	470.00	451.00	426.00
263626	48"W x 48"H Kit	625.00	600.00	575.00	544.00

Kit Includes: Hardware, 2 Graphic Panels, Hanging Hardware and Soft Carry Case USD MSRP (C)

Description	Product Size	Finished Graphic Size	Product Wt.	Media
	24"W x 24"H	24"W x 24.75"H x 2.375"D	4.4 lbs.	Recycled Polyester Knit
	36"W x 18"H	36"W x 18.75"H x 2.375"D	5 lbs.	Recycled Polyester Knit
	36"W x 36"H	36"W x 36.75"H x 2.375"D	5.8 lbs.	Recycled Polyester Knit
	48"W x 48"H	48"W x 48.75"H x 2.375"D	7.6 lbs.	Recycled Polyester Knit

AERIAL SEG GLO

This light-up display is a marketing powerhouse that hangs from the ceiling. Elevate your message overhead and emphasize it with a pleasant glow.

- Hangs from the ceiling with the included mounting kit, which features two 102" chains, two mounting brackets and a set of ceiling anchors
- SEG for easy graphic panel installation
- 2.375" frame depth
- Artwork is dye sublimated on backlit woven polyester
- Includes two graphic panels for a double-sided display
- Plugs into any standard USA outlet
- A power button on the frame allows the sign to be turned on and off with a touch of your finger
- Power cord comes out of the top of the display to prevent tangles



Aerial SEG Glo

Item #	Description	1	2-5	6-11	12-24
263600	24"W x 24"H Kit	625.00	600.00	575.00	544.00
263609	36"W x 18"H Kit	695.00	668.00	639.00	605.00
263603	36"W x 36"H Kit	775.00	744.00	713.00	674.00
263606	48"W x 48"H Kit	940.00	902.00	865.00	818.00

Kit Includes: Hardware, 2 Graphic Panels, Hanging Hardware and Soft Carry Case USD MSRP (C)

Description	Product Size	Finished Graphic Size	Product Wt.	Media
	24"W x 24"H	24"W x 24.75"H x 2.375"D	5 lbs.	Backlit Woven Polyester
	36"W x 18"H	36"W x 18.75"H x 2.375"D	6 lbs.	Backlit Woven Polyester
	36"W x 36"H	36"W x 36.75"H x 2.375"D	7.6 lbs.	Backlit Woven Polyester
	48"W x 48"H	48"W x 48.75"H x 2.375"D	10.2 lbs.	Backlit Woven Polyester



NEW
PRODUCT

NEW
BACKLIT
MEDIA



Button on the
side of the
frame lets you
turn on and off
the LED lights.



Built-in LED
lights create
a glow effect.

AFTER FINAL PROOF APPROVAL
PRODUCTION LEAD TIME IS
4 DAYS

Prices are subject to change; visit our website for the most current pricing.
Setup fee: \$20.00(G).

See pages 208-211 for additional information that may apply to your order.

CRYSTAL EDGE DISPLAY

The glow of this illuminated sign will draw every eye in the room.

- Optical acrylic frame
- LED power lasts more than 50,000 hours
- Artwork is printed on Titan™ backlit film
- Can be displayed horizontally or vertically; hanging hardware included
- Plugs into any standard USA outlet
- UL listed



Crystal Edge Display

Item #	Description	1	2-5	6-11	12-24
325050	14" x 20" Kit	314.75	305.25	292.75	283.25
325052	25" x 31" Kit	472.00	457.75	439.00	424.75
Kit Includes: Frame, Backlit Graphic, AC Adapter and Mounting Hardware				USD MSRP (C)	

Description	Product Size	Finished Graphic Size	Product Wt.	Media
14" x 20"	19.75"W x 13.75"H x 1.25"D	16"W x 10"H	5 lbs.	Titan™ Backlit Film
25" x 31"	30.75"W x 24.75"H x 1.75"D	27"W x 21"H	13.7 lbs.	Titan™ Backlit Film



SIGNAGE



Loosen bolts when you need to swap out posters.

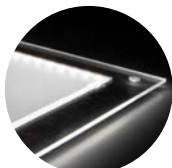

Powerful LED lights along the inside edges of the frame diffuse the light evenly for a gentle glow.

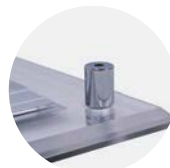

Standoffs create space between wall and display to emphasize illumination.

Suggested Uses

- Restaurants
- Bars
- Wedding Expos
- Liquor Stores

LED LIGHT BOX

LED light boxes offer a brighter and more energy-efficient alternative to traditional light box designs.

- Lightweight aluminum frame can be hung vertically or horizontally; hanging hardware included
- LED power lasts more than 50,000 hours
- Artwork is printed on Titan™ backlit film
- Plugs into any standard USA outlet
- UL listed



LED Light Box

Item #	Description	1	2-5	6-11	12-24
325031	23.5" x 17.5" Kit	384.00	372.50	357.00	345.50
325032	27.5" x 21.5" Kit	522.50	507.00	486.00	470.50
325033	35.5" x 23.5" Kit	742.50	720.00	690.50	668.50
Kit Includes: Frame, Backlit Graphic, AC Adapter and Mounting Hardware				USD MSRP (C)	

Description	Product Size	Finished Graphic Size	Product Wt.	Media
23.5" x 17.5"	25.6"W x 19.6"H x 0.875"D	23.5"W x 17.5"H	8.5 lbs.	Titan™ Backlit Film
27.5" x 21.5"	29.6"W x 23.6"H x 0.875"D	27.5"W x 21.5"H	10.5 lbs.	Titan™ Backlit Film
35.5" x 23.5"	37.6"W x 25.6"H x 0.875"D	35.5"W x 23.5"H	14 lbs.	Titan™ Backlit Film



Edges flip open so swapping out posters is easy.



Powerful LED lights along the inside of the frame create a soothing glow.

Prices are subject to change; visit our website for the most current pricing.

Setup fee: \$20.00(G).

See pages 208-211 for additional information that may apply to your order.

AFTER FINAL PROOF APPROVAL
PRODUCTION LEAD TIME IS
2DAYS



23"W x 18"H Luxe Glo Edge

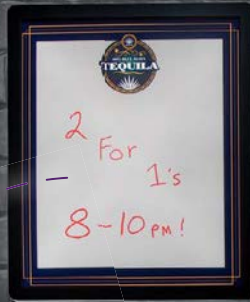

23"W Round Luxe Glo Sign

15"W x 18"H
Luxe Glo Message Board23"W x 18"H
Rectangle Luxe Glo Sign

LIGHTS UP!



Red fluorescent marker is included with Luxe Glo Message Board.

LUXE GLO SIGN DISPLAYS

Light up your brand with these LED displays that will last for years.

- Luxe Glo Sign is available in round and rectangular shapes
- Artwork is vibrantly printed on white polycarbonate
- Luxe Glo Message Board artwork spans the entire sign; red fluorescent marker included
- UL listed
- Plugs into any standard USA outlet
- Not eligible for Rush Service



Luxe Glo Sign

Item #	Description	Product Wt.	1	2-5	6-11	12-24
271150	15" Round	3 lbs.	346.00	332.25	318.25	308.00
271151	23" Round	6.6 lbs.	472.00	453.00	434.25	420.00
271152	18"W x 15"H Rectangle	3 lbs.	377.50	362.50	347.25	336.00
271153	23"W x 18"H Rectangle	6.4 lbs.	472.00	453.00	434.25	420.00

USD MSRP (C)

Luxe Glo Edge

Item #	Description	Product Wt.	1	2-5	6-11	12-24
271160	18"W x 15"H	4.6 lbs.	377.50	362.50	347.25	336.00
271161	23"W x 18"H	6.6 lbs.	472.00	453.00	434.25	420.00

USD MSRP (C)

Luxe Glo Message Board

Item #	Description	Product Wt.	1	2-5	6-11	12-24
271170	15"W x 18"H Kit	3.2 lbs.	377.50	362.50	347.25	336.00
271171	18"W x 23"H Kit	6.4 lbs.	472.00	453.00	434.25	420.00

Kit Includes: Imprinted Sign and Red Fluorescent Marker

USD MSRP (C)



Hanging and wall-mounting hardware included.



AFTER FINAL PROOF APPROVAL
PRODUCTION LEAD TIME IS
7 DAYS

Prices are subject to change; visit our website for the most current pricing.

Setup fee: \$20.00(G).

See pages 208-211 for additional information that may apply to your order.

Suggested Uses

Retail Stores
Schools
Car Dealerships
Offices

OPAQUE WINDOW CLING

Dress up your window with these convenient, reusable, opaque clings.

- Durable and long-lasting
- Clings to window without adhesive; leaves no residue
- Artwork is printed on the non-cling side of the material
- Single-sided; backside will show white
- Removable and reusable
- Indoor or outdoor use
- Clean with standard window cleaner
- Water resistant; fade resistant up to 6-months



Opaque Window Cling

Item #	Description	Product Wt.	1	2-5	6-11	12-24
325240	8" x 8"	0.02 lb.	17.60	17.07	16.54	16.02
325241	12" x 12"	0.04 lb.	20.15	19.55	18.94	18.34
325242	12" x 18"	0.06 lb.	25.15	24.40	23.64	22.89
325243	18" x 24"	0.11 lb.	32.70	31.72	30.74	29.76
325244	20" x 30"	0.16 lb.	35.25	34.19	33.14	32.08
325245	24" x 24"	0.15 lb.	40.25	39.04	37.84	36.63
325246	24" x 36"	0.23 lb.	45.30	43.94	42.58	41.22
325247	36" x 48"	0.45 lb.	60.45	58.65	56.80	55.00

USD MSRP (C)



SIGNAGE



Artwork is printed on the non-cling side of the material; cling is adhered to outside of window.



Vibrant colors pop on white opaque window film.

MAGNET PROMO SIGN

Magnetize your business on the go or in the office with these flexible, magnetic signs.

- Adhere to indoor and outdoor magnetic surfaces
- Flexible single-sided magnet lays flat for a clean look
- Smooth white basecoat makes colors pop
- Custom sizes available (call for quote; restrictions may apply)
- Magnet signs have a 90-day warranty



Magnet Promo Sign

Item #	Description	Product Wt.	1	2-5	6-11	12-24
264340	12" x 12"	0.4 lb.	18.88	18.31	17.75	17.18
264341	12" x 18"	0.6 lb.	22.67	21.99	21.31	20.63
264342	12" x 24"	0.8 lb.	25.17	24.41	23.66	22.90
264343	18" x 18"	1 lb.	28.96	28.09	27.22	26.35
264344	18" x 24"	1.2 lbs.	31.46	30.52	29.57	28.63
264345	24" x 24"	1.6 lbs.	35.26	34.20	33.14	32.09

USD MSRP (C)



Black magnet with smooth white basecoat on print side.

Prices are subject to change; visit our website for the most current pricing.
Setup fee: \$20.00(G).
See pages 208-211 for additional information that may apply to your order.

WINDOW CLING | MAGNET
AFTER FINAL PROOF APPROVAL
PRODUCTION LEAD TIME IS
2 & 3 DAYS

INDOOR SURFACE GRIP

This temporary floor or wall decal works on a variety of surface types, even carpet.

- Textured matte vinyl with fabric backing and solvent acrylic adhesive
- Rounded corners for a finished look
- Easy to apply and remove
- Different artwork can be applied to each footprint/circle
- One-year warranty when used on walls; 30-day warranty when used on floors
- Certified slip resistant (UL410)
- Custom sizes and shapes available (call for quote; restrictions may apply)



Indoor Surface Grip

Item #	Description	Product Wt.	1	2-5	6-11	12-24
259060	2' x 4'	0.6 lb.	81.95	79.50	77.05	74.55
259065	3' x 5'	1.2 lbs.	162.30	157.40	152.60	147.70
259066	3' x 8'	2 lbs.	242.90	235.60	228.30	221.00
259061	4' x 4'	1.2 lbs.	164.80	159.90	154.90	150.00
259067	4' x 6'	1.4 lbs.	221.50	214.90	208.20	201.60
259062	4' x 8'	2.4 lbs.	321.00	311.25	301.75	292.00
259069	12" Circle (Set of 3)	0.05 lb.	50.35	48.85	47.35	45.80
259089	12" Circle (Set of 6)	0.1 lb.	97.65	94.70	91.80	88.85
259068	18" Circle (Set of 6)	0.2 lb.	124.60	120.90	117.10	113.40
259063	42" Circle	0.6 lb.	164.80	159.90	154.90	150.00
259064	72" x 42" Arrow	0.8 lb.	390.25	378.50	366.75	355.25
259088	Footprints (Set of 10)	0.2 lb.	43.80	42.49	41.17	39.86

USD MSRP (C)



4' x 8'



42" Circle



Footprints (available in Surface Grip only)



Arrow



12" Circle (Set of 6)

OUTDOOR SURFACE TAC

Designed for walkable and drivable surfaces, Surface Tac is perfect for outdoor use.

- Artwork is printed on durable, no-tear and scratch-resistant high-tack surface film
- Rounded corners for a finished look
- Certified slip resistant (ASTM D-2047)
- Different artwork can be applied to each circle
- Custom sizes and shapes available (call for quote; restrictions may apply)



Outdoor Surface Tac

Item #	Description	Product Wt.	1	2-5	6-11	12-24
259092	12" Circle (Set of 3)	0.4 lb.	81.80	79.35	76.90	74.45
259093	12" Circle (Set of 6)	0.8 lb.	158.50	153.70	149.00	144.20
259094	18" Circle (Set of 6)	1 lb.	289.25	280.50	272.00	263.25
259074	72" x 42" Arrow	1.2 lbs.	402.75	390.75	378.50	366.50

USD MSRP (C)



AFTER FINAL PROOF APPROVAL
PRODUCTION LEAD TIME IS
3DAYS

Prices are subject to change; visit our website for the most current pricing.
Setup fee: \$20.00(G).
See pages 208-211 for additional information that may apply to your order.

STORM MAT

This water-absorbent mat makes a great first impression when placed in entryways.

- Absorbs up to 1.5 gallons of liquid per square yard
- Easy to clean using a vacuum, steam cleaner or hose
- UV-resistant and treated with Stainstopper™
- Mat sizes are not exact; allow 3-5% size variance
- Art restrictions may apply, see page 209
- Not eligible for Rush Service



Storm Mat

Item #	Description	Product Wt.	1	2-5	6-10	11-25
259030	2' x 3'	4 lbs.	402.50	330.00	285.75	273.75
259031	3' x 5'	10 lbs.	458.25	375.75	325.25	311.50
259032	4' x 6'	14 lbs.	581.00	476.50	412.50	395.00

USD MSRP (C)

Light colors show dirt easily and are not recommended for background colors. Item has limited number of available colors (56). We cannot guarantee color matching. Test strip/match print/test grid not available.

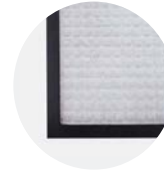

Constructed of 65 mil nitrile rubber with needle-punched polyester carpet.

FLOOR HUGGER MAT

Put quality designs right at your feet. The Floor Hugger mat features a nylon yarn surface with black rubber borders and backing.

- Treated with Stainstopper™ and static dissipative
- Will not crack or curl
- Produced with polyester PET yarn consisting of 100% post-consumer recycled content
- Mat sizes are not exact; allow 3-5% size variance
- Art restrictions may apply, see page 209
- Not eligible for Rush Service



Floor Hugger Mat

Item #	Description	Product Wt.	1	2-5	6-10	11-25
259000	3' x 5'	8 lbs.	342.50	280.75	243.25	233.00
259001	3' x 10'	16 lbs.	562.50	461.50	399.50	382.50
259002	4' x 6'	12 lbs.	437.75	359.00	310.75	297.75

USD MSRP (C)

Light colors show dirt easily and are not recommended for background colors. Item has limited number of available colors (150). We cannot guarantee color matching. Test strip/match print/test grid not available.

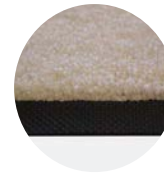

Mat features chemical-resistant plush carpet.

FLOOR DECOR

High-quality, foam-backed flooring is extremely durable, and it's perfect for grabbing attention in lobbies or at events.

- Artwork is printed on one side of the Floor Decor
- Lays flat for a clean, smooth look
- Wipes clean with a damp cloth
- Custom sizes and shapes available (call for quote; restrictions may apply)
- Best for indoor use
- 10' x 10' and 9' round Floor Decor must ship by truck



Floor Decor

Item #	Description	Product Wt.	1	2-5	6-11	12-24
259058	3' x 3'	1.6 lbs.	273.00	264.75	256.50	248.50
259059	3' Round	1.2 lbs.	273.00	264.75	256.50	248.50
259050	8' x 8'	14 lbs.	1095.00	1062.00	1029.00	996.00
259051	8' x 10'	17 lbs.	1095.00	1062.00	1029.00	996.00
259053	9' Round	14 lbs.	1303.00	1264.00	1225.00	1186.00
259052	10' x 10'	22 lbs.	1303.00	1264.00	1225.00	1186.00

USD MSRP (C)

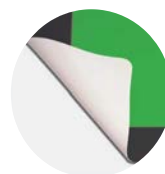

Finished with rounded corners.



2.4 mm PVC-coated fabric is backed with PVC foam.

Prices are subject to change; visit our website for the most current pricing.
Setup fee: \$20.00(G).
See pages 208-211 for additional information that may apply to your order.

STORM / HUGGER DECOR
AFTER FINAL PROOF APPROVAL
PRODUCTION LEAD TIME IS
7 OF 3 DAYS

DECOR

When choosing decor

have you considered...

- **LOCATION** - Where will these products be used?
- **FLEXIBILITY** - Will you be changing out your look and message frequently?
- **SIZE** - How large is your display space?
- **FABRIC/MEDIA** - What type of material are you looking for?



Suggested Uses

Home Gardens
Conservatories
Cemeteries
City Parks



DECOR

GARDEN FLAG

Spruce up your landscape with these Garden Flags.

- Artwork is printed on 200 denier nylon
- Single- and double-sided options available
- Single-sided flags show artwork on one side with the reverse image visible through the back
- Double-sided flags feature two layers sewn together with a block-out liner in between
- Flags used outdoors have a 90-day warranty; flags used indoors have a 1-year warranty



Garden Flag

Item #	Description	Product Wt.	1	2-5	6-11	12-24
304630	12" x 18" Single-Sided Kit	1.25 lbs.	66.70	53.35	50.05	43.35
304631	12" x 18" Double-Sided Kit	1.5 lbs.	112.00	89.60	84.00	72.80
304635	30" x 48" Single-Sided Kit	5.5 lbs.	173.70	139.00	130.30	112.90
304636	30" x 48" Double-Sided Kit	6 lbs.	274.25	219.50	205.75	178.25

Kit Includes: Hardware and Graphic
USD MSRP (C)



Included hardware is simple to set up.

Suggested Uses

Model Homes
Offices
Schools
Clinics



DOOR WRAP

Decorate your home or office doors using this attractive fabric wrap.

- Artwork is dye sublimated on two-way stretch fabric
- No adhesive tape needed
- Fits standard doors 80" tall
- Double-sided graphic cover is viewable from both the front and back of the door
- Different artwork can be used on each side
- Custom sizes available (call for quote; restrictions may apply)
- Wraps used outdoors have a 90-day warranty; wraps used indoors have a 1-year warranty



Door Wrap

Item #	Description	Product Wt.	1	2-5	6-11	12-24
263164	24"W	1.25 lbs.	162.30	157.40	152.60	147.70
263165	31"W	1.5 lbs.	187.50	181.90	176.30	170.60

USD MSRP (C)



Wraps around both sides of the door.



Easy setup: Simply slide the wrap over a door.

Prices are subject to change; visit our website for the most current pricing.
Setup fee: \$20.00(G).
See pages 208-211 for additional information that may apply to your order.

AFTER FINAL PROOF APPROVAL
PRODUCTION LEAD TIME IS
4 DAYS



BLANKETS

Add extra coziness to any room with these snuggly soft blankets.

- Artwork is dye sublimated on soft fleece fabric
- Single-sided
- Velveteen and Fleece unprinted side is white
- Sherpa unprinted side is ivory
- Machine wash on cold gentle cycle and tumble dry, no heat
- Available in three sizes



Sherpa, Velveteen and Fleece feature different fabric textures.



Sherpa blanket is finished with a whipstitched edge.

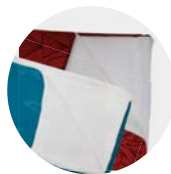

Velveteen and Fleece blankets are finished with a hemmed edge.

Velveteen Blanket

Item #	Description	Product Wt.	1	2-5	6-11	12-24
281113	30" x 40"	0.5 lb.	37.75	36.62	35.11	33.98
281114	50" x 60"	1.3 lbs.	56.60	54.90	53.20	51.50
281115	60" x 80"	2.1 lbs.	75.50	73.25	70.95	68.70

USD MSRP (C)

Fleece Blanket

Item #	Description	Product Wt.	1	2-5	6-11	12-24
281116	30" x 40"	0.5 lb.	31.45	30.51	29.56	28.62
281117	50" x 60"	1.3 lbs.	50.35	48.85	47.35	45.80
281118	60" x 80"	2.1 lbs.	69.20	67.10	65.05	62.95

USD MSRP (C)

Sherpa Blanket

Item #	Description	Product Wt.	1	2-5	6-11	12-24
281110	30" x 40"	0.8 lb.	44.04	42.72	40.96	39.64
281111	50" x 60"	2 lbs.	62.95	61.05	58.55	56.65
281112	60" x 80"	3.2 lbs.	81.80	79.35	76.05	73.60

USD MSRP (C)



INDOOR PILLOWS

Instantly revitalize and add comfort to any space with these custom pillows.

- Artwork printed on durable textured polyester fabric
- Available in four sizes
- Single- and double-sided options available
- Poly-fil pillow insert
- Zipper closure
- Pillow cover is machine-washable; wash on cold gentle cycle and tumble dry, no heat



Textured fabric gives style and depth to the pillow cover.



The reverse side of single-sided pillows is white.

Indoor Pillows

Item #	Description	Product Wt.	1	2-5	6-11	12-24
281200	16" x 16" Single-Sided Kit	1.2 lbs.	44.04	42.72	41.40	40.08
281201	16" x 16" Double-Sided Kit	1.2 lbs.	50.35	48.85	47.35	45.80
281202	18" x 18" Single-Sided Kit	1.4 lbs.	50.35	48.85	47.35	45.80
281203	18" x 18" Double-Sided Kit	1.4 lbs.	56.60	54.90	53.20	51.50
281204	14" x 20" Single-Sided Kit	1.3 lbs.	50.35	48.85	47.35	45.80
281205	14" x 20" Double-Sided Kit	1.3 lbs.	56.60	54.90	53.20	51.50
281206	20" x 20" Single-Sided Kit	1.6 lbs.	62.95	61.05	59.15	57.30
281207	20" x 20" Double-Sided Kit	1.6 lbs.	69.20	67.10	65.05	62.95

Kit Includes: Pillow Graphic Cover and Installed Poly-Fil Insert

USD MSRP (C)

BLANKETS | PILLOWS
AFTER FINAL PROOF APPROVAL
PRODUCTION LEAD TIME IS
3 OF 2 DAYS

Prices are subject to change; visit our website for the most current pricing.
Setup fee: \$20.00(G).

See pages 208-211 for additional information that may apply to your order.

Suggested Uses

Food Courts
Lobbies
Vacation Rentals
Showrooms

ALUMINUM PRINTS

Make your art shine with a sleek and modern aluminum print.

- Perfect for use as plaques, signage, or home decor
- Scratch-resistant for long-term use
- A white base coat makes colors pop
- Available with installed shadow mount or as print only
- Print is single-sided
- No assembly required



Aluminum Prints

Item #	Description	Product Wt.	1	2-5	6-11	12-24
264220	5" x 7"	0.2 lb.	18.88	18.31	17.75	17.18
264200	8" x 8"	0.2 lb.	21.37	20.73	20.09	19.45
264202	8" x 10"	0.25 lb.	25.16	24.41	23.65	22.90
264222	8" x 24"	0.6 lb.	57.85	56.10	54.40	52.65
264224	10" x 20"	0.75 lb.	38.38	37.23	36.08	34.93
264206	11" x 14"	0.45 lb.	52.85	51.25	49.70	48.10
264204	12" x 12"	0.4 lb.	36.50	35.41	34.31	33.22
264208	12" x 18"	0.6 lb.	61.65	59.80	57.95	56.10
264226	15" x 30"	1.6 lbs.	125.90	122.10	118.30	114.60
264210	16" x 16"	0.7 lb.	51.60	50.05	48.50	46.95
264212	16" x 20"	0.8 lb.	81.80	79.35	76.90	74.45
264214	20" x 24"	1.2 lbs.	118.40	114.80	111.30	107.70
264216	20" x 30"	1.8 lbs.	151.00	146.50	141.90	137.40
264228	24" x 24"	1.7 lbs.	163.60	158.70	153.80	148.90
264218	24" x 36"	2.6 lbs.	264.25	256.25	248.50	240.50

USD MSRP (C)

Aluminum Prints with Shadow Mount

Item #	Description	Product Wt.	1	2-5	6-11	12-24
264221	5" x 7"	0.4 lb.	25.17	24.41	23.66	22.90
264201	8" x 8"	0.4 lb.	27.66	26.83	26.00	25.17
264203	8" x 10"	0.5 lb.	31.46	30.52	29.57	28.63
264223	8" x 24"	0.8 lb.	64.20	62.25	60.35	58.40
264225	10" x 20"	0.95 lb.	44.67	43.33	41.99	40.65
264207	11" x 14"	0.65 lb.	59.10	57.35	55.55	53.80
264205	12" x 12"	0.6 lb.	42.80	41.52	40.23	38.95
264209	12" x 18"	0.8 lb.	71.10	68.95	66.85	64.70
264227	15" x 30"	3 lbs.	135.30	131.20	127.20	123.10
264211	16" x 16"	0.9 lb.	61.05	59.20	57.40	55.55
264213	16" x 20"	2.2 lbs.	91.25	88.50	85.80	83.05
264215	20" x 24"	2.6 lbs.	127.70	123.90	120.00	116.20
264217	20" x 30"	3.2 lbs.	160.50	155.70	150.90	146.10
264229	24" x 24"	3.1 lbs.	173.10	167.90	162.70	157.50
264219	24" x 36"	4 lbs.	274.25	266.00	257.75	249.50

USD MSRP (C)



DECOR



Hidden shadow mount hardware lets you hang your art on the wall like a picture frame.

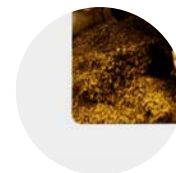

Finished with rounded corners.



These stands feature a satin finish and turn your print into a freestanding display.



16" x 16" print with 12" stand

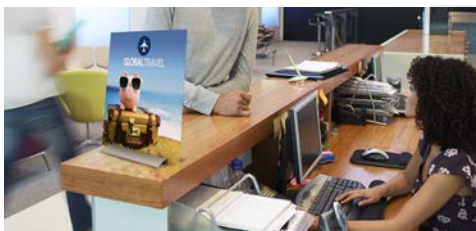

Add-On

Aluminum Print Stand

Item #	Description	Product Wt.	1	2-5	6-11	12-24
264092	8" Stand	0.2 lb.	15.76	15.13	14.50	14.03
264093	12" Stand	0.4 lb.	22.67	21.76	20.86	20.18

8" Stand holds up to a 12" x 12" print.
12" Stand holds up to a 16" x 16" print.

USD MSRP (C)

HARDWARE-ONLY LEAD TIME: SHIPS SAME DAY WHEN ORDERED BEFORE 2 PM CENTRAL

Prices are subject to change; visit our website for the most current pricing.
Setup fee: \$20.00(G).
See pages 208-211 for additional information that may apply to your order.

AFTER FINAL PROOF APPROVAL
PRODUCTION LEAD TIME IS
2 DAYS



ACRYLIC PRINTS

Create eye-catching decor with modern acrylic prints that offer sharp image detail and radiant colors.

- High-quality print on 0.118" acrylic
- Polished edge brings vibrancy and depth to the print
- Hang your art on the wall easily with attached shadow mount hardware
- Print is single-sided
- No assembly required



Acrylic Prints

Item #	Description	Product Wt.	1	2-5	6-11	12-24
264460	5" x 7"	0.44 lb.	27.66	26.83	26.55	26.28
264461	8" x 10"	0.76 lb.	35.26	34.20	33.85	33.50
264462	11" x 14"	1.27 lbs.	56.65	54.95	54.40	53.80
264463	12" x 12"	1.2 lbs.	60.40	58.60	58.00	57.40
264464	16" x 16"	3.18 lbs.	94.40	91.55	90.60	89.70
264465	16" x 20"	3.62 lbs.	100.70	97.70	96.70	95.70
264466	20" x 30"	5.57 lbs.	138.40	134.20	132.90	131.50
264467	24" x 36"	7.4 lbs.	188.80	183.10	181.20	179.40

USD MSRP (C)



Hidden shadow mount hardware lets you hang your art on the wall like a picture frame.

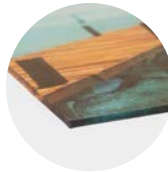

Acrylic prints provide additional depth to images.



Mix and match prints and sizes to create a focal wall.



LUX PRINTS

Personalize your home or office with this elegantly framed fabric print.

- SEG for easy graphic installation
- Easily change out print without replacing entire product
- Artwork is dye sublimated on recycled polyester knit
- 100% recycled media is made with REPREVE® fibers
- Minimal black metal frame gives print a sleek finish
- Frame allows for print to be displayed vertically or horizontally



Lux Prints

Item #	Description	Product Wt.	1	2-5	6-11	12-24
281300	8" x 10"	0.7 lb.	69.20	67.15	66.45	65.75
281301	12" x 12"	1 lb.	81.80	79.35	78.55	77.75
281302	16" x 16"	1.3 lbs.	94.40	91.55	90.65	89.65
281303	16" x 20"	1.6 lbs.	106.90	103.70	102.70	101.60

Kit Includes: Hardware and Installed Graphic USD MSRP (C)



Easy to hang hardware lets you place your art on the wall like a picture frame.



With a quick press of your thumb, the fabric's gasket edges are pushed into narrow channels built into the frame.

ACRYLIC | LUX
AFTER FINAL PROOF APPROVAL
PRODUCTION LEAD TIME IS
2 OF 3 DAYS

Prices are subject to change; visit our website for the most current pricing.
Setup fee: \$20.00(G).
See pages 208-211 for additional information that may apply to your order.

Suggested Uses

Malls
Game Rooms
Convention Centers
Restaurants

GALLERY PRINTS

Turn your favorite photos and memories into beautiful decoration pieces with our hanging Gallery Prints.

- Print is gallery-wrapped around frame to maximize graphic space
- Prints come with a finished back; hanging hardware is included
- Full image wraps around the sides of the canvas frame
- Prints can be displayed vertically or horizontally
- Artwork is printed with UV-protected ink on durable canvas fabric
- Wood frames are sourced from sustainable Appalachian hardwood lumber



Gallery Prints

Item #	Description	1	2-5	6-11	12-24
325400	8" x 10"	75.50	73.25	70.20	67.95
325401	11" x 14"	88.10	85.45	81.95	79.30
325402	12" x 12"	94.40	91.55	87.80	84.95
325403	16" x 20"	113.30	109.90	105.40	102.00

USD MSRP (C)

Description	Product Size	Finished Graphic Size	Product Wt.	Media
8" x 10"	8.25"W x 10.125"H x 1.625"D	8" x 10"	1 lb.	Canvas Fabric
11" x 14"	11.25"W x 14.125"H x 1.625"D	11" x 14"	1.5 lbs.	Canvas Fabric
12" x 12"	2.125"W x 12.125"H x 1.625"D	12" x 12"	1.5 lbs.	Canvas Fabric
16" x 20"	16.125"W x 20.25"H x 1.625"D	16" x 20"	2.4 lbs.	Canvas Fabric

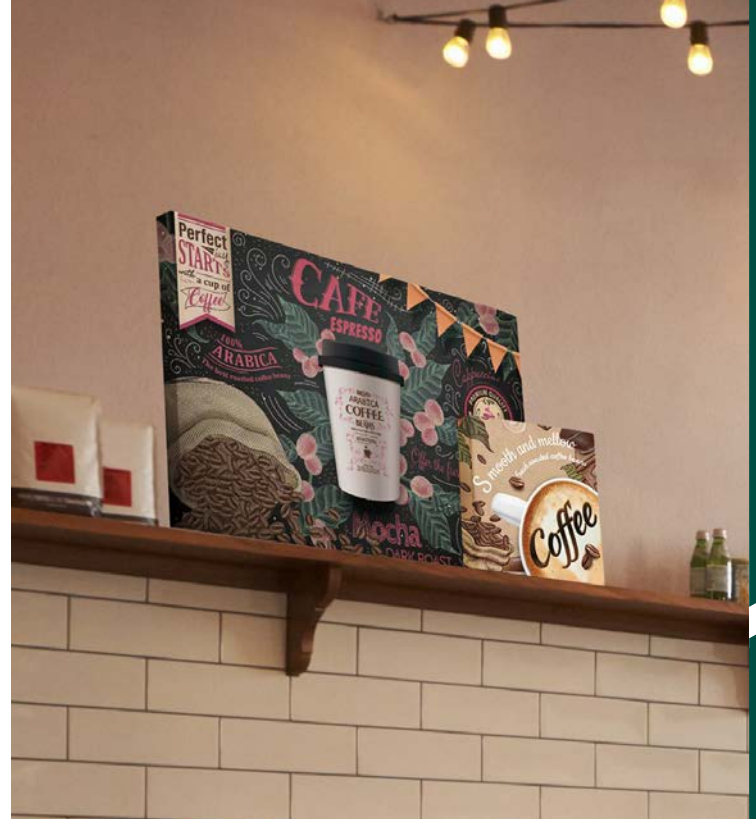

Gallery Print extends almost 2" from the wall.

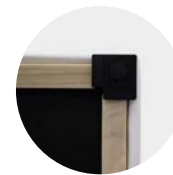

Black corner caps are non-marking bumpers to protect your walls.

FLOATING GALLERY PRINTS

Enhance your photos and artwork with a modern black frame.

- Gallery-wrapped prints are enclosed in a chic black frame to complete the modern look
- Prints come with a finished back; hanging hardware is included
- Prints can be displayed vertically or horizontally
- Artwork is printed with UV-protected ink on durable canvas fabric
- Wood frames are sourced from sustainable Appalachian hardwood lumber



Floating Gallery Prints

Item #	Description	1	2-5	6-11	12-24
325410	8" x 10"	125.80	122.00	117.00	113.20
325411	11" x 14"	144.80	140.50	134.70	130.30
325412	12" x 12"	163.60	158.70	152.10	147.20
325413	16" x 20"	201.40	195.40	187.30	181.30

USD MSRP (C)

Description	Product Size	Finished Graphic Size	Product Wt.	Media
8" x 10"	10.125"W x 12.125"H x 2"D	8" x 10"	2.2lbs.	Canvas Fabric
11" x 14"	13"W x 16"H x 2"D	11" x 14"	3 lbs.	Canvas Fabric
12" x 12"	14"W x 14"H x 2"D	12" x 12"	3 lbs.	Canvas Fabric
16" x 20"	18.125"W x 22.25"H x 2"D	16" x 20"	4.8 lbs.	Canvas Fabric



Elegant black frame gives the Floating Gallery Print a finished look.

Prices are subject to change; visit our website for the most current pricing.
Setup fee: \$20.00(G).
See pages 208-211 for additional information that may apply to your order.

AFTER FINAL PROOF APPROVAL
PRODUCTION LEAD TIME IS
3 DAYS



WOOD PRINTS

Add the rustic look of wood to a wall with this beautiful print option.

- Signs are available slatted for a rustic appearance or unslatted for a smooth look
- Features an exposed wood edge
- Available in four sizes
- MDF features a white coating to make your artwork pop
- Includes hanging hardware (assembly required)



Wood Prints

Item #	Description	Product Wt.	1	2-5	6-11	12-24
325481	8" x 12"	1 lb.	20.00	19.40	19.20	19.00
325482	11" x 17"	2 lbs.	34.00	32.98	32.64	32.30
325478	12" x 12"	1.6 lbs.	25.00	24.25	24.00	23.75
325480	12" Round	1.6 lbs.	25.00	24.25	24.00	23.75
325484	8" x 12" Slatted	1 lb.	20.00	19.40	19.20	19.00
325485	11" x 17" Slatted	2 lbs.	34.00	32.98	32.64	32.30
325479	12" x 12" Slatted	1.6 lbs.	25.00	24.25	24.00	23.75
325483	12" Round Slatted	1.6 lbs.	25.00	24.25	24.00	23.75

USD MSRP (C)



Hanging hardware is included but must be assembled.



Slats are spaced 1/16" apart.



TAPESTRIES

Accent your space with your own artistic touch.

- Artwork is dye sublimated on lightweight polyester fabric
- Crisp, laser-cut edges for a clean look
- Single-sided
- Available in three sizes
- Machine wash on cold gentle cycle and tumble dry, no heat
- Custom sizes available (call for quote; restrictions may apply)



Tapestries

Item #	Description	Product Wt.	1	2-5	6-11	12-24
325200	51" x 60"	0.3 lb.	56.60	54.90	53.20	51.50
325201	68" x 80"	0.5 lb.	81.80	79.35	76.90	74.45
325202	88" x 104"	0.8 lb.	107.00	103.80	100.60	97.40

USD MSRP (C)

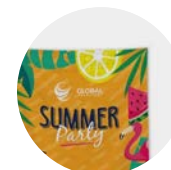

Tapestries are lightweight and easy to hang; hanging hardware not included.

AFTER FINAL PROOF APPROVAL
PRODUCTION LEAD TIME IS
2DAYS

Prices are subject to change; visit our website for the most current pricing.
Setup fee: \$20.00(G).
See pages 208-211 for additional information that may apply to your order.

Suggested Uses

- Cafeterias
- Retail Spaces
- Banks
- Bookstores

WALL DECAL

Transform any wall in seconds with this easy to apply wall decal.

- Peel and stick for easy installation
- Low-tack adhesive removes without leaving residue; easy to reposition
- Decals work on smooth, flat, painted drywall surfaces
- Vibrant colors pop on 6 mil opaque matte white vinyl
- Spot clean with mild soap and water



Wall Decal

Item #	Description	Product Wt.	1	2-5	6-11	12-24
325220	16" x 20"	0.16 lb.	50.35	48.85	47.35	45.80
325221	18" x 24"	0.23 lb.	56.60	54.90	53.20	51.50
325222	20" x 30"	0.32 lb.	62.95	61.05	59.15	57.30
325223	24" x 24"	0.3 lb.	69.20	67.10	65.05	62.95
325224	24" x 36"	0.45 lb.	75.50	73.25	70.95	68.70
325225	30" x 40"	0.62 lb.	81.80	79.35	76.90	74.45

USD MSRP (C)

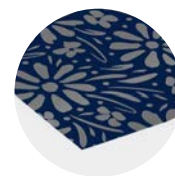

Easily remove from backing to adhere to your wall.



REMOVABLE WALLPAPER

Reinvent your space with this Removable Wallpaper!

- Artwork is vibrantly printed on PVC-free wallpaper
- Easy to apply and removes without leaving residue
- Available in two sizes
- Indoor use only
- Slight weave texture and matte finish helps cover surface imperfections
- Wallpaper panels are reinforced with synthetic fibers for durability
- Panels have a 1/4" overlap for graphic alignment; professional installation recommended
- Custom sizes available (call for quote; restrictions may apply)
- Clean with damp towel, mild dish soap and water; no ammonia products



Removable Wallpaper

Item #	Description	Product Wt.	1	2-5	6-11	12-24
281330	24"W x 9'H	1 lb.	80.00	77.60	76.80	76.00
281331	24"W x 12'H	1.25 lbs.	100.00	97.00	96.00	95.00

USD MSRP (C)

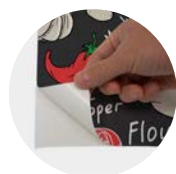

Wallpaper is easily removed from backing to adhere to your wall.



Enhance the vibe of your home or business.



Prices are subject to change; visit our website for the most current pricing.
Setup fee: \$20.00(G).
See pages 208-211 for additional information that may apply to your order.

AFTER FINAL PROOF APPROVAL
PRODUCTION LEAD TIME IS
2DAYS

TABLETOP DISPLAYS

When choosing a tabletop display
have you considered...

- **SIZE** - What is the size of your table?
- **FLEXIBILITY** - Will you be changing the message frequently?
- **FREQUENCY** - How often will you be using the display?
- **TRANSPORT** - How will this display be transported?



Suggested Uses

Trade Shows
Meetings
Museums
Hospitality

SPLASH TABLETOP DISPLAY

This display assembles in minutes and is easily transportable between events.

- Lightweight aluminum frame
- Hook-and-loop fasteners make graphic panel installation simple
- Graphic panel available in recycled polyester knit or block-out fabric
- Recycled polyester knit is a 100% recycled media made with REPREVE® fibers
- Available in straight or curved versions
- Floor display kits also available (see pages 180-181)
- US Patent #9214104



NEW
RECYCLED
POLYESTER
KNIT



Straight face kit on a
6' Standard throw shown in yellow
(sold separately; see page 14)



Curved wrap kit on a
6' Standard throw shown in yellow
(sold separately; see page 14)

Straight Splash Tabletop Display

Item #	Description	1	2-5	6-11	12-24
341000	6' Recycled Polyester Knit Face Kit	804.50	772.50	748.00	708.00
342226	6' Block-Out Fabric Face Kit	905.00	880.00	850.00	825.00
341001	6' Recycled Polyester Knit Wrap Kit	988.00	948.50	919.00	869.50
342227	6' Block-Out Fabric Wrap Kit	1090.00	1065.00	1035.00	1010.00

Kit Includes: Frame, Graphic Panel and Soft Carry Case USD MSRP (C)

Curved Splash Tabletop Display

Item #	Description	1	2-5	6-11	12-24
341012	6' Recycled Polyester Knit Face Kit	804.50	772.50	748.00	708.00
342230	6' Block-Out Fabric Face Kit	905.00	880.00	850.00	825.00
341013	6' Recycled Polyester Knit Wrap Kit	988.00	948.50	919.00	869.50
342231	6' Block-Out Fabric Wrap Kit	1090.00	1065.00	1035.00	1010.00

Kit Includes: Frame, Graphic Panel and Soft Carry Case USD MSRP (C)

Description	Product Size	Finished Graphic Size	Product Wt. (Face / Wrap)
Straight	61"W x 61"H x 14"D	View Online Template	10.5 lbs. / 11 lbs.
Curved	56"W x 61"H x 18"D	View Online Template	10.5 lbs. / 11 lbs.

BLOCK-OUT FABRIC

Block-out fabric is designed to prevent light from showing through the display. It is a good option for brightly lit areas.

RECYCLED POLYESTER KNIT

Sustainable recycled polyester knit is made with REPPEVE® fibers recycled from plastic bottles.

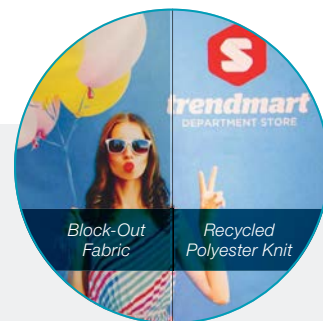

High-grade aluminum frame with bayonet locking system keeps the display stable.



Graphic panels install using hook-and-loop fasteners.

Prices are subject to change; visit our website for the most current pricing.
Setup fee: \$20.00(G).
See pages 208-211 for additional information that may apply to your order.

AFTER FINAL PROOF APPROVAL
PRODUCTION LEAD TIME IS
4 DAYS

MICRO GEOMETRIX DISPLAY

Create a variety of multidimensional displays in seconds with the Micro GeoMetrix display.

- Lightweight aluminum frame with plastic hubs
- Artwork is dye sublimated on polyester double knit
- Additional kits, graphic panels and hardware available online



Suggested Uses

- Trade Shows
- Presentations
- Job Fairs
- Meetings

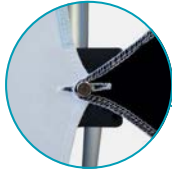

Micro GeoMetrix pegs hold up to three panels each.

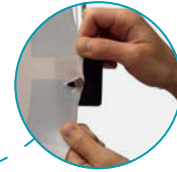

Buttonholes are reinforced with white stitching to prevent tearing.

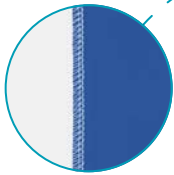

Graphic panels are finished with white stitching.



Turn your display into a product merchandiser with the Micro GeoMetrix shelf (sold separately).

Custom configuration shown with two shelves on a 6' Stain Resistant throw shown in navy blue and 57" LazerLine runner shown in mulberry (shelves, throw and runner sold separately)



Micro GeoMetrix Column

Item #	Description	1	2-5	6-11	12-24
337201	Kit	237.90	228.40	221.20	209.40
Kit Includes: Three-Quad Vertical Frame, 3 Graphic Panels and Soft Carry Case		USD MSRP (C)			
Product Size	Finished Graphic Size	Product Wt.	Media		
16.62"W x 46.75"H x 9.62"D	View Online Template	4 lbs.	Polyester Double Knit		



Micro GeoMetrix Grid

Item #	Description	1	2-5	6-11	12-24
337205	Kit	447.00	429.00	415.75	393.25
Kit Includes: Six-Quad Horizontal Frame, 6 Graphic Panels and Soft Carry Case		USD MSRP (C)			
Product Size	Finished Graphic Size	Product Wt.	Media		
46"W x 32.12"H x 9.62"D	View Online Template	6.5 lbs.	Polyester Double Knit		



Micro GeoMetrix Centerpoint

Item #	Description	1	2-5	6-11	12-24
337211	Kit	648.50	622.50	603.00	570.50
Kit Includes: Twelve-Quad Horizontal Frame, 8 Graphic Panels and Soft Carry Case		USD MSRP (C)			
Product Size	Finished Graphic Size	Product Wt.	Media		
60.75"W x 46.75"H x 9.62"D	View Online Template	12.5 lbs.	Polyester Double Knit		



Micro GeoMetrix Classic

Item #	Description	1	2-5	6-11	12-24
337207	Kit	516.00	495.50	480.00	454.00
Kit Includes: Nine-Quad Square Frame, 5 Graphic Panels and Soft Carry Case		USD MSRP (C)			
Product Size	Finished Graphic Size	Product Wt.	Media		
46"W x 46.75"H x 9.62"D	View Online Template	9.25 lbs.	Polyester Double Knit		

Add-Ons

Micro GeoMetrix Shelf

Item #	Description	1	2-5	6-11	12-24
338069	Internal Clear Shelf	45.43	43.61	42.25	39.98
Each shelf supports up to 5 lbs. Compatible with frames equipped with locking arms only.		USD MSRP (C)			



Ultimate LED Single or Double Light Kit
Item #150120 & 150121
See Page 201

AFTER FINAL PROOF APPROVAL
PRODUCTION LEAD TIME IS
4 DAYS

HARDWARE-ONLY LEAD TIME: SHIPS SAME DAY WHEN ORDERED BEFORE 2 PM CENTRAL

Prices are subject to change; visit our website for the most current pricing.
Setup fee: \$20.00(G).
See pages 208-211 for additional information that may apply to your order.

MICRO GEOMETRIX GRAPHIC PANELS

Graphic panels can be ordered separately so you can create a look that's uniquely yours.

- Designed to attach to frame at specific angles (shown below)
- Artwork is dye sublimated on polyester double knit
- Graphic panels are finished with white stitching
- Hardware sold separately (complete frames only; see website for details)



Micro GeoMetrix Graphic Panels

Item #	Description	1
337009	Graphic Panel A	72.95
337010	Graphic Panel B	72.95
337011	Graphic Panel C	72.95
337012	Graphic Panel D	86.85
337013	Graphic Panel E	86.85
337014	Graphic Panel F	117.10
337015	Graphic Panel G	86.85
337016	Graphic Panel H	100.70
337017	Graphic Panel I	86.85
337018	Graphic Panel J	100.70
337019	Graphic Panel K	100.70

Micro GeoMetrix pegs hold up to 3 panels each. USD MSRP (C)
View online templates for finished graphic sizes.

Graphic panels shown on partial frames for illustrative purposes only.
Partial frames not available for purchase.

MICRO GEOMETRIX BACK WALL

Block out distractions with a stylish backdrop.

- Stretches over nine-quad or twelve-quad Micro GeoMetrix frame (Micro GeoMetrix frames sold separately; available online)
- Artwork is dye sublimated on polyester double knit
- Printed on one side of the fabric only



Micro GeoMetrix Back Wall

Item #	Description	1	2-5	6-11	12-24
337240	Nine-Quad Back Wall	297.00	285.00	276.25	261.25
337241	Twelve-Quad Back Wall	407.75	391.50	379.25	358.75

Micro GeoMetrix pegs hold up to 3 panels each. USD MSRP (C)
View online templates for finished graphic sizes.

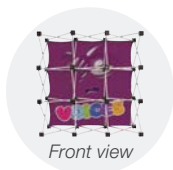

Back wall is printed single-sided with the reverse image showing through the back.



Nine-quad back wall on a Micro GeoMetrix nine-quad square frame (sold separately)

Prices are subject to change; visit our website for the most current pricing.
Setup fee: \$20.00(G).
See pages 208-211 for additional information that may apply to your order.

AFTER FINAL PROOF APPROVAL
PRODUCTION LEAD TIME IS
4 DAYS

Suggested Uses

- Point of Purchase
- In-Store Demos
- Meetings
- Charity Events



3'W x 4'H and 3'W x 2'H kits on a 6' Standard throw shown in grape (sold separately; see page 14)

NEW SIZES

NEW RECYCLED POLYESTER KNIT

EUROFIT TABLETOP STRAIGHT WALL

These six popular tabletop options feature everything you love about the EuroFit Straight Wall.

- Artwork is dye sublimated on recycled polyester knit
- 100% recycled media is made with REPREVE® fibers
- Fabric contours to the frame for a form-fitted look
- Lightweight aluminum frame
- Double-sided graphic cover slips over the frame like a pillowcase
- Push-button connectors make assembly a snap
- Floor display kits also available (see pages 162-165)



2'H EuroFit Tabletop Straight Wall

Item #	Description	1	2-5	6-11	12-24
254620	2'W Kit	170.00	163.20	158.10	149.60
254623	3'W Kit	210.00	201.60	195.30	184.80
254626	6'W Kit	265.00	254.50	246.50	233.25

Kit Includes: Hardware, Graphic Cover, EuroFit Connector and Soft Carry Case

USD MSRP (C)

Description	Product Size	Finished Graphic Size	Product Wt.	Media
2'W	24.25"W x 25.375"H x 11.75"D	View Online Template	4.2 lbs.	Recycled Polyester Knit
3'W	36.25"W x 25.375"H x 11.75"D	View Online Template	5 lbs.	Recycled Polyester Knit
6'W	72.25"W x 25.375"H x 11.75"D	View Online Template	7 lbs.	Recycled Polyester Knit

4'H EuroFit Tabletop Straight Wall

Item #	Description	1	2-5	6-11	12-24
254603	2'W Kit	210.20	201.80	195.40	184.90
254606	3'W Kit	269.50	258.50	250.50	237.00
254615	6'W Kit	529.00	508.00	492.00	465.50

Kit Includes: Hardware, Graphic Cover, EuroFit Connector and Soft Carry Case

USD MSRP (C)

Description	Product Size	Finished Graphic Size	Product Wt.	Media
2'W	24.375"W x 49.5"H x 11.75"D	View Online Template	6.2 lbs.	Recycled Polyester Knit
3'W	36.5"W x 49.5"H x 11.75"D	View Online Template	7.6 lbs.	Recycled Polyester Knit
6'W	72.25"W x 49.5"H x 11.75"D	View Online Template	9.8 lbs.	Recycled Polyester Knit



Hinge together multiple EuroFit displays with the included EuroFit Connector.

US Patent #9637963

AFTER FINAL PROOF APPROVAL PRODUCTION LEAD TIME IS **4 DAYS**

Prices are subject to change; visit our website for the most current pricing. Setup fee: \$20.00(G).

See pages 208-211 for additional information that may apply to your order.

ENVIRO BOARD

A lightweight and eco-friendly display that is perfect for limited use!

- Artwork is printed on paper-based media
- 100% recyclable
- Base is constructed of corrugated cardboard
- Available in single- and double-sided options



Enviro Board

Item #	Description	1	2-5	6-11	12-24
254740	Single-Sided Kit	45.00	43.20	41.85	39.60
254741	Double-Sided Kit	50.00	48.00	46.50	44.00

Kit Includes: Hardware and Single- or Double-Sided Graphic USD MSRP (C)

Product Size	Finished Graphic Size	Product Wt.	Media
24.125"W x 36.25"H x 12.25"D	24"W x 36"H	2.4 lbs.	Paper-Based Media



A lightweight and 100% recyclable display.

OVER-THE-TOP DISPLAY

Create an overhead banner or a stylish backdrop by simply clamping this display to a table.

- Artwork is dye sublimated on recycled polyester knit
- 100% recycled media is made with REPREVE® fibers
- Double-sided cover is viewable from both the front and back of the display
- Lightweight, durable carbon composite poles with aluminum corners



Over-The-Top Display

Item #	Description	1	2-5	6-11	12-24
280320	6' Header Kit	510.00	489.50	474.00	448.50
280321	8' Header Kit	531.00	510.00	494.00	467.50
280322	6' Short Back Wall Kit	535.00	513.50	497.50	471.00
280323	8' Short Back Wall Kit	572.50	549.50	532.50	504.00
280324	6' Tall Back Wall Kit	572.50	549.50	532.50	504.00
280325	8' Tall Back Wall Kit	598.00	574.00	556.00	526.00
280331	Floor Base with Pole Post (Set of 2)	117.10	112.40	108.90	103.00

Kit Includes: Frame, Graphic Cover and Soft Carry Case USD MSRP (C)

Description	Product Size	Finished Graphic Size	Product Wt.	Media
6' Header	74.5"W x 44" or 68.25"H x 2.875"D	View Online Template	9.75 lbs.	Recycled Polyester Knit
8' Header	98"W x 44" or 68.25"H x 2.875"D	View Online Template	10 lbs.	Recycled Polyester Knit
6' Short Back Wall	74.5"W x 44"H x 2.875"D	View Online Template	11 lbs.	Recycled Polyester Knit
8' Short Back Wall	98"W x 44"H x 2.875"D	View Online Template	11.75 lbs.	Recycled Polyester Knit
6' Tall Back Wall	74.5"W x 68.25"H x 2.875"D	View Online Template	12 lbs.	Recycled Polyester Knit
8' Tall Back Wall	98"W x 68.25"H x 2.875"D	View Online Template	13.25 lbs.	Recycled Polyester Knit



6' Header kit on a 6' UltraFit Curve throw (sold separately; see page 20)



The easy-to-use clamp system attaches to any table up to 2.5" thick. No tools required.

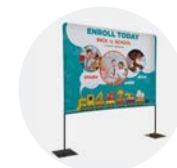

Use as a freestanding display by adding floor bases (sold separately).

Kit Options



Header Short Back Wall Tall Back Wall
Shown on an UltraFit throw (sold separately). Table not included.

HARDWARE-ONLY LEAD TIME: SHIPS SAME DAY WHEN ORDERED BEFORE 2 PM CENTRAL

Prices are subject to change; visit our website for the most current pricing.
Setup fee: \$20.00(G).
See pages 208-211 for additional information that may apply to your order.

ENVIRO OVER-THE-TOP
AFTER FINAL PROOF APPROVAL
PRODUCTION LEAD TIME IS
24 DAYS

Suggested Uses

- College Recruiting
- Trade Shows
- Sales Meetings
- Presentations



6' display with full graphics on a 6' Standard throw shown in shamrock (sold separately; see page 14)

FABRIC COLORS

- Blue PMS 287
- Black
- Gray PMS 430

FAST TRAK DISPLAY

Create an eye-catching presentation with this popular, lightweight display.

- Display can be used with graphic panels on both sides
- Hook-and-loop receptive fabric makes graphic panel changes quick and easy
- Seamless design with hidden double-acting hinges
- Available in 4' or 6' sizes
- Easy clip-on header



Fast Trak Display

Item #	Description	1	2-5	6-11	12-24
146084	4' Display Only	400.25	384.25	372.25	352.25
146011	4' Display with Header Graphic Panel	475.75	456.75	442.50	418.75
146012	4' Display with Full Graphic Panels	773.00	745.00	715.00	682.00
146085	6' Display Only	447.00	429.00	415.75	393.25
146014	6' Display with Header Graphic Panel	536.50	515.00	499.00	472.00
146015	6' Display with Full Graphic Panels	927.50	893.50	857.50	818.00

USD MSRP (C)

Graphic Panels

Item #	Description	1	2-5	6-11	12-24
190015	4' Header Graphic Panel	75.55	72.55	70.25	66.50
190013	6' Header Graphic Panel	89.40	85.80	83.15	78.65
190017	4' Body Graphic Panel	103.20	99.10	96.00	90.80
190014	6' Body Graphic Panel	135.80	130.40	126.30	119.50

USD MSRP (C)

Description	Product Size	Body Graphic Panel Size	Header Graphic Panel Size	Product Wt.	Media
4'	54"W x 37"H x 22"D	17"W x 27.5"H	17"W x 7"H	10 lbs.	Titan™ No-Curl Laminated Media
6'	72"W x 48"H x 22"D	23"W x 34.75"H	22.75"W x 10.75"H	15 lbs.	Titan™ No-Curl Laminated Media

Display Options



DISPLAY-ONLY (NO GRAPHICS) LEAD TIME: SHIPS SAME DAY WHEN ORDERED BEFORE 2 PM CENTRAL

AFTER FINAL PROOF APPROVAL
PRODUCTION LEAD TIME IS
3 DAYS

Prices are subject to change; visit our website for the most current pricing.
Setup fee: \$20.00(G).
See pages 208-211 for additional information that may apply to your order.

DYNAMO TRIFECTA DISPLAY

Lightweight and affordable, this display is perfect for the budget-conscious marketer.

- Double-acting fabric hinges
- Graphic panels can be applied to hook-and-loop-receptive fabric
- Available in 4' or 6' sizes
- Easy to fold for transportation and storage

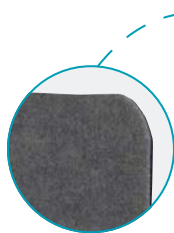

Frameless display has rounded corners.



6' display with graphic panels on a 6' Standard throw shown in navy blue (sold separately; see page 14)

Dynamo Trifecta Display

Item #	Description	1	2-5	6-11	12-24
141007	4' Display Only	196.30	188.40	182.60	172.70
141009	4' Display with Graphic Panels	453.75	437.75	418.50	400.75
141008	6' Display Only	225.30	216.30	209.50	198.30
141010	6' Display with Graphic Panels	616.50	595.00	568.00	544.50

USD MSRP (C)

Graphic Panels

Item #	Description	1	2-5	6-11	12-24
190023	4' Body Graphic Panel	89.40	85.80	83.15	78.65
190014	6' Body Graphic Panel	135.80	130.40	126.30	119.50

USD MSRP (C)

Description	Product Size	Finished Graphic Size	Product Wt.	Media
4'	54"W x 24"H x 22"D	17"W x 23"H	5 lbs.	Titan™ No-Curl Laminated Media
6'	72"W x 36"H x 22"D	23"W x 34.75"H	10 lbs.	Titan™ No-Curl Laminated Media

FABRIC COLORS



Blue PMS 2728



Black



Gray PMS 422

SHOW 'N WRITE DISPLAY

This unique display features hook-and-loop-receptive fabric on one side and dry-erase board on the other, giving you limitless possibilities.

- Graphic panels can be applied to hook-and-loop-receptive fabric
- Available in 4' or 6' sizes
- Lightweight and portable



Plastic frame has rounded corners.



6' display with custom configuration graphic panels on a 6' Standard throw shown in flamingo (sold separately; see page 14)

Show 'N Write Display

Item #	Description	1	2-5	6-11	12-24
142004	4' Display Only	372.50	357.50	346.50	327.75
142006	4' Display with Graphic Panels	705.50	679.50	652.50	622.50
142007	6' Display Only	447.00	429.00	415.75	393.25
142009	6' Display with Graphic Panels	927.50	893.50	857.50	818.00

USD MSRP (C)

Graphic Panels

Item #	Description	1	2-5	6-11	12-24
190015	4' Header Graphic Panel	75.55	72.55	70.25	66.50
190013	6' Header Graphic Panel	89.40	85.80	83.15	78.65
190023	4' Body Graphic Panel	89.40	85.80	83.15	78.65
190014	6' Body Graphic Panel	135.80	130.40	126.30	119.50

USD MSRP (C)

Description	Product Size	Finished Graphic Size	Product Wt.	Media
4'	54"W x 24"H x 22"D	17"W x 23"H	5 lbs.	Titan™ No-Curl Laminated Media
6'	72"W x 36"H x 22"D	23"W x 34.75"H	10 lbs.	Titan™ No-Curl Laminated Media

FABRIC COLORS



Blue PMS 2728

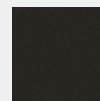

Black



Gray PMS 422

DISPLAY-ONLY (NO GRAPHICS) LEAD TIME: SHIPS SAME DAY WHEN ORDERED BEFORE 2 PM CENTRAL

Prices are subject to change; visit our website for the most current pricing.

Setup fee: \$20.00(G).

See pages 208-211 for additional information that may apply to your order.

AFTER FINAL PROOF APPROVAL
PRODUCTION LEAD TIME IS
3 DAYS

NEW
DRY-ERASE
MEDIA



24" Economy



18" Economy



Deluxe Mini



Small Mini Promo



Large Mini Promo



18" & 24" Economy hardware available in silver or black.



Flip-open base discretely hides the pole and banner when not in use.



Lightweight aluminum base has a small footprint.

MINI RETRACTORS

These mini retractors can be used even when space is limited.

- Compact size
- Lightweight and portable
- Warranties range between six months and one year (see Retractable Banner Comparison Chart on page 29 for details)



Mini Promo Retractor

Item #	Description	1	2-5	6-11	12-24
210240	Small Kit	58.50	56.15	54.40	51.50
210242	Large Kit	65.40	62.80	60.80	57.55

Kit Includes: Hardware and Installed Graphic

USD MSRP (C)

Deluxe Mini Retractor

Item #	Description	1	2-5	6-11	12-24
262014	Kit	75.55	72.55	70.25	66.50

Kit Includes: Hardware and Installed Graphic

USD MSRP (C)

Description	Product Size	Finished Graphic Size	Product Wt.	Media
Deluxe Mini	9.375"W x 17.75"H x 4"D	8.25"W x 16.25"H	1.5 lbs.	Titan™ Polypropylene Media
Small Mini Promo	9.625"W x 13.25"H x 3"D	8.25"W x 12"H	1 lb.	Titan™ Polypropylene Media
Large Mini Promo	13.125"W x 17.875"H x 3"D	11.5"W x 16.5"H	1 lb.	Titan™ Polypropylene Media

Economy Tabletop Retractor

Item #	Description	1	2-5	6-11	12-24
261380	18" Tabletop No-Curl Hybrid Media Kit	145.60	136.90	131.10	122.30
261381	18" Tabletop No-Curl Opaque Fabric Kit	145.60	136.90	131.10	122.30
261382	18" Tabletop PVC-Free Silver Backed Media Kit	145.60	136.90	131.10	122.30
261430	18" Tabletop Dry-Erase Media Kit	145.60	136.90	131.10	122.30
261130	24" Tabletop No-Curl Hybrid Media Kit	178.30	167.60	160.50	149.80
262160	24" Tabletop No-Curl Opaque Fabric Kit	178.30	167.60	160.50	149.80
261360	24" Tabletop PVC-Free Silver Backed Media Kit	178.30	167.60	160.50	149.80
261431	24" Tabletop Dry-Erase Media Kit	178.30	167.60	160.50	149.80

Kit Includes: Black or Silver Hardware, Installed Graphic and Soft Carry Case

Description	Product Size	Finished Graphic Size	Product Wt.	Media
18" Economy	19"W x 28"H x 11"D	View Online Template	5.4 lbs.	See Kit Description
24" Economy	24.75"W x 39"H x 11"D	View Online Template	5.5 lbs.	See Kit Description

AFTER FINAL PROOF APPROVAL
PRODUCTION LEAD TIME IS
2DAYS

Prices are subject to change; visit our website for the most current pricing.
Setup fee: \$20.00(G).

See pages 208-211 for additional information that may apply to your order.

NEW
RECYCLED
POLYESTER
KNIT

NEW
STICK FLAG
BASES



Aluminum frame features push-button connections and square plastic corners.



X-shaped frame features four tension rods that keep the banner taut.



Base available with 1, 2 or 3 holes (4" x 6" Stick Flags sold separately; see page 81).



Double-sided flags feature a lightweight block-out polyester.



X-shaped hardware design gives the display its structure.

MINI DISPLAYS

These displays fit into small areas, making them perfect for tables and countertops.

- Lightweight and portable
- Warranties range between 30 days and one year (see website for details)



EuroFit Mini Display

Item #	Description	1	2-5	6-11	12-24
280370	Kit	97.30	93.40	90.45	85.65

Kit Includes: Hardware, Graphic Cover and Soft Carry Case USD MSRP (C)

Micro Teardrop Sail Sign

Item #	Description	1	5	6-11	12-24
191540	Single-Sided Kit	NA	54.00	52.40	49.70
191541	Double-Sided Kit	NA	86.70	84.10	79.75

Kit Includes: Hardware, Graphic and Carry Pouch USD MSRP (C)

Mini X Banner Display

Item #	Description	1	2-5	6-11	12-24
210032	Kit	37.62	36.12	34.99	33.11

Kit Includes: Hardware, Graphic and Drawstring Pouch USD MSRP (C)

Description	Product Size	Finished Graphic Size	Product Wt.	Media
EuroFit Mini	12.875"W x 18.625"H x 11"D	View Online Template	2.25 lbs.	Recycled Polyester Knit
Micro Teardrop	9"W x 17.5"H x 3.125"D	View Online Template	3.9 oz.	See Website
Mini X	11.75"W x 18"H x 10.75"D	11"W x 17"H	0.5 lb.	Titan™ No-Curl Laminated Media

Xpress Tabletop Banner Display

Item #	Description	1	2-5	6-11	12-24
264360	24"W x 35"H Kit	119.60	114.80	111.20	105.20
264361	35"W x 24"H Kit	119.60	114.80	111.20	105.20

Kit Includes: Hardware, Graphic and Drawstring Pouch USD MSRP (C)

Stick Flag Base

Item #	Description	1	2-5	6-11	12-24
304757	Base for One 4" x 6" Stick Flag	2.45	2.25	2.11	1.96
304758	Base for Two 4" x 6" Stick Flags	3.47	3.19	2.98	2.78
304759	Base for Three 4" x 6" Stick Flags	3.47	3.19	2.98	2.78

Base only. Stick Flags sold separately (see page 81). USD MSRP (C)

Description	Product Size	Finished Graphic Size	Product Wt.	Media
24"W x 35"H Xpress	24.5"W x 34.5"H x 14"D	View Online Template	1.4 lbs.	Two-Way Stretch Fabric
35"W x 24"H Xpress	34.5"W x 24.5"H x 18.25"D	View Online Template	1.4 lbs.	Two-Way Stretch Fabric
Stick Flag Base	2.5"W x 11"H x 2.5"D	NA	0.25 lb.	NA

HARDWARE-ONLY LEAD TIME: SHIPS SAME DAY WHEN ORDERED BEFORE 2 PM CENTRAL

Prices are subject to change; visit our website for the most current pricing.
Setup fee: \$20.00(G).
See pages 208-211 for additional information that may apply to your order.

MINI X
24 OR **2** DAYS
AFTER FINAL PROOF APPROVAL
PRODUCTION LEAD TIME IS

FLOOR DISPLAYS

When choosing a floor display **have you considered...**

- **SIZE** - What is the size of your space?
- **FREQUENCY** - How often will you be setting up and taking down your display?
- **TRANSPORT** - How will this display be transported?
- **FLEXIBILITY** - Will you be changing out your look and message frequently?
- **ACCESSORIES** - Do you need lights for your display, and will power be available?

FLOOR DISPLAYS



1

FLOOR DISPLAYS



2



FLOOR DISPLAYS

3

EUROFIT DISPLAYS

VERSATILE. MODULAR. CONNECTED.

FLOOR DISPLAYS

NEW
RECYCLED
POLYESTER
KNIT

NEW
BIO-
DEGRADABLE
MEDIA
see page 165

Personalize your display by adding accessories (sold separately; see page 166).

Slim swivel feet allow units to be paired at angles.

Fabric contours to the frame for a form-fitted look.

Tubular aluminum frame is lightweight and stable.

EUROFIT FEATURES & BENEFITS



Joints are labeled for accurate step-by-step frame assembly.



Push-button connectors make assembly easy.



Select displays feature a heavy-duty zipper that secures the graphic cover.

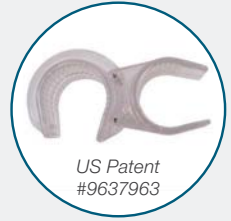

US Patent #9637963

Compatible displays can be hinged together using the EuroFit Connector.



Soft carry case included with all kits.

EASE OF SETUP

Double-sided graphic covers easily slide on and off.



EUROFIT WALLS WITH RECYCLED POLYESTER KNIT

The ever-popular EuroFit line offers many elegant and versatile display solutions.

- Artwork is dye sublimated on recycled polyester knit
- 100% recycled media is made with REPREVE® fibers
- Double-sided graphic cover is viewable from both the front and back of the display



54"H EuroFit Straight Wall with Recycled Polyester Knit

Item #	Description	1	2-5	6-11	12-24
256200	2'W Kit	225.00	218.00	212.00	204.00
256209	3'W Kit	283.00	274.00	266.00	258.00
256218	4'W Kit	346.00	335.00	325.00	315.00
256227	5'W Kit	415.00	402.00	390.00	377.00
256236	8'W Kit	576.00	559.00	541.00	524.00

Kit Includes: Hardware, Graphic Cover, EuroFit Connector and Soft Carry Case USD MSRP (C)

Description	Product Size	Finished Graphic Size	Product Wt.
2'W	24.5"W x 54"H x 19"D	View Online Template	6.6 lbs.
3'W	36.5"W x 54"H x 19"D	View Online Template	7.5 lbs.
4'W	48.5"W x 54"H x 19"D	View Online Template	8.25 lbs.
5'W	60.5"W x 54"H x 19"D	View Online Template	9.25 lbs.
8'W	96.5"W x 54"H x 19"D	View Online Template	13.8 lbs.

72"H EuroFit Straight Wall with Recycled Polyester Knit

Item #	Description	1	2-5	6-11	12-24
256203	2'W Kit	262.00	254.00	247.00	238.00
256212	3'W Kit	346.00	332.00	319.00	299.00
256221	4'W Kit	438.00	425.00	412.00	399.00
256230	5'W Kit	545.00	528.00	513.00	496.00
255650	6'W Kit	650.00	630.00	612.00	592.00
256239	8'W Kit	737.00	714.00	693.00	670.00

Kit Includes: Hardware, Graphic Cover, EuroFit Connector and Soft Carry Case USD MSRP (C)

Description	Product Size	Finished Graphic Size	Product Wt.
2'W	24.5"W x 72"H x 19"D	View Online Template	7.5 lbs.
3'W	36.5"W x 72"H x 19"D	View Online Template	8.25 lbs.
4'W	48.5"W x 72"H x 19"D	View Online Template	9.5 lbs.
5'W	60.5"W x 72"H x 19"D	View Online Template	11 lbs.
6'W	72.5"W x 72"H x 19"D	View Online Template	11.2 lbs.
8'W	96.5"W x 72"H x 19"D	View Online Template	15.5 lbs.

AFTER FINAL PROOF APPROVAL
PRODUCTION LEAD TIME IS
4DAYS

Prices are subject to change; visit our website for the most current pricing.
Setup fee: \$20.00(G).
See pages 208-211 for additional information that may apply to your order.

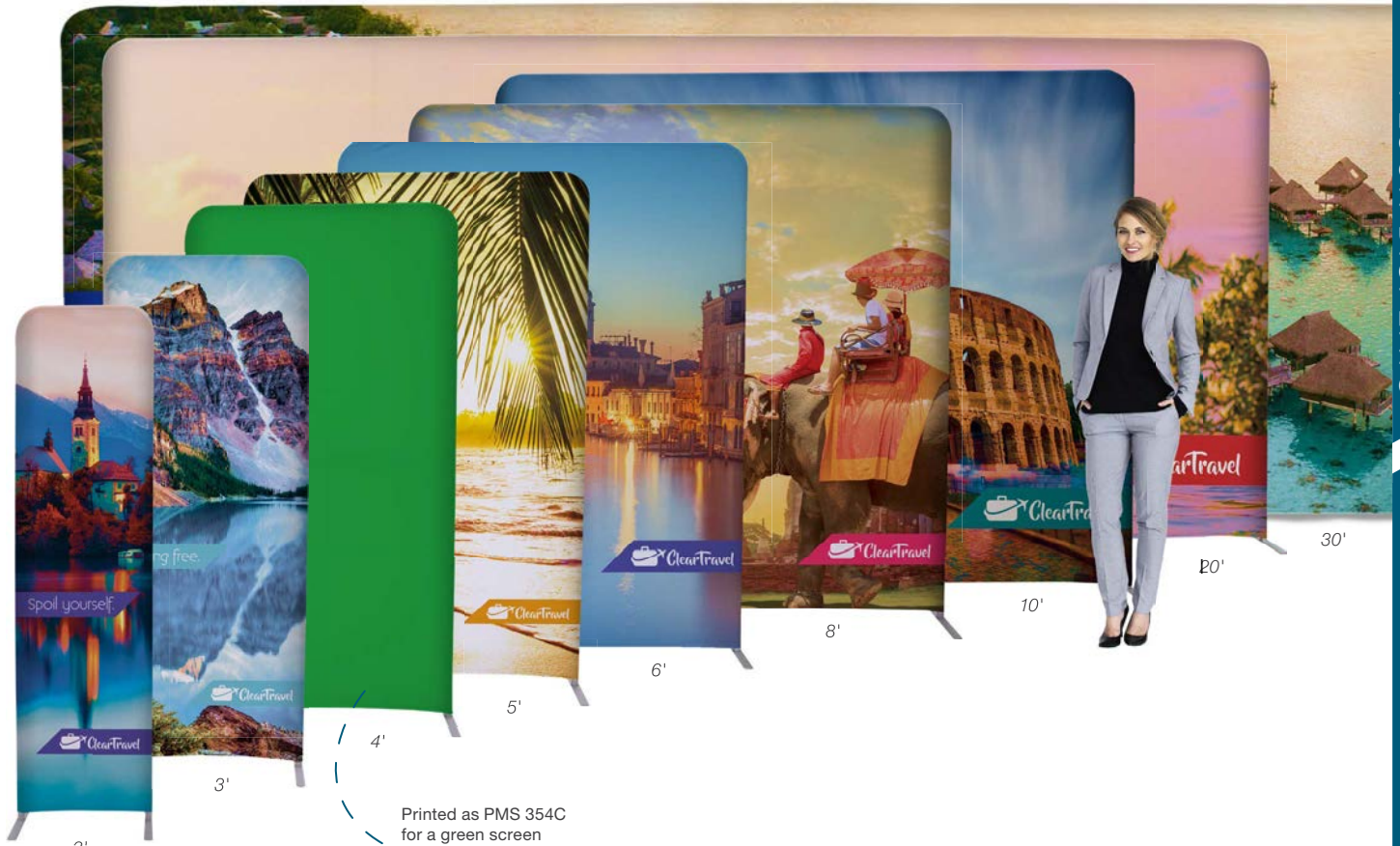

Printed as PMS 354C for a green screen compatible backdrop. Available in 4'W and 5'W.

90"H EuroFit Straight Wall with Recycled Polyester Knit

Item #	Description	1	2-5	6-11	12-24
256206	2'W Kit	311.00	302.00	293.00	283.00
256215	3'W Kit	418.00	405.00	393.00	380.00
256224	4'W Kit	545.00	528.00	513.00	496.00
456520	4'W Green Screen Kit	545.00	528.00	513.00	496.00
256233	5'W Kit	630.00	612.00	592.00	574.00
456522	5'W Green Screen Kit	630.00	612.00	592.00	574.00
255657	6'W Kit	715.00	693.00	672.00	651.00
255180	8'W Kit	957.00	928.00	899.00	871.00
256251	10'W Kit	1680.00	1645.00	1595.00	1565.00
256427	20'W Kit	3305.00	3265.00	3145.00	3105.00
256424	30'W Kit	4959.00	4809.00	4719.00	4584.00

Kit Includes: Hardware, Graphic Cover, EuroFit Connector and Soft Carry Case
 20' Display Includes: Hardware, Graphic Cover, 2 EuroFit Connectors and 2 Soft Carry Cases
 30' Display Includes: Hardware, Graphic Cover, 6 EuroFit Connectors and 3 Soft Carry Cases
 USD MSRP (C)

Description	Product Size	Finished Graphic Size	Product Wt.
2'W	24.5"W x 91.25"H x 19"D	View Online Template	9.25 lbs.
3'W	36.5"W x 91.25"H x 19"D	View Online Template	10.3 lbs.
4'W	48.5"W x 91.25"H x 19"D	View Online Template	11.4 lbs.
5'W	60.5"W x 91.25"H x 19"D	View Online Template	12.6 lbs.
6'W	72.5"W x 91.25"H x 19"D	View Online Template	13.4 lbs.
8'W	96.5"W x 91.25"H x 19"D	View Online Template	18 lbs.
10'W	115.5"W x 91.25"H x 19"D	View Online Template	21.25 lbs.
20'W	231"W x 91.25"H x 19"D	View Online Template	42.75 lbs.
30'W	346.5"W x 91.25"H x 19"D	View Online Template	64.25 lbs.



Sustainable recycled polyester knit is made with REPREVE® fibers recycled from plastic bottles.

Prices are subject to change; visit our website for the most current pricing.
 Setup fee: \$20.00(G).
 See pages 208-211 for additional information that may apply to your order.

AFTER FINAL PROOF APPROVAL
 PRODUCTION LEAD TIME IS
4 DAYS

- Sports Arenas
- Colleges
- Trade Shows
- Corporate Events



120" H EUROFIT WALLS

Our 120" H EuroFit Straight Wall towers above the rest for a magnificent display option.

- Artwork is dye sublimated on recycled polyester knit
- 100% recycled media is made with REPREVE® fibers
- Double-sided graphic cover is viewable from both the front and back of the display



120" H EuroFit Straight Wall with Recycled Polyester Knit

Item #	Description	1	2-5	6-11	12-24
256512	8' W Kit	1135.00	1115.00	1080.00	1060.00
256515	10' W Kit	1815.00	1780.00	1725.00	1690.00

Kit Includes: Hardware, Graphic Cover, EuroFit Connector and Soft Carry Case USD MSRP (C)

Description	Product Size	Finished Graphic Size	Product Wt.	Media
8' W	96" W x 119.5" H x 29" D	View Online Template	18.5 lbs.	Recycled Polyester Knit
10' W	115.25" W x 119.5" H x 29" D	View Online Template	22.5 lbs.	Recycled Polyester Knit



EUROFIT PLUS

A perfect pairing of our best-selling EuroFit Straight Walls with a Case-to-Counter for promotion on the go.

- The EuroFit Straight Wall kit is the perfect backdrop for a stunning presentation
- Recycled polyester knit is a 100% recycled media made with REPREVE® fibers
- A Case-to-Counter Conversion kit transforms the hard case into a podium



90" H EuroFit Straight Wall Plus

Item #	Description	1	2-5	6-11	12-24
256300	8' W Kit	1725.00	1674.00	1623.00	1579.00
256303	10' W Kit	2448.00	2391.00	2319.00	2273.00

Kit Includes: Hardware, Graphic Cover, EuroFit Connector, Soft Carry Case, Oval Hard Case, Oval Counter Top and UltraFit Wrap Graphic USD MSRP (C)

Description	Product Size	Finished Graphic Size	Product Wt.	Media
8' W	EuroFit: 96.5" W x 91.25" H x 19" D Case: 26.25" W x 38.5" H x 17.5" D	View Online Template	43 lbs.	EuroFit: Recycled Polyester Knit Wrap: Two-Way Stretch Fabric
10' W	EuroFit: 115.5" W x 91.25" H x 19" D Case: 26.25" W x 38.5" H x 17.5" D	View Online Template	46.75 lbs.	EuroFit: Recycled Polyester Knit Wrap: Two-Way Stretch Fabric



AFTER FINAL PROOF APPROVAL
PRODUCTION LEAD TIME IS
4 DAYS

Prices are subject to change; visit our website for the most current pricing.

Setup fee: \$20.00(G).

See pages 208-211 for additional information that may apply to your order.



EUROFIT WALLS WITH BIODEGRADABLE MEDIA

Your EuroFit Straight Walls just got better with a sustainable, biodegradable media option.

- Artwork is dye sublimated on CiCLO® treated polyester fabric
- CiCLO® treated fabric allows the polyester to biodegrade 91.1% compared to untreated polyester
- Double-sided graphic cover is viewable from both the front and back of the display



72"H EuroFit Straight Wall with Biodegradable Media

Item #	Description	1	2-5	6-11	12-24
255620	2'W Kit	307.00	297.00	289.00	279.00
255622	3'W Kit	391.00	379.00	368.00	355.00
255624	4'W Kit	483.00	469.00	454.00	440.00
255626	5'W Kit	591.00	573.00	556.00	538.00
255652	6' W Kit	690.00	669.00	649.00	628.00

Kit Includes: Hardware, Graphic Cover, EuroFit Connector and Soft Carry Case USD MSRP (C)

Description	Product Size	Finished Graphic Size	Product Wt.
2'W	24.5"W x 72"H x 19"D	View Online Template	7.5 lbs.
3'W	36.5"W x 72"H x 19"D	View Online Template	8.25 lbs.
4'W	48.5"W x 72"H x 19"D	View Online Template	9.5 lbs.
5'W	60.5"W x 72"H x 19"D	View Online Template	11 lbs.
6'W	72.5"W x 72"H x 19"D	View Online Template	11.2 lbs.

90"H EuroFit Straight Wall with Biodegradable Media

Item #	Description	1	2-5	6-11	12-24
255628	2'W Kit	356.00	345.00	335.00	324.00
255630	3'W Kit	463.00	449.00	435.00	421.00
255632	4'W Kit	591.00	573.00	556.00	538.00
255634	5'W Kit	674.00	654.00	634.00	614.00
255659	6'W Kit	755.00	732.00	709.00	687.00

Kit Includes: Hardware, Graphic Cover, EuroFit Connector and Soft Carry Case USD MSRP (C)

Description	Product Size	Finished Graphic Size	Product Wt.
2'W	24.5"W x 91.25"H x 19"D	View Online Template	9.25 lbs.
3'W	36.5"W x 91.25"H x 19"D	View Online Template	10.3 lbs.
4'W	48.5"W x 91.25"H x 19"D	View Online Template	11.4 lbs.
5'W	60.5"W x 91.25"H x 19"D	View Online Template	12.6 lbs.
6'W	72.5"W x 91.25"H x 19"D	View Online Template	13.4 lbs.



CiCLO® is a sustainable textile additive that allows synthetic media to break down at a rate similar to natural fibers.

Prices are subject to change; visit our website for the most current pricing.
Setup fee: \$20.00(G).
See pages 208-211 for additional information that may apply to your order.

AFTER FINAL PROOF APPROVAL
PRODUCTION LEAD TIME IS
4 DAYS

EUROFIT WALL ACCESSORIES



FLOOR DISPLAYS

Mounting bracket is designed to hold monitors up to 23" in size (monitor not included).

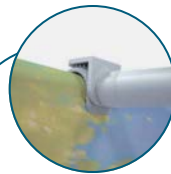

Attaches to the top of 90"H EuroFit Straight Walls using the built-in clamps.



Same push-button assembly as EuroFit Walls.



Black shelf wraps around the edge of most EuroFit displays.



MDF shelves give you space to display merchandise.



Swivel caster wheels feature brakes so they can be locked into place.

EuroFit Wall Shelf

Item #	Description	Product Wt.	1	2-5	6-11	12-24
255123	Left Shelf Kit	7.5 lbs.	163.00	158.00	153.00	148.00
255124	Right Shelf Kit	7.5 lbs.	163.00	158.00	153.00	148.00

Kit Includes: Hardware and Soft Carry Case
Each shelf supports up to 10 lbs. USD MSRP (C)

EuroFit Cascade Merchandiser

Item #	Description	Product Wt.	1	2-5	6-11	12-24
256390	Hanger Merchandiser Kit	14.4 lbs.	480.00	470.00	455.00	445.00
256391	Two-Shelf Merchandiser Kit	19 lbs.	480.00	470.00	455.00	445.00
256392	Three-Shelf Merchandiser Kit	22.5 lbs.	480.00	470.00	455.00	445.00

Kit Includes: Hardware and Soft Carry Case
Compatible with 90"H EuroFit Straight Walls (sold separately). Excludes 2"W walls.
Each shelf supports up to 5 lbs., hanger supports up to 10 lbs.
Recommended monitor size up to 23" (monitor not included). USD MSRP (C)

EuroFit Light Clamp

Item #	Description	1	2-5	6-11	12-24
255125	Light Clamp	6.80	6.60	6.40	6.20

Clamp only. Ultimate LED Light Kit sold separately; see page 201. USD MSRP (C)

EuroFit Wheeled Feet

Item #	Description	Product Wt.	1	2-5	6-11	12-24
255128	Wheeled Feet (Set of 2)	2.25 lbs.	62.90	61.00	59.10	57.20

Not compatible with 120"H EuroFit Straight Wall USD MSRP (C)

EuroFit Connector

Item #	Description	1	2-5	6-11	12-24
255122	Connector	7.30	7.10	6.90	6.60

Included with most EuroFit kits
See Kit Includes details USD MSRP (C)



EuroFit accessories shown on 90"H EuroFit Straight Walls (sold separately)

**HARDWARE SHIPS
SAME DAY**
WHEN ORDERED BEFORE 2 PM CENTRAL

Prices are subject to change; visit our website for the most current pricing.
Setup fee: \$20.00(G).
See pages 208-211 for additional information that may apply to your order.

EUROFIT VINYL WALL BARRIER

Use these lightweight, easily transportable room dividers to create separation and privacy.

- Double-sided cover constructed of Titan™ 13 oz. smooth scrim vinyl with lightweight aluminum frame
- Vinyl cover is easy to wipe clean with soap and warm water or non-alcohol-based solutions to maintain best health practices
- Available with full-color graphics to display your message or in unimprinted white
- Soft carry case is for frame transport and storage only
- Available in three widths
- Graphic cover has a 90-day warranty; hardware has a 1-year warranty



EuroFit Vinyl Wall Barrier

Item #	Description	1	2-5	6-11	12-24
256255	4'W x 72"H Full-Color Imprint Kit	356.00	345.50	336.50	326.00
256261	4'W x 72"H Unimprinted Kit	302.00	293.00	285.00	276.25
256257	5'W x 72"H Full-Color Imprint Kit	485.00	470.00	458.50	443.75
256263	5'W x 72"H Unimprinted Kit	429.00	416.00	404.00	390.00
256259	8'W x 72"H Full-Color Imprint Kit	621.00	602.00	587.00	568.00
256265	8'W x 72"H Unimprinted Kit	566.00	549.00	532.00	515.00

Kit Includes: Hardware, Cover, EuroFit Connector and Soft Carry Case USD MSRP (C)

Description	Product Size	Finished Graphic Size	Product Wt.	Media
4'	48.5"H x 72"W x 19"D	View Online Template	11.4 lbs.	Titan™ 13 oz. Scrim Vinyl
5'	60.5"H x 72"W x 19"D	View Online Template	13 lbs.	Titan™ 13 oz. Scrim Vinyl
8'	96.5"H x 72"W x 19"D	View Online Template	19.2 lbs.	Titan™ 13 oz. Scrim Vinyl



EUROFIT BOW

This double-sided display is lightweight and stylish.

- Artwork is dye sublimated on recycled polyester knit
- 100% recycled media is made with REPREVE® fibers
- Graphic cover slips over the frame like a pillowcase, then zips shut
- Heavy-duty zipper keeps the graphic cover secure and taut
- Fabric contours to the frame for a form-fitted look



EuroFit Bow

Item #	Description	1	2-5	6-11	12-24
255006	8'W Kit	1590.00	1545.00	1500.00	1455.00
255009	10'W Kit	1730.00	1685.00	1635.00	1590.00

Kit Includes: Hardware, Graphic Cover, EuroFit Connector and Soft Carry Case USD MSRP (C)

Description	Product Size	Finished Graphic Size	Product Wt.	Media
8'W	96"W x 89"H x 18"D	View Online Template	16 lbs.	Recycled Polyester Knit
10'W	120"W x 89"H x 18"D	View Online Template	18 lbs.	Recycled Polyester Knit



EUROFIT INFINITY

The EuroFit Infinity creates a fun three-dimensional display for infinite viewing angles.

- This display is approximately 10' wide
- Artwork is dye sublimated on recycled polyester knit
- 100% recycled media is made with REPREVE® fibers
- Graphic cover slips over the frame like a pillowcase, then zips shut
- Heavy-duty zipper keeps the graphic cover secure and taut
- Fabric contours to the frame for a form-fitted look



EuroFit Infinity

Item #	Description	1	2-5	6-11	12-24
255236	Kit	1845.00	1805.00	1755.00	1715.00

Kit Includes: Hardware, Graphic Cover, EuroFit Connector and Soft Carry Case USD MSRP (C)

Product Size	Finished Graphic Size	Product Wt.	Media
118.5"W x 94.5"H x 16"D	View Online Template	33.5 lbs.	Recycled Polyester Knit



Prices are subject to change; visit our website for the most current pricing. See pages 208-211 for additional information that may apply to your order.

AFTER FINAL PROOF APPROVAL
PRODUCTION LEAD TIME IS
4 DAYS



Not compatible with EuroFit Connector or other EuroFit accessories



- Suggested Uses**
- Trade Shows
 - Event Centers
 - Weddings
 - School Events

EUROFIT TRIUMPH WITH RUNNER

Make a grand entrance with this supersized display. The included runner lets you dedicate more space to your message.

- Artwork is dye sublimated on recycled polyester knit
- 100% recycled media is made with REPREEVE® fibers
- Graphic cover slips over the frame like a pillowcase, then zips shut
- Heavy-duty zipper keeps the graphic cover secure and taut
- The runner includes aluminum dowels that slip inside its pole pockets to keep it weighed down



EuroFit Triumph with Runner

Item #	Description	1	2-5	6-11	12-24
256340	Kit	2185.00	2140.00	2075.00	2030.00

Kit Includes: Hardware, Graphic Cover, Runner and Soft Carry Case USD MSRP (C)
Runner is printed single-sided.

Product Size	Finished Graphic Size	Product Wt.	Media
142.5"W x 126.75"H x 48.25"D Head Clearance: 89.5"H	View Online Template	62.2 lbs.	Recycled Polyester Knit

- Suggested Uses**
- Sporting Events
 - Athletic Clubs
 - Vendor Shows
 - Colleges



20' (not compatible with EuroFit Connector or other EuroFit accessories)

10'

EUROFIT ARCH PLUS

Combine all the ad space of an eye-catching arch with an additional front panel for even more graphic coverage.

- Artwork is dye sublimated on recycled polyester knit
- 100% recycled media is made with REPREEVE® fibers
- Graphic cover slips over the frame like a pillowcase, then zips shut
- Heavy-duty zipper keeps the graphic cover secure and taut
- Fabric contours to the frame for a form-fitted look
- Hex wrench included



EuroFit Arch Plus

Item #	Description	1	2-5	6-11	12-24
255163	10'W Kit	2015.00	1975.00	1915.00	1875.00
255165	20'W Kit	2790.00	2730.00	2650.00	2595.00

Kit Includes: Hardware, Graphic Cover, EuroFit Connector (10' Kit Only) and Soft Carry Case USD MSRP (C)

Description	Product Size	Finished Graphic Size	Product Wt.	Media
10'W	132"W x 103.75"H x 39.5"D	View Online Template	25.75 lbs.	Recycled Polyester Knit
20'W	252"W x 153"H x 39.5"D	View Online Template	56 lbs.	Recycled Polyester Knit

ARCH PLUS TRIUMPH
AFTER FINAL PROOF APPROVAL
PRODUCTION LEAD TIME IS
7 OF 4 DAYS

Prices are subject to change; visit our website for the most current pricing.
Setup fee: \$20.00(G).
See pages 208-211 for additional information that may apply to your order.



EUROFIT EVOLUTION

Prepare to steal the show with this unique extension of the EuroFit family. With an attractive incline and a vibrantly dye-sublimated graphic cover, you can see why this line is famous.

- Artwork is dye sublimated on recycled polyester knit
- 100% recycled media is made with REPREEVE® fibers
- Lightweight aluminum frame
- Display as a set or individually
- Graphic cover slips over the frame like a pillowcase
- Double-sided graphic cover is viewable from both the front and back of the display
- Tool-free frame assembly allows for quick and easy setup
- Not compatible with EuroFit Connector or other EuroFit accessories



EuroFit Evolution Incline

Item #	Description	1	2-5	6-11	12-24
258200	1.5'W Kit	309.00	300.00	290.00	282.00
258203	3'W Kit	397.00	385.00	373.00	361.00

Kit Includes: Hardware, Graphic Cover and Soft Carry Case USD MSRP (C)

Description	Product Size	Finished Graphic Size	Product Wt.	Media
1.5'W	16"W x 59.25"H x 15.25"D	View Online Template	5.4 lbs.	Recycled Polyester Knit
3'W	35.5"W x 71"H x 15.25"D	View Online Template	8.3 lbs.	Recycled Polyester Knit

EuroFit Evolution One-Shelf Incline

Item #	Description	1	2-5	6-11	12-24
258230	2'W Kit	571.00	559.00	543.00	526.00
258233	3'W Kit	692.00	674.00	657.00	639.00
258236	4'W Kit	820.00	800.00	780.00	765.00

Kit Includes: Hardware, 2 Graphic Covers and Soft Carry Case USD MSRP (C)

Description	Product Size	Finished Graphic Size	Product Wt.	Media
2'W	23.75"W x 59.25"H x 15.25"D	View Online Template	12 lbs.	Recycled Polyester Knit
3'W	35.5"W x 71"H x 15.25"D	View Online Template	16.3 lbs.	Recycled Polyester Knit
4'W	47.25"W x 71"H x 15.25"D	View Online Template	21.2 lbs.	Recycled Polyester Knit

EuroFit Evolution Apparel Incline

Item #	Description	1	2-5	6-11	12-24
258210	2'W Kit	434.00	421.00	408.00	395.00
258213	3'W Kit	526.00	516.00	500.00	485.00

Kit Includes: Hardware, Graphic Cover and Soft Carry Case USD MSRP (C)

Description	Product Size	Finished Graphic Size	Product Wt.	Media
2'W	23"W x 59.25"H x 15.25"D	View Online Template	5.4 lbs.	Recycled Polyester Knit
3'W	35.5"W x 71"H x 15.25"D	View Online Template	7.5 lbs.	Recycled Polyester Knit

EuroFit Evolution Two-Shelf Incline

Item #	Description	1	2-5	6-11	12-24
258240	2'W Kit	825.00	810.00	785.00	765.00
258243	3'W Kit	945.00	925.00	900.00	880.00
258246	4'W Kit	1075.00	1055.00	1020.00	1000.00

Kit Includes: Hardware, 3 Graphic Covers and Soft Carry Case USD MSRP (C)

Description	Product Size	Finished Graphic Size	Product Wt.	Media
2'W	23.75"W x 59.25"H x 15.25"D	View Online Template	16 lbs.	Recycled Polyester Knit
3'W	35.5"W x 71"H x 15.25"D	View Online Template	23 lbs.	Recycled Polyester Knit
4'W	47.25"W x 71"H x 15.25"D	View Online Template	32.2 lbs.	Recycled Polyester Knit



3' One-shelf Incline

1.5' Incline

Shelf attaches magnetically to the hardware and supports up to 20 lbs.

Prices are subject to change; visit our website for the most current pricing.
Setup fee: \$20.00(G).
See pages 208-211 for additional information that may apply to your order.

AFTER FINAL PROOF APPROVAL
PRODUCTION LEAD TIME IS
4 DAYS

JOURNEY SEG

Pack up your SEG and go with this conveniently foldable frame.

- Available in a variety of widths to fill your space
- Artwork is dye sublimated on recycled polyester knit
- 100% recycled media is made with REPREVE® fibers
- Includes two graphic panels for a double-sided display
- 1.625" frame depth
- Journey SEG Connectors (sold separately) link Journey SEG kits to build unique configurations
- Aluminum frame can be recycled after use
- Light your display with the Prime LED Light Kit (sold separately; see page 201)
- Tool-free assembly



Use the 90° Connector Set to build corners with your display.



Bridge Connector Set easily attaches at the top of the frame to allow you to connect a Journey SEG over the top of two Journey SEGs.



Create an intriguing graphic for the underside of the bridge.



Scan to view in 3D



Popular Journey SEG Modular Configurations



T Connector Set used with Journey SEG displays to create separate spaces.



90° Connector Set used with Journey SEG displays can create an enclosed space and connect as half walls.



Create a half wall by turning the Journey SEG on its side.



Bridge Connector Set used with Journey SEG displays to create dimension.

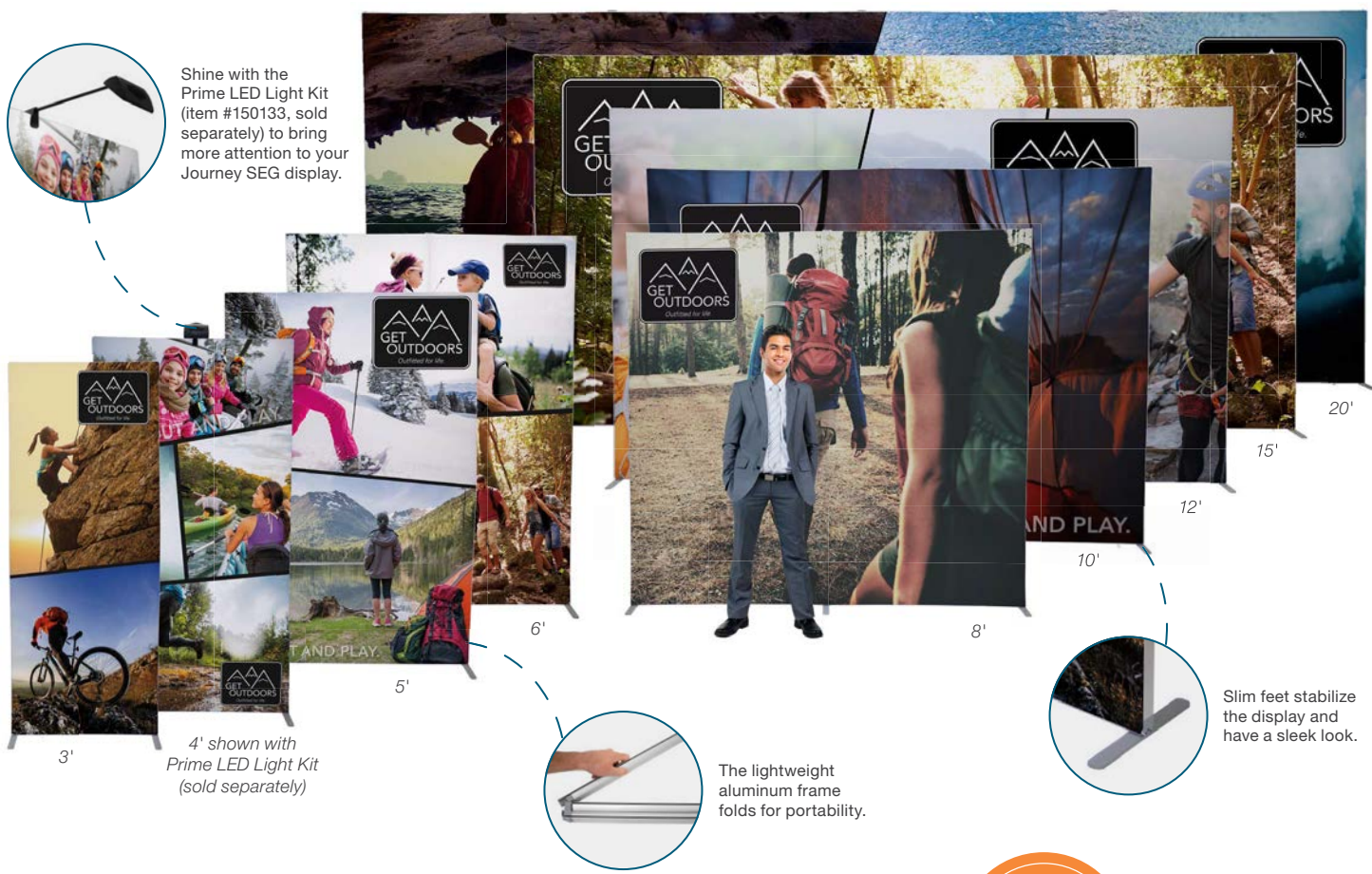

Shine with the Prime LED Light Kit (item #150133, sold separately) to bring more attention to your Journey SEG display.

4' shown with Prime LED Light Kit (sold separately)

The lightweight aluminum frame folds for portability.

Slim feet stabilize the display and have a sleek look.



Journey SEG

Item #	Description	1	2-5	6-11	12-24
254860	3'W Kit	462.00	443.00	425.00	402.00
254863	4'W Kit	571.00	549.00	525.00	496.00
254866	5'W Kit	640.00	614.00	589.00	557.00
254869	6'W Kit	839.00	822.00	767.00	746.00
254872	8'W Kit	947.00	929.00	863.00	840.00
254875	10'W Kit	1485.00	1449.00	1359.00	1313.00
254950	12'W Kit	1816.00	1744.00	1656.00	1587.00
254953	15'W Kit	2408.00	2314.00	2202.00	2103.00
254956	20'W Kit	3036.00	2913.00	2775.00	2650.00

USD MSRP (C)

3'-5'W Kit Includes: Hardware, 2 Graphic Panels and Soft Carry Case
 6'-10'W Kit Includes: Hardware, 2 Graphic Panels, 180° Connector Set and 2 Soft Carry Cases
 12'-15'W Kit Includes: Hardware, 2 Graphic Panels, 2 180° Connector Sets and 3 Soft Carry Cases
 20'W Kit Includes: Hardware, 2 Graphic Panels, 3 180° Connector Sets and 4 Soft Carry Cases

Description	Product Size	Finished Graphic Size	Product Wt.	Media
3'W	36.125"W x 90.625"H x 15.125"D	View Online Template	14 lbs.	Recycled Polyester Knit
4'W	48.125"W x 90.625"H x 15.125"D	View Online Template	15 lbs.	Recycled Polyester Knit
5'W	61"W x 90.625"H x 15.125"D	View Online Template	16.6 lbs.	Recycled Polyester Knit
6'W	72"W x 90.625"H x 15.125"D	View Online Template	26.4 lbs.	Recycled Polyester Knit
8'W	96"W x 90.625"H x 15.125"D	View Online Template	28.4 lbs.	Recycled Polyester Knit
10'W	120"W x 90.625"H x 15.125"D	View Online Template	31.6 lbs.	Recycled Polyester Knit
12'W	144"W x 90.625"H x 15.125"D	View Online Template	48.2 lbs.	Recycled Polyester Knit
15'W	180"W x 90.625"H x 15.125"D	View Online Template	53 lbs.	Recycled Polyester Knit
20'W	240"W x 90.625"H x 15.125"D	View Online Template	71.2 lbs.	Recycled Polyester Knit

Journey SEG Connector Set

Item #	Description	1	2-5	6-11	12-24
254884	180° Connector Set	52.00	50.00	48.00	45.00
254885	90° Connector Set	12.00	12.00	11.00	10.00
254886	Bridge Connector Set	30.00	29.00	28.00	26.00
254887	T Connector Set	10.00	10.00	9.00	9.00

USD MSRP (C)

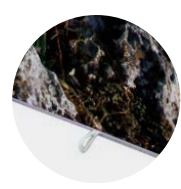

Pull tab lets you quickly remove SEG panel from the frame.

Journey SEG Modular Connector Sets



180° CONNECTOR SET
 Connect two Journey SEGs in a straight line.

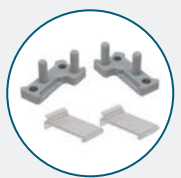

90° CONNECTOR SET
 Connect two Journey SEGs at a 90° angle.



BRIDGE CONNECTOR SET
 Install overhead Journey SEG horizontally across the top of your Journey displays.



T CONNECTOR SET
 Connect three Journey SEGs in a T shape.

HARDWARE-ONLY LEAD TIME: SHIPS SAME DAY WHEN ORDERED BEFORE 2 PM CENTRAL

Prices are subject to change; visit our website for the most current pricing.
 Setup fee: \$20.00(G).
 See pages 208-211 for additional information that may apply to your order.

AFTER FINAL PROOF APPROVAL
 PRODUCTION LEAD TIME IS
4 DAYS



LIGHTS UP!

NEW
BACKLIT
MEDIA



STANDARD SEG GLO

Add a lasting glow to your space with this lit SEG display.

- Easily change out graphic panel to update messaging
- Backlit SEG provides a glow effect
- Artwork is dye sublimated on backlit woven polyester
- Single-sided display
- 2.5" frame depth
- Ladder lights are mounted on a block-out back panel
- Plugs into any standard USA outlet
- Tool-free assembly



Standard SEG Glo

Item #	Description	1	2-5	6-11	12-24
254790	Kit	509.00	488.00	468.00	443.00
Kit Includes: Hardware, Back Panel with Ladder Lights, Graphic Panel and Soft Carry Case				USD MSRP (C)	

Product Size	Finished Graphic Size	Product Wt.	Media
39.375"W x 78.75"H x 13.75"D	View Online Template	14.3 lbs.	Backlit Woven Polyester



LED lights on the back panel of the display create a glow effect.



With a quick press of your thumb, the fabric's gasket edges are pushed into narrow channels built into the frame.



Wall-mounted Standard and Value SEGs are available; see pages 134-135.

AFTER FINAL PROOF APPROVAL
PRODUCTION LEAD TIME IS
4 DAYS

Prices are subject to change; visit our website for the most current pricing.
Setup fee: \$20.00(G).
See pages 208-211 for additional information that may apply to your order.



DELUXE SEG GLO

Double your chances of being noticed with this double-sided lit SEG display.

- Easily change out graphic panels to update messaging
- LED lights built into the sides of the frame illuminate the SEG
- Artwork is dye sublimated on backlit woven polyester
- Includes two graphic panels for a double-sided display
- 3.125" frame depth
- Integrated magnet system allows multiple same-sized units to be linked together; use the included No-Gap Connectors for a tight seam
- Corner Connector can be used to link displays at a 90° angle (sold separately)
- Plugs into any standard USA outlet
- Tool-free assembly

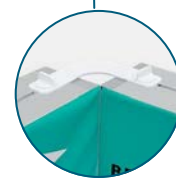

Corner Connector can be used to link to another Deluxe SEG at a 90° angle (sold separately).



Deluxe SEG Glo

Item #	Description	1	2-5	6-11	12-24
254800	3'W x 6.5'H Kit	805.00	772.00	741.00	701.00
254803	3'W x 8'H Kit	1002.00	962.00	922.00	872.00
Kit Includes: Hardware, 2 Graphic Panels, 4 No-Gap Connectors and Soft Carry Case		USD MSRP (C)			

Description	Product Size	Finished Graphic Size	Product Wt.	Media
3'W x 6.5'H	39.375"W x 79.25"H x 15.75"D	View Online Template	20.5 lbs.	Backlit Woven Polyester
3'W x 8'H	39.375"W x 99"H x 15.75"D	View Online Template	23.2 lbs.	Backlit Woven Polyester

Deluxe SEG Glo & Fusion Glo Corner Connector

Item #	Description	1	2-5	6-11	12-24
254850	Corner Connector	12.00	12.00	11.00	10.00
		USD MSRP (C)			



Pull tab lets you quickly remove SEG panel from the frame.



LED lights on the sides of the frame create a glow effect.



Create a tight seam when linking to another Deluxe SEG Glo with included No-Gap Connectors.



HARDWARE-ONLY LEAD TIME: SHIPS SAME DAY WHEN ORDERED BEFORE 2 PM CENTRAL

Prices are subject to change; visit our website for the most current pricing.
Setup fee: \$20.00(G).
See pages 208-211 for additional information that may apply to your order.

AFTER FINAL PROOF APPROVAL
PRODUCTION LEAD TIME IS
4 DAYS



4'W x 4'H can also be used as a tabletop display.

FUSION GLO

This light-up display is incredibly simple to set up so you're ready when it's glow time.

- Artwork is dye sublimated on backlit woven polyester
- Includes two graphic panels for a double-sided display
- SEG for easy graphic panel installation
- 4" frame depth
- Integrated magnet system allows multiple same-sized units to be linked together; use the included No-Gap Connectors for a tight seam
- Corner Connector can be used to link displays at a 90° angle (sold separately; see page 173)
- Plugs into any standard USA outlet
- Tool-free assembly



Fusion Glo

Item #	Description	1	2-5	6-11	12-24
254820	4'W x 4'H Kit	982.00	943.00	904.00	854.00
254823	3'W x 6.5'H Kit	957.00	918.00	881.00	833.00
254826	3'W x 8'H Kit	1203.00	1155.00	1106.00	1047.00

Kit Includes: Hardware, 2 Graphic Panels, 4 No-Gap Connectors and Soft Carry Case USD MSRP (C)

Description	Product Size	Finished Graphic Size	Product Wt.	Media
4' x 4'	51.25"W x 51.75"H x 15.75"D	View Online Template	22.6 lbs.	Backlit Woven Polyester
3' x 6.5'	39.5"W x 79.25"H x 15.75"D	View Online Template	24.2 lbs.	Backlit Woven Polyester
3' x 8'	39.5"W x 99"H x 15.75"D	View Online Template	25.6 lbs.	Backlit Woven Polyester



Lightweight aluminum frame easily pushes together for a tool-free assembly.



LED lights on the top and bottom of the frame create a glow effect.

AFTER FINAL PROOF APPROVAL
PRODUCTION LEAD TIME IS
4DAYS

Prices are subject to change; visit our website for the most current pricing.
Setup fee: \$20.00(G).
See pages 208-211 for additional information that may apply to your order.

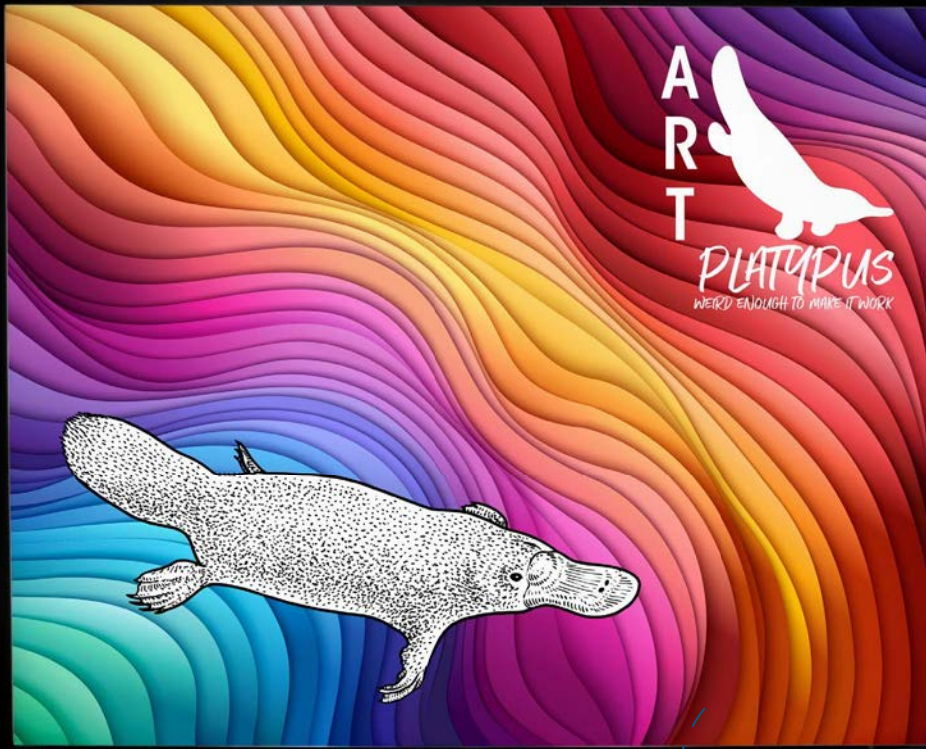

LIGHTS UP!

PREMIER SEG GLO

Illuminate your back wall with this LED lit SEG display!

- Artwork is dye sublimated on backlit woven polyester
- Includes two graphic panels for a double-sided display
- SEG for easy graphic panel installation
- 4.75" frame depth
- Includes foam-lined hard case with wheels
- Plugs into any standard USA outlet
- Tool-free assembly



Included hard case with wheels is foam-lined to protect your SEG during storage and transport. See website for sizing information.

Premier SEG Glo

Item #	Description	1	2-5	6-11	12-24
254840	8'W x 8'H Kit	3016.00	2895.00	2775.00	2624.00
254843	10'W x 8'H Kit	3536.00	3395.00	3253.00	3076.00

Kit Includes: Hardware, 2 Graphic Panels and Hard Case with Wheels USD MSRP (C)

Description	Product Size	Finished Graphic Size	Product Wt.	Media
8' x 8'	94.25"W x 95.25"H x 16.5"D	View Online Template	80.6 lbs.	Backlit Woven Polyester
10' x 8'	118.25"W x 95.25"H x 16.5"D	View Online Template	101.4 lbs.	Backlit Woven Polyester

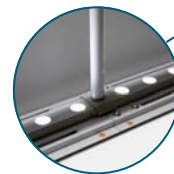

LED lights on the top and bottom of the frame create a glow effect.

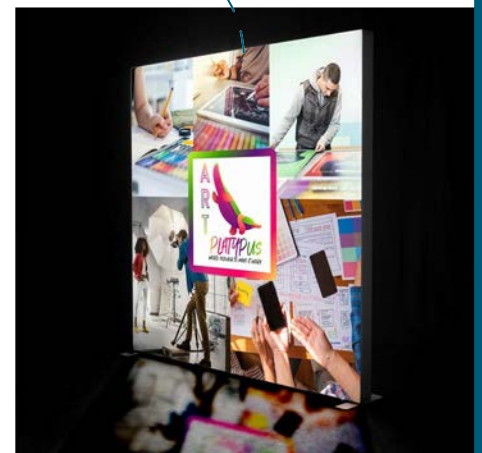

Pull tab lets you quickly remove SEG panel from the frame.



Accessible switch lets you easily turn the lights on and off.

Prices are subject to change; visit our website for the most current pricing.
 Setup fee: \$20.00(G).
 See pages 208-211 for additional information that may apply to your order.

AFTER FINAL PROOF APPROVAL
 PRODUCTION LEAD TIME IS
4 DAYS



LIGHTS UP!



Suggested Uses

- Restaurants
- Retail Stores
- Conventions
- Showrooms

LITFIT WALL

This illuminated display is incredibly simple to set up, so you can light up your message with ease.

- Artwork is dye sublimated on backlit woven polyester
- Lights are optimized for single-sided display
- Plugs into any standard USA outlet
- Not compatible with EuroFit Connector or other EuroFit accessories



LitFit Wall

Item #	Description	1	2-5	6-11	12-24
256503	Kit	1160.00	1135.00	1100.00	1080.00

Kit Includes: Hardware, Graphic Cover and Soft Carry Case USD MSRP (C)

Product Size	Finished Graphic Size	Product Wt.	Media
37.75"W x 91"H x 19"D	View Online Template	20.6 lbs.	Backlit Woven Polyester

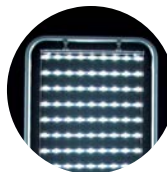

Bright LED lights create a pleasant glow.



The included LED ladder light attaches to the frame using plastic hooks.



Graphic cover slips over the frame like a pillowcase.



1.75" diameter aluminum frame features push-button connectors for easy setup.

PIPE & DRAPE BANNER AND HEADER

These banners and headers can be hung from any standard trade show pipe and drape to make your booth stand out.

- Artwork is dye sublimated on Titan™ no-curl fabric
- S-hooks included
- Pipe and drape not included



120"W x 96"H Banner Kit shown on standard trade show pipe and drape (not included)

Pipe & Drape Banner

Item #	Description	Product Wt.	1	2-5	6-11	12-24
253100	18"W x 48"H Banner Kit	0.36 lb.	72.95	67.10	62.75	58.35
253101	24"W x 60"H Banner Kit	0.5 lb.	90.60	83.35	77.90	72.50
253102	24"W x 72"H Banner Kit	0.6 lb.	109.50	100.70	94.20	87.60
253103	36"W x 96"H Banner Kit	1.2 lbs.	188.80	173.70	162.40	151.00
253115	120"W x 96"H Banner Kit	4 lbs.	571.50	526.00	491.50	457.00

Kit Includes: Graphic and S-Hooks USD MSRP (C)

Pipe & Drape Header

Item #	Description	Product Wt.	1	2-5	6-11	12-24
253105	72"W x 18"H Header Kit	0.45 lb.	109.50	100.70	94.20	87.60
253106	96"W x 12"H Header Kit	0.4 lb.	109.50	100.70	94.20	87.60
253107	96"W x 18"H Header Kit	0.6 lb.	143.40	131.90	123.30	114.70
253108	120"W x 24"H Header Kit	1 lb.	179.90	165.50	154.70	143.90

Kit Includes: Graphic and S-Hooks USD MSRP (C)



Banner is finished with clear plastic grommets that connect to the included S-hooks.



120"W x 24"H Header Kit shown on standard trade show pipe and drape (not included).

AFTER FINAL PROOF APPROVAL
PRODUCTION LEAD TIME IS
4DAYS

Prices are subject to change; visit our website for the most current pricing.
Setup fee: \$20.00(G).
See pages 208-211 for additional information that may apply to your order.

Suggested Uses

Restaurants
Retail Stores
Conventions
Showrooms

NEW
RECYCLED
POLYESTER
KNIT

DELUXE EXHIBITOR EXPANDING DISPLAY

This display features an adjustable frame so it can showcase a variety of banner sizes.

- Vertical and horizontal telescoping poles accommodate various banner sizes (see website for details)
- Artwork is dye sublimated on recycled polyester knit
- 100% recycled media is made with REPREVE® fibers
- 3" pole pockets on the top and bottom of the banner keep it in place
- Screwdriver included
- Custom banner sizes available (call for quote; restrictions may apply)



Deluxe Exhibitor Expanding Display

Item #	Description	1	2-5	6-11	12-24
254140	6' Kit	690.00	670.00	650.00	630.00
254143	6' Banner Only	269.00	261.00	253.00	245.00
254141	7.5' Kit	825.00	800.00	775.00	750.00
254144	7.5' Banner Only	337.00	327.00	317.00	307.00
254142	10' Kit	980.00	950.00	920.00	890.00
254145	10' Banner Only	412.00	400.00	387.00	375.00

Kit Includes: Hardware, Graphic and Soft Carry Case USD MSRP (C)

Description	Product Size	Finished Graphic Size	Product Wt.	Media
6'	69"W x 98"H x 16.5"D	63"W x 95"H	18.25 lbs.	Recycled Polyester Knit
7.5'	84"W x 98"H x 16.5"D	78"W x 95"H	19 lbs.	Recycled Polyester Knit
10'	117"W x 98"H x 16.5"D	111"W x 95"H	20 lbs.	Recycled Polyester Knit



FLOOR DISPLAYS



1.3" diameter pole is strong and durable.

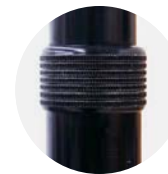

Twist-lock poles let you adjust the height of the display.

BRAVO EXPANDING DISPLAY

The Bravo is the most durable and dependable expanding display available.

- Single- or double-sided banner options available
- Frame poles are adjustable to accommodate a variety of banner sizes (see website for details)
- Reinforced joints keep the banner taut over an extended period of time
- Single-sided graphics are dye sublimated on recycled polyester knit
- 100% recycled media is made with REPREVE® fibers
- Double-sided graphics available on block-out fabric
- Small feet for a discreet footprint
- Custom banner sizes available (call for quote; restrictions may apply)



NEW
RECYCLED
POLYESTER
KNIT

Bravo Expanding Display

Item #	Description	1	2-5	6-11	12-24
254150	8' Single-Sided Kit	780.00	750.00	725.00	695.00
254154	8' Single-Sided Banner Only	378.00	367.00	355.00	344.00
254156	8' Double-Sided Kit	1085.00	1060.00	1030.00	1005.00
254157	8' Double-Sided Banner Only	485.00	475.00	460.00	450.00
254151	10' Single-Sided Kit	945.00	915.00	885.00	860.00
254155	10' Single-Sided Banner Only	458.00	444.00	431.00	417.00
254158	10' Double-Sided Kit	1190.00	1165.00	1130.00	1105.00
254159	10' Double-Sided Banner Only	590.00	580.00	560.00	550.00

Kit Includes: Hardware, Graphic and Soft Carry Case USD MSRP (C)

Description	Product Size	Finished Graphic Size	Product Wt.	Media (Single-Sided/Double-Sided)
8'	94"W x 94.25"H x 14"D	89"W x 93"H	20.2 lbs.	Recycled Polyester Knit / Block-Out Fabric
10'	118"W x 94.25"H x 14"D	113"W x 93"H	22 lbs.	Recycled Polyester Knit / Block-Out Fabric



The vertical clamping system lets you adjust height.









Durable rounded corners.

Prices are subject to change; visit our website for the most current pricing.
Setup fee: \$20.00(G).
See pages 208-211 for additional information that may apply to your order.

AFTER FINAL PROOF APPROVAL
PRODUCTION LEAD TIME IS
4 DAYS

POP-UP DISPLAYS

COMPARISON CHART

BEST SELLERS ★ SUSTAINABLE ◆ PG #	EASE OF SETUP	FRAME WARRANTY	FRAME DETAILS	PANEL INSTALLATION	PANEL MATERIAL	ADD-ON OPTIONS
						SOLD SEPARATELY
NEW! Splash ★ ◆ 180	●●●	2 years	<ul style="list-style-type: none"> high-grade 0.03" aluminum frame scissor construction bayonet locking system medium-weight nylon connecting hubs 	 Hook-and-loop fasteners	Recycled Polyester Knit Block-Out Fabric	Ultimate LED Light Kits
GeoMetrix 182	●●●●	1 year	<ul style="list-style-type: none"> lightweight 0.03" aluminum spring-action pop-up frame 	 Reinforced buttonholes on panels attach to pegs on the frame's hubs	Polyester Double Knit	Ultimate LED Light Kits
Deluxe GeoMetrix ★ 184	●●●	2 years	<ul style="list-style-type: none"> high-grade 0.03" aluminum frame scissor construction bayonet locking system medium-weight nylon connecting hubs rectangular extrusions for stability and shelf strength 	 Reinforced buttonholes on panels attach to pegs on the frame's hubs	Polyester Double Knit	Ultimate LED Light Kits Internal Shelf Stabilizer Feet Connector Shelf Edge Graphic Panels
Deluxe GeoMetrix Connector 186	●●	2 years	<ul style="list-style-type: none"> high-grade 0.03" aluminum frame scissor construction bayonet locking system medium-weight nylon connecting hubs rectangular extrusions for stability and shelf strength 	 Reinforced buttonholes on panels attach to pegs on the frame's hubs	Polyester Double Knit	Ultimate LED Light Kits Internal Shelf Stabilizer Feet Connector Shelf
Echo 189	●●	1 year	<ul style="list-style-type: none"> lightweight 0.03" aluminum spring-action pop-up frame 	 Individual locking channel bars for magnet-to-steel panel registration	Fabric Panels Mural Panels	Ultimate LED Light Kits (included with select kits)
Show 'N Rise 190	●●●	2 years	<ul style="list-style-type: none"> high-grade 0.03" aluminum frame scissor construction bayonet locking system medium-weight nylon connecting hubs rectangular extrusions for stability and shelf strength 	 Shock cord magnet rails for magnet-to-magnet panel registration	Fabric Panels Mural Panels	Internal Shelf
ARISE 191	●●●●	Lifetime	<ul style="list-style-type: none"> high-grade 0.04" extruded aluminum frame self-locking scissor construction medium-weight nylon connecting hubs 	 Magnets connect bars to the frame for magnet-to-magnet panel registration	Fabric Panels Mural Panels	Internal Shelf



PANEL MATERIAL

SPLASH POP-UPS



Wrap graphic panel

BLOCK-OUT FABRIC
Block-out fabric keeps light from shining through your display for perfect photoshoots in well-lit areas.



NEW RECYCLED POLYESTER KNIT

RECYCLED POLYESTER KNIT
Sustainable recycled polyester knit is made with REPREE® fibers recycled from plastic bottles.



Face graphic panel

FLOOR DISPLAYS

GEOMETRIX POP-UPS



Deluxe GeoMetrix
Narrow Corner Connector



GeoMetrix
3-Quad Tower



Deluxe GeoMetrix 9-Quad Classic

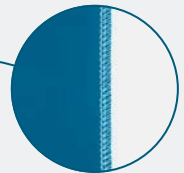

POLYESTER DOUBLE KNIT
Stretches both ways to create a taut fit on GeoMetrix frames, giving you countless options for setting up a creative display.

TRADITIONAL POP-UPS

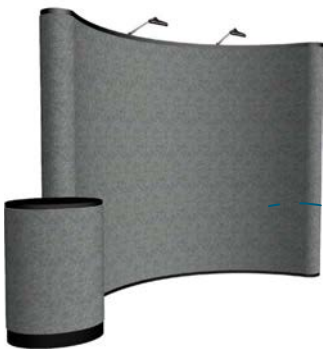

Full fabric panels

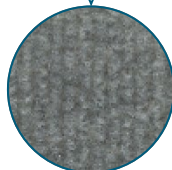

HOOK-AND-LOOP-RECEPTIVE FABRIC
High-quality polyester fiber.



Laminated center mural panels
with fabric end panels

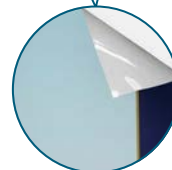

MURAL PANEL
Titan™ no-curl laminated media is rigid so it will not wrinkle or curl.



Laminated full mural panels

SPLASH DISPLAY

This pop-up display transforms from a compact unit to an impressive backdrop in minutes.

- All graphic panels are available in recycled polyester knit; 100% recycled media is made with REPREVE® fibers
- Block-out fabric is available for select displays
- Hook-and-loop fasteners make graphic panel installation simple
- Aluminum frame with nylon plastic hubs
- Tabletop version also available (see page 151)
- US Patent #9214104

Suggested Uses

- Trade Shows
- Presentations
- Media Events
- Conferences



10' tall with face graphic panel

3' straight with wrap graphic panel



10' curved with wrap graphic panel

3' Straight Splash

Item #	Description	Product Wt.	1	2-5	6-11	12-24
341040	3' Recycled Polyester Knit Face Kit	9.4 lbs.	470.00	455.00	435.00	420.00
342200	3' Block-Out Fabric Face Kit	9.5 lbs.	575.00	560.00	540.00	525.00
341041	3' Recycled Polyester Knit Wrap Kit	10.25 lbs.	565.00	550.00	530.00	515.00
342201	3' Block-Out Fabric Wrap Kit	10.25 lbs.	665.00	640.00	615.00	595.00
341042	3' Recycled Polyester Knit 4-Sided Kit	11.5 lbs.	895.00	865.00	840.00	810.00

Kit Includes: Frame, Graphic Panel and Soft Carry Case USD MSRP (C)

Product Size 31"W x 89.5"H x 12.25"D
Finished Graphic Size View Online Template

10' Curved Splash

Item #	Description	Product Wt.	1	2-5	6-11	12-24
341024	10' Recycled Polyester Knit Face Kit	23.6 lbs.	1380.00	1360.00	1335.00	1315.00
342222	10' Block-Out Fabric Face Kit	24.25 lbs.	1480.00	1455.00	1430.00	1410.00
341025	10' Recycled Polyester Knit Wrap Kit	24.5 lbs.	1610.00	1590.00	1565.00	1545.00
342223	10' Block-Out Fabric Wrap Kit	25.75 lbs.	1700.00	1675.00	1655.00	1630.00

Kit Includes: Frame, Graphic Panel and Soft Carry Case USD MSRP (C)

Product Size 117.25"W x 89.5"H x 34"D
Finished Graphic Size View Online Template

10' Tall Straight Splash

Item #	Description	Product Wt.	1	2-5	6-11	12-24
341030	10'H Recycled Polyester Knit Face Kit	30.5 lbs.	1700.00	1640.00	1574.00	1519.00
341031	10'H Recycled Polyester Knit Wrap Kit	31.5 lbs.	1879.00	1810.00	1735.00	1671.00

Kit Includes: Frame, Graphic Panel and Soft Carry Case USD MSRP (C)

Product Size 119"W x 118.25"H x 12.25"D
Finished Graphic Size View Online Template

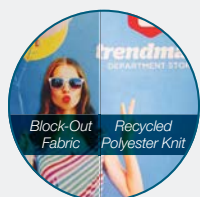

BLOCK-OUT FABRIC
 Block-out fabric is designed to prevent light from showing through the display. It is a good option for brightly lit areas.

RECYCLED POLYESTER KNIT
 Sustainable recycled polyester knit is made with REPREVE® fibers recycled from plastic bottles.

5' Straight Splash

Item #	Description	Product Wt.	1	2-5	6-11	12-24
341046	5' Recycled Polyester Knit Face Kit	10.5 lbs.	820.00	790.00	765.00	735.00
342204	5' Block-Out Fabric Face Kit	16 lbs.	920.00	890.00	855.00	825.00
341047	5' Recycled Polyester Knit Wrap Kit	16.4 lbs.	1005.00	975.00	950.00	920.00
342205	5' Block-Out Fabric Wrap Kit	16.5 lbs.	1105.00	1075.00	1045.00	1015.00
341048	5' Recycled Polyester Knit 4-Sided Kit	18.75 lbs.	1575.00	1520.00	1460.00	1405.00

Kit Includes: Frame, Graphic Panel and Soft Carry Case USD MSRP (C)

Product Size 61"W x 89.5"H x 12.25"D
Finished Graphic Size View Online Template

8' Straight Splash

Item #	Description	Product Wt.	1	2-5	6-11	12-24
341004	8' Recycled Polyester Knit Face Kit	19.25 lbs.	1150.00	1130.00	1105.00	1085.00
342208	8' Block-Out Fabric Face Kit	20 lbs.	1245.00	1220.00	1195.00	1170.00
341005	8' Recycled Polyester Knit Wrap Kit	20 lbs.	1380.00	1360.00	1335.00	1315.00
342209	8' Block-Out Fabric Wrap Kit	20.8 lbs.	1480.00	1455.00	1430.00	1410.00
341052	8' Recycled Polyester Knit 4-Sided Kit	24.25 lbs.	2130.00	2045.00	1960.00	1880.00

Kit Includes: Frame, Graphic Panel and Soft Carry Case USD MSRP (C)

Product Size 90"W x 89.5"H x 12.25"D
Finished Graphic Size View Online Template

8' Curved Splash

Item #	Description	Product Wt.	1	2-5	6-11	12-24
341020	8' Recycled Polyester Knit Face Kit	18.75 lbs.	1150.00	1130.00	1105.00	1085.00
342218	8' Block-Out Fabric Face Kit	19.5 lbs.	1245.00	1220.00	1195.00	1170.00
341021	8' Recycled Polyester Knit Wrap Kit	19.75 lbs.	1380.00	1360.00	1335.00	1315.00
342219	8' Block-Out Fabric Wrap Kit	20.25 lbs.	1480.00	1455.00	1430.00	1410.00

Kit Includes: Frame, Graphic Panel and Soft Carry Case USD MSRP (C)

Product Size 93"W x 89.5"H x 24"D
Finished Graphic Size View Online Template

10' Straight Splash

Item #	Description	Product Wt.	1	2-5	6-11	12-24
341008	10' Recycled Polyester Knit Face Kit	23.75 lbs.	1380.00	1360.00	1335.00	1315.00
342212	10' Block-Out Fabric Face Kit	24.5 lbs.	1480.00	1455.00	1430.00	1410.00
341009	10' Recycled Polyester Knit Wrap Kit	24.75 lbs.	1610.00	1590.00	1565.00	1545.00
342213	10' Block-Out Fabric Wrap Kit	26 lbs.	1700.00	1675.00	1655.00	1630.00
341053	10' Recycled Polyester Knit 4-Sided Kit	31 lbs.	2470.00	2360.00	2245.00	2135.00

Kit Includes: Frame, Graphic Panel and Soft Carry Case USD MSRP (C)

Product Size 119"W x 89.5"H x 12.25"D
Finished Graphic Size View Online Template

20' Straight Splash

Item #	Description	Product Wt.	1	2-5	6-11	12-24
341029	20' Recycled Polyester Knit Wrap Kit	47.75 lbs.	2550.00	2515.00	2480.00	2445.00
342216	20' Block-Out Fabric Wrap Kit	49 lbs.	2620.00	2585.00	2545.00	2510.00

Kit Includes: 2 Frames, Graphic Panel and 2 Soft Carry Cases USD MSRP (C)

Product Size 237"W x 89.5"H x 12.25"D
Finished Graphic Size View Online Template



20' straight with wrap graphic panel



8' curved with face graphic panel

5' straight with wrap graphic panel

Kit Options



Face Graphic Kit
Graphic panel covers the front of the frame.



Wrap Graphic Kit
Graphic panel covers the front and two sides of the frame. Back of the frame is not covered.



4-Sided Graphic Kit
Graphic panel wraps all the way around the frame, covering the front, back and two sides.

Prices are subject to change; visit our website for the most current pricing.
 Setup fee: \$20.00(G).
 See pages 208-211 for additional information that may apply to your order.

AFTER FINAL PROOF APPROVAL
 PRODUCTION LEAD TIME IS
4 DAYS

GEOMETRIX DISPLAY

These displays support a multitude of graphic configurations so you can show off your presentation in a unique way.

- 50% lighter than a standard pop-up display
- Artwork is dye sublimated on polyester double knit
- Tabletop versions also available (see page 152)
- Additional kits and graphic panel kits available online



Centerpoint

GeoMetricx pegs hold up to three panels each.

3-Quad Tower

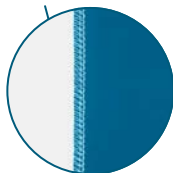

Graphic panels are finished with white stitching.



GeoMetrix Centerpoint Kit

Item #	Description	1	2-5	6-11	12-24
337121	Kit	1710.00	1670.00	1635.00	1595.00
Kit Includes: Twelve-Quad Frame, 10 Graphic Panels and Soft Carry Case		USD MSRP (C)			
Product Size	Finished Graphic Size	Product Wt.	Media		
119.38"W x 90.5"H x 11"D	View Online Template	23 lbs.	Polyester Double Knit		



GeoMetrix Classic Kit

Item #	Description	1	2-5	6-11	12-24
337122	Kit	1405.00	1365.00	1330.00	1290.00
Kit Includes: Nine-Quad Square Frame, 9 Graphic Panels and Soft Carry Case		USD MSRP (C)			
Product Size	Finished Graphic Size	Product Wt.	Media		
90.5"W x 90.5"H x 11"D	View Online Template	18 lbs.	Polyester Double Knit		



GeoMetrix 3-Quad Tower Kit

Item #	Description	1	2-5	6-11	12-24
337126	Kit	540.00	525.00	510.00	495.00
Kit Includes: Three-Quad Tower Frame, 3 Graphic Panels and Soft Carry Case		USD MSRP (C)			
Product Size	Finished Graphic Size	Product Wt.	Media		
31.5"W x 90.5"H x 11"D	View Online Template	7.25 lbs.	Polyester Double Knit		



GeoMetrix Checkerboard Kit

Item #	Description	1	2-5	6-11	12-24
337127	Kit	1405.00	1365.00	1330.00	1290.00
Kit Includes: Nine-Quad Square Frame, 9 Graphic Panels and Soft Carry Case		USD MSRP (C)			
Product Size	Finished Graphic Size	Product Wt.	Media		
90.5"W x 90.5"H x 11"D	View Online Template	18 lbs.	Polyester Double Knit		

Graphic Panels

Graphic panel kits are available online, or you can order graphic panels separately to create your own display; see page 188.



Add-Ons



Ultimate LED Double Light Kit
Item #150121
See Page 201



6' UltraFit Classic Throw
Item #114002
See Page 20

Prices are subject to change; visit our website for the most current pricing.
Setup fee: \$20.00(G).
See pages 208-211 for additional information that may apply to your order.

AFTER FINAL PROOF APPROVAL
PRODUCTION LEAD TIME IS
4 DAYS

DELUXE GEOMETRIX DISPLAY

A strong, durable frame supports multiple graphic panels and shelves so you have countless options for setting up a creative display.

- Setup and teardown can be done in seconds
- Artwork is dye sublimated on polyester double knit
- Aluminum frame with nylon plastic hubs
- Additional kits and graphic panel kits available online
- US Patent #9214104



12-Quad Classic

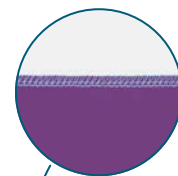

Graphic panels are finished with white stitching.



Shelf has rounded corners and supports up to 15 lbs.



Deluxe GeoMetrix pegs hold up to six panels each.

Add-Ons



Feet slide into frame's hubs to keep the display stable when showcasing merchandise. Feet are not compatible with edge graphic panels.

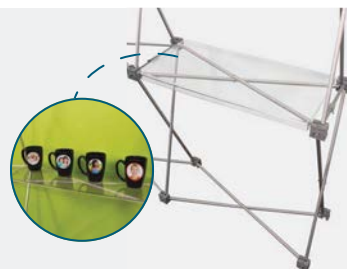

Deluxe GeoMetrix Stabilizer Feet

Item #	Description	1	2-5	6-11	12-24
342070	Set of 4 for Three-Quad Tower Frame	26.90	26.10	25.30	24.50
342072	Set of 8 for Nine-Quad Square Frame	53.90	52.30	50.70	49.00
342073	Set of 10 for Twelve-Quad Frame	67.50	65.50	63.50	61.40

USD MSRP (C)

Deluxe GeoMetrix Internal Shelves

Item #	Description	1	2-5	6-11	12-24
338050	Gray Internal Shelf	139.00	136.00	132.00	128.00
338068	Clear Internal Shelf	149.00	145.00	140.00	136.00

USD MSRP (C)

Each shelf supports up to 15 lbs.

US Patent #D804,228



Deluxe GeoMetrix 9-Quad Header Kit

Item #	Description	1	2-5	6-11	12-24
342004	Kit	1710.00	1670.00	1635.00	1595.00

Kit Includes: Nine-Quad Square Frame, 6 Graphic Panels, USD MSRP (C)
 3 Internal Shelves and Soft Carry Case
 Shelves do not fit in provided soft carry case.
 See page 190 for shelf soft carry case.

Product Size	Finished Graphic Size	Product Wt.	Media
90"W x 89.5"H x 13"D	View Online Template	27 lbs.	Polyester Double Knit



Deluxe GeoMetrix 9-Quad Classic Kit

Item #	Description	1	2-5	6-11	12-24
342006	Kit	1710.00	1670.00	1635.00	1595.00

Kit Includes: Nine-Quad Square Frame, 4 Graphic Panels, USD MSRP (C)
 2 Internal Shelves and Soft Carry Case
 Shelves do not fit in provided soft carry case.
 See page 190 for shelf soft carry case.

Product Size	Finished Graphic Size	Product Wt.	Media
90"W x 89.5"H x 13"D	View Online Template	24 lbs.	Polyester Double Knit



Deluxe GeoMetrix 3-Quad Tower Kit

Item #	Description	1	2-5	6-11	12-24
342010	Kit	780.00	765.00	750.00	735.00

Kit Includes: Three-Quad Tower Frame, 3 Graphic Panels, USD MSRP (C)
 1 Internal Shelf and Soft Carry Case
 Shelves do not fit in provided soft carry case.
 See page 190 for shelf soft carry case.

Product Size	Finished Graphic Size	Product Wt.	Media
31.25"W x 89.5"H x 13"D	View Online Template	11 lbs.	Polyester Double Knit



Deluxe GeoMetrix 12-Quad Presenter Kit

Item #	Description	1	2-5	6-11	12-24
342018	Kit	2020.00	1980.00	1945.00	1905.00

Kit Includes: Twelve-Quad Frame, 5 Graphic Panels, USD MSRP (C)
 2 Internal Shelves and Soft Carry Case
 Shelves do not fit in provided soft carry case.
 See page 190 for shelf soft carry case.

Product Size	Finished Graphic Size	Product Wt.	Media
118"W x 89.5"H x 13"D	View Online Template	29.4 lbs.	Polyester Double Knit



Deluxe GeoMetrix 12-Quad Classic Kit

Item #	Description	1	2-5	6-11	12-24
342000	Kit	2020.00	1980.00	1945.00	1905.00

Kit Includes: Twelve-Quad Frame, 8 Graphic Panels, USD MSRP (C)
 2 Internal Shelves and Soft Carry Case
 Shelves do not fit in provided soft carry case.
 See page 190 for shelf soft carry case.

Product Size	Finished Graphic Size	Product Wt.	Media
118"W x 89.5"H x 13"D	View Online Template	30.5 lbs.	Polyester Double Knit

SHELVES AND STABILIZER FEET SHIP SAME DAY WHEN ORDERED BEFORE 2 PM CENTRAL

Prices are subject to change; visit our website for the most current pricing.
 Setup fee: \$20.00(G).
 See pages 208-211 for additional information that may apply to your order.

AFTER FINAL PROOF APPROVAL
 PRODUCTION LEAD TIME IS
4 DAYS

DELUXE GEOMETRIX CONNECTOR DISPLAY

These brilliant display options feature multiple frames linked together with connector shelves. Edge graphic panels complete the look.

- Impact-resistant clear shelves install in seconds
- Each internal shelf supports up to 15 lbs. and each connector shelf supports up to 5 lbs.
- Artwork is dye sublimated on polyester double knit
- Additional shelves and edge graphic panels can be purchased separately (see pages 187 and 188)
- US Patent #9214104

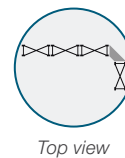

Deluxe GeoMetrix Narrow Corner Connector Kit

Item #	Description	1	2-5	6-11	12-24
342022	Kit	1505.00	1475.00	1430.00	1400.00

Kit Includes: 2 Three-Quad Tower Frames, 4 Graphic Panels, 4 Clear Internal Shelves, 2 Clear Connector Shelves and 2 Soft Carry Cases
Shelves do not fit in provided soft carry cases.
See page 190 for shelf soft carry case.

Product Size	Finished Graphic Size	Product Wt.	Media
51.25"W x 89.5"H x 51.25"D	View Online Template	24.75 lbs.	Polyester Double Knit

Deluxe GeoMetrix L-Corner Connector Kit

Item #	Description	1	2-5	6-11	12-24
342025	Kit	2120.00	2080.00	2015.00	1970.00

Kit Includes: 1 Nine-Quad Square Frame, 1 Three-Quad Tower Frame, 3 Graphic Panels, 1 Nine-Quad Back Wall, 8 Clear Internal Shelves, 2 Clear Connector Shelves and 2 Soft Carry Cases
Shelves do not fit in provided soft carry cases.
See page 190 for shelf soft carry case.

Product Size	Finished Graphic Size	Product Wt.	Media
51.25"W x 89.5"H x 110.25"D	View Online Template	51.35 lbs.	Polyester Double Knit

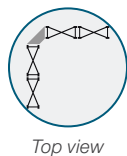

Deluxe GeoMetrix Wide Corner Connector Kit

Item #	Description	1	2-5	6-11	12-24
342028	Kit	2550.00	2500.00	2425.00	2370.00

Kit Includes: 2 Six-Quad Double Stack Frames, 8 Graphic Panels, 4 Clear Internal Shelves, 2 Clear Connector Shelves and 2 Soft Carry Cases
Shelves do not fit in provided soft carry cases.
See page 190 for shelf soft carry case.

Product Size	Finished Graphic Size	Product Wt.	Media
81.25"W x 89.5"H x 81.25"D	View Online Template	42.6 lbs.	Polyester Double Knit

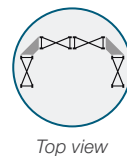

Deluxe GeoMetrix Nook Connector Kit

Item #	Description	1	2-5	6-11	12-24
342031	Kit	2815.00	2760.00	2675.00	2620.00

Kit Includes: 2 Three-Quad Tower Frames, 1 Six-Quad Double Stack Frame, 9 Graphic Panels, 8 Clear Internal Shelves, 4 Clear Connector Shelves and 3 Soft Carry Cases
Shelves do not fit in provided soft carry cases.
See page 190 for shelf soft carry case.

Product Size	Finished Graphic Size	Product Wt.	Media
101.5"W x 89.5"H x 51.25"D	View Online Template	56.7 lbs.	Polyester Double Knit



Deluxe GeoMetrix Ring Connector Kit

Item #	Description	1	2-5	6-11	12-24
342034	Kit	4010.00	3930.00	3810.00	3730.00

Kit Includes: 4 Three-Quad Tower Frames, 36 Graphic Panels, 4 Clear Internal Shelves, 8 Clear Connector Shelves and 4 Soft Carry Cases
Shelves do not fit in provided soft carry cases.
See page 190 for shelf soft carry case.

Product Size	Finished Graphic Size	Product Wt.	Media
71.5"W x 89.5"H x 71.5"D	View Online Template	56.7 lbs.	Polyester Double Knit



Deluxe GeoMetrix Pyramid Corner Connector Kit

Item #	Description	1	2-5	6-11	12-24
342037	Kit	2245.00	2200.00	2135.00	2090.00

Kit Includes: 2 Six-Quad Pyramid Frames, 8 Graphic Panels, 8 Clear Internal Shelves, 2 Clear Connector Shelves and 2 Soft Carry Cases
Shelves do not fit in provided soft carry cases.
See page 190 for shelf soft carry case.

Product Size	Finished Graphic Size	Product Wt.	Media
110.25"W x 89.5"H x 110.25"D	View Online Template	53.2 lbs.	Polyester Double Knit

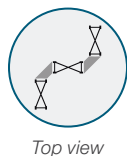

Deluxe GeoMetrix Serpentine Connector Kit

Item #	Description	1	2-5	6-11	12-24
342040	Kit	2745.00	2690.00	2610.00	2555.00

Kit Includes: 3 Three-Quad Tower Frames, 10 Graphic Panels, 4 Clear Internal Shelves, 4 Clear Connector Shelves and 3 Soft Carry Cases
Shelves do not fit in provided soft carry cases.
See page 190 for shelf soft carry case.

Product Size	Finished Graphic Size	Product Wt.	Media
71.5"W x 89.5"H x 71.5"D	View Online Template	43.4 lbs.	Polyester Double Knit

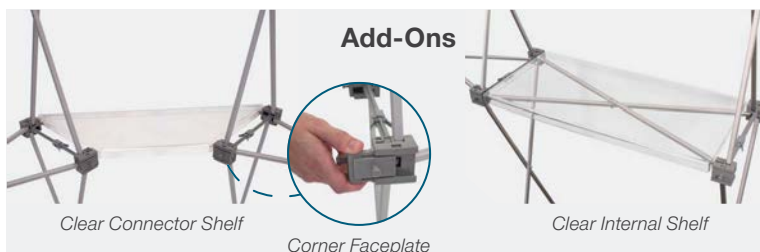

Deluxe GeoMetrix Shelves

US Patent #D804,228

Item #	Description	1	2-5	6-11	12-24
338070	Clear Connector Shelf	149.00	145.00	140.00	136.00
338068	Clear Internal Shelf	149.00	145.00	140.00	136.00
338071	Corner Faceplate	8.00	7.80	7.50	7.30

Connector shelf supports up to 5 lbs.
Internal shelf supports up to 15 lbs.
Connector shelf requires 4 corner faceplates (included with Deluxe GeoMetrix Connector Kits)

SHELVES AND CORNER FACEPLATE SHIP SAME DAY WHEN ORDERED BEFORE 2 PM CENTRAL

Prices are subject to change; visit our website for the most current pricing.
Setup fee: \$20.00(G).
See pages 208-211 for additional information that may apply to your order.

AFTER FINAL PROOF APPROVAL
PRODUCTION LEAD TIME IS
4 DAYS



Graphic panels shown on partial frames for illustrative purposes only. Partial frames not available for purchase.

GEOMETRIX GRAPHIC PANELS

Create a look that is uniquely yours with our wide variety of graphic panels.

- Designed to attach to the frame at specific, predetermined angles (shown to the left)
- Artwork is dye sublimated on polyester double knit
- Hardware sold separately (complete frames only; see website for details)



GeoMetric and Deluxe GeoMetric Graphic Panels

Item #	Description	1	2-5	6-11	12-24
337000	Graphic Panel A	136.00	133.00	131.00	128.00
337001	Graphic Panel B	136.00	133.00	131.00	128.00
337002	Graphic Panel C	136.00	133.00	131.00	128.00
337003	Graphic Panel D	165.00	162.00	158.00	155.00
337004	Graphic Panel E	165.00	162.00	158.00	155.00
337005	Graphic Panel F	241.00	236.00	231.00	227.00
337006	Graphic Panel G	181.00	177.00	174.00	170.00
337007	Graphic Panel H	189.00	185.00	181.00	178.00
337008	Graphic Panel I	189.00	185.00	181.00	178.00
337021	Graphic Panel J	189.00	185.00	181.00	178.00

GeoMetric pegs hold up to 3 panels each. USD MSRP (C)
 Deluxe GeoMetric pegs hold up to 6 panels each.
 View online templates for finished graphic sizes.

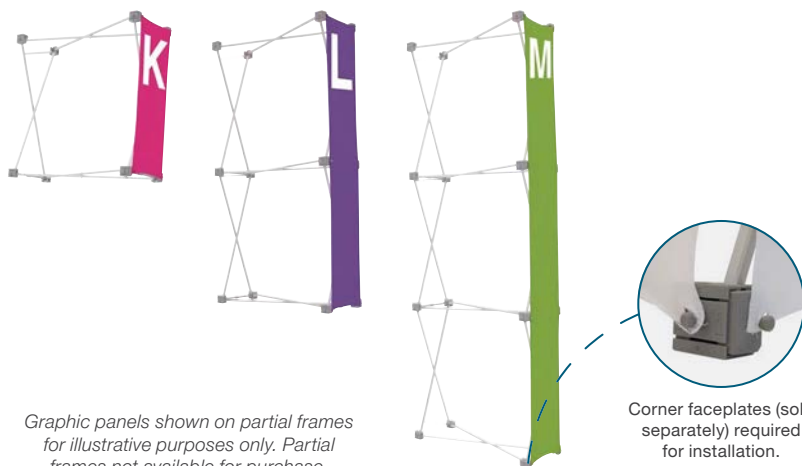

Graphic panels shown on partial frames for illustrative purposes only. Partial frames not available for purchase.

Corner faceplates (sold separately) required for installation.

DELUXE GEOMETRIX EDGE PANELS

These graphic panels run along the edge of the Deluxe GeoMetric display to give you even more options for creative layouts.

- Available in three heights
- Artwork is dye sublimated on polyester double knit
- Designed for the edges of Deluxe GeoMetric frames



Deluxe GeoMetric Edge Graphic Panels

Item #	Description	1	2-5	6-11	12-24
337080	Graphic Panel K	53.90	52.30	50.70	49.00
337081	Graphic Panel L	108.00	105.00	102.00	98.00
337082	Graphic Panel M	161.00	156.00	151.00	147.00
338071	Corner Faceplate	8.00	7.80	7.50	7.30

Deluxe GeoMetric pegs hold up to 6 panels each. USD MSRP (C)
 View online templates for finished graphic sizes.

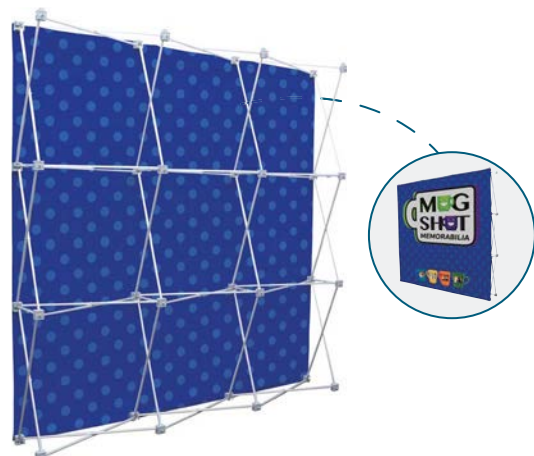

Nine-quad back wall shown on a Deluxe GeoMetric nine-quad square frame (sold separately)

Artwork is visible on both sides so your display stands out from every angle.

DELUXE GEOMETRIX BACK WALL

Block out background distractions by adding a stylish backdrop to your Deluxe GeoMetric display.

- Super poly knit fabric with an opaque polyester block-out liner that features a double-sided silver acrylic coating
- Buttonholes attach to corresponding pegs on Deluxe GeoMetric frames
- Use with nine-quad and twelve-quad Deluxe GeoMetric kits (see page 184)



Deluxe GeoMetric Back Wall

Item #	Description	1	2-5	6-11	12-24
342060	Nine-Quad Double-Sided Back Wall	540.00	530.00	515.00	500.00
342061	Twelve-Quad Double-Sided Back Wall	650.00	635.00	620.00	605.00

Deluxe GeoMetric pegs hold up to 6 panels each. USD MSRP (C)
 View online templates for finished graphic sizes.

AFTER FINAL PROOF APPROVAL
 PRODUCTION LEAD TIME IS
4 DAYS

CORNER FACEPLATE-ONLY LEAD TIME: SHIPS SAME DAY WHEN ORDERED BEFORE 2 PM CENTRAL

Prices are subject to change; visit our website for the most current pricing.
 Setup fee: \$20.00(G).
 See pages 208-211 for additional information that may apply to your order.

Suggested Uses

- Retail
- Museums
- Conferences
- Trade Shows



10' full mural panel kit & lights

ECHO POP-UP DISPLAY

The budget-friendly Echo is a perfect solution for the occasional exhibitor.

- Choose between hook-receptive fabric or mural panels
- Kits available with or without Ultimate LED Double Light Kits
- Case-to-Counter Conversion Kit included



8' Curved Echo

Item #	Description	1	2-5	6-11	12-24
335038	Full Fabric Panel Kit	1444.00	1410.00	1375.00	1341.00
335100	Full Fabric Panel Kit & Lights	1511.00	1477.00	1442.00	1408.00
335040	Center Mural Panels w/ Fabric Ends Kit	1926.00	1892.00	1857.00	1823.00
335102	Center Mural Panels w/ Fabric Ends Kit & Lights	1995.00	1960.00	1925.00	1890.00
335042	Full Mural Panel Kit	2125.00	2090.00	2055.00	2020.00
335104	Full Mural Panel Kit & Lights	2205.00	2170.00	2135.00	2100.00

Kit Includes: See Kit Options

USD MSRP (C)

Product Size	Finished Graphic Size	Product Wt. (No Lights / Lights)	Media
100"W x 91.5"H x 31"D	View Online Template	78 lbs. / 82 lbs.	Titan™ No-Curl Laminated Media

10' Curved Echo

Item #	Description	1	2-5	6-11	12-24
335039	Full Fabric Panel Kit	1648.00	1614.00	1579.00	1545.00
335101	Full Fabric Panel Kit & Lights	1719.00	1685.00	1650.00	1616.00
335041	Center Mural Panels w/ Fabric Ends Kit	2063.00	2029.00	1994.00	1960.00
335103	Center Mural Panels w/ Fabric Ends Kit & Lights	2132.00	2098.00	2063.00	2029.00
335043	Full Mural Panel Kit	2405.00	2371.00	2336.00	2302.00
335105	Full Mural Panel Kit & Lights	2476.00	2442.00	2407.00	2373.00

Kit Includes: See Kit Options

USD MSRP (C)

Product Size	Finished Graphic Size	Product Wt. (No Lights / Lights)	Media
123.5"W x 91.5"H x 34.5"D	View Online Template	88.25 lbs. / 92.5 lbs.	Titan™ No-Curl Laminated Media

Kit Options

Full Fabric Panel Kit Includes:

- Frame & Channel Bars
- Fabric Center Panels
- Fabric End Panels
- Fabric Case-to-Counter Conversion Kit
- Hard Case with Wheels
- Ultimate LED Double Light Kit (select kits)

Center Mural Panels with Fabric Ends Kit Includes:

- Frame & Channel Bars
- Mural Center Panels
- Fabric End Panels
- Graphic Case-to-Counter Conversion Kit
- Hard Case with Wheels
- Ultimate LED Double Light Kit (select kits)

Full Mural Panel Kit Includes:

- Frame & Channel Bars
- Mural Center & End Panels
- Graphic Case-to-Counter Conversion Kit
- Hard Case with Wheels
- Ultimate LED Double Light Kit (select kits)

FABRIC COLORS

Charcoal PMS 424

Lava PMS Black 6

Pacific PMS 280

Steel PMS 429



Lightweight, spring-action frame pops up in seconds.



Locking channel bars hold magnetic panels in place.

FULL FABRIC PANEL KIT LEAD TIME: SHIPS IN 2 DAYS

Prices are subject to change; visit our website for the most current pricing.
 Setup fee: \$20.00(G).
 See pages 208-211 for additional information that may apply to your order.

AFTER FINAL PROOF APPROVAL
 PRODUCTION LEAD TIME IS
3 DAYS

- Meetings
- Press Conferences
- Dealerships
- School Functions



10' curved full mural panel kit

SHOW 'N RISE POP-UP DISPLAY

This best-selling pop-up display is perfect for use at multiple events.

- Choose between hook-receptive fabric or mural panels
- Panels attach to magnet rails for easy alignment
- Case-to-Counter Conversion Kit and Ultimate LED Double Light Kit included
- More kits available online
- US Patent #9214104



FABRIC COLORS

- Charcoal PMS 424
- Lava PMS Black 6
- Pacific PMS 280
- Steel PMS 429

Add-Ons



Shelf soft carry case holds up to four shelves.

Show 'N Rise Internal Shelf

Item #	Description	Product Wt.	1	2-5	6-11	12-24
338050	Internal Straight Shelf	3 lbs.	139.00	136.00	132.00	128.00
220101	Shelf Soft Carry Case	1.25 lbs.	55.40	54.30	52.65	51.50

Internal shelf supports up to 15 lbs. USD MSRP (C)



This kit turns an oval hard case into a podium. It includes an oval wrap, oval hard case and an oval countertop.



Case-to-Counter Kit

Item #	Description	Product Wt.	1	2-5	6-11	12-24
113030	Fabric Kit	4.75 lbs.	687.00	667.00	648.00	634.50
113031	Mural Kit	3.25 lbs.	935.00	904.00	868.00	852.50
113032	UltraFit Kit	2 lbs.	768.00	746.00	724.00	707.50

Kit Includes: Oval Countertop, Oval Wrap and Oval Hard Carry Case
View online templates for finished graphic sizes. Countertop supports up to 20 lbs. USD MSRP (C)

8' Curved Show 'N Rise

Item #	Description	1	2-5	6-11	12-24
339005	Full Fabric Panel Kit	1655.00	1585.00	1515.00	1450.00
339006	Center Mural Panels w/ Fabric Ends Kit	2063.00	1994.00	1925.00	1857.00
339007	Full Mural Panel Kit	2615.00	2565.00	2485.00	2430.00

Kit Includes: See Website USD MSRP (C)

Product Size	Finished Graphic Size	Product Wt.	Media
104"W x 92"H x 31"D	View Online Template	83 lbs.	Titan™ No-Curl Laminated Media

10' Curved Show 'N Rise

Item #	Description	1	2-5	6-11	12-24
339009	Full Fabric Panel Kit	1935.00	1865.00	1795.00	1730.00
339010	Center Mural Panels w/ Fabric Ends Kit	2340.00	2270.00	2200.00	2135.00
339011	Full Mural Panel Kit	2887.00	2818.00	2750.00	2681.00

Kit Includes: See Website USD MSRP (C)

Product Size	Finished Graphic Size	Product Wt.	Media
119"W x 92"H x 36"D	View Online Template	93.75 lbs.	Titan™ No-Curl Laminated Media

10' Straight Show 'N Rise

Item #	Description	1	2-5	6-11	12-24
339013	Full Fabric Panel Kit	2205.00	2140.00	2075.00	2030.00
339014	Center Mural Panels w/ Fabric Ends Kit	2615.00	2545.00	2475.00	2410.00
339015	Full Mural Panel Kit	3155.00	3085.00	3020.00	2950.00

Kit Includes: See Website USD MSRP (C)

Product Size	Finished Graphic Size	Product Wt.	Media
110"W x 92"H x 14"D	View Online Template	82.25 lbs.	Titan™ No-Curl Laminated Media

20' Gullwing Show 'N Rise

Item #	Description	1	2-5	6-11	12-24
339021	Full Fabric Panel Kit	3300.00	3230.00	3160.00	3095.00
339022	Center Mural Panels w/ Fabric Ends Kit	4260.00	4125.00	3985.00	3850.00
339023	Full Mural Panel Kit	4811.00	4674.00	4536.00	4399.00

Kit Includes: See Website USD MSRP (C)

Product Size	Finished Graphic Size	Product Wt.	Media
238"W x 92"H x 36"D	View Online Template	177.5 lbs.	Titan™ No-Curl Laminated Media

FULL FABRIC PANEL KIT LEAD TIME: SHIPS IN 2 DAYS

Prices are subject to change; visit our website for the most current pricing.
Setup fee: \$20.00(G).
See pages 208-211 for additional information that may apply to your order.

SHOW 'N RISE
AFTER FINAL PROOF APPROVAL
PRODUCTION LEAD TIME IS
3 DAYS OF SHIPS
HARDWARE-ONLY
SAMEDAY
WHEN ORDERED BEFORE 2 PM CENTRAL

Suggested Uses

- Trade Shows
- In-Store Giveaways
- Product Demos
- Presentations

ARISE POP-UP DISPLAY

This pop-up display is specifically engineered for the trade show professional.

- Choose between hook-receptive fabric or mural panels
- Panels attach to magnet bars for easy alignment
- Case-to-Counter Conversion Kit and Ultimate LED Double Light Kit included
- More kits available online



10' curved full mural panel kit

FABRIC COLORS



8' Curved ARISE

Item #	Description	1	2-5	6-11	12-24
332222	Full Fabric Panel Kit	1935.00	1865.00	1795.00	1730.00
332246	Center Mural Panels w/ Fabric Ends Kit	2340.00	2270.00	2200.00	2135.00
332254	Full Mural Panel Kit	2887.00	2818.00	2750.00	2681.00

Kit Includes: See Website USD MSRP (C)

Product Size	Finished Graphic Size	Product Wt.	Media
100"W x 89.5"H x 26.25"D	View Online Template	83.25 lbs.	Titan™ No-Curl Laminated Media

10' Curved ARISE

Item #	Description	1	2-5	6-11	12-24
332223	Full Fabric Panel Kit	2205.00	2135.00	2065.00	2000.00
332247	Center Mural Panels w/ Fabric Ends Kit	2615.00	2545.00	2475.00	2410.00
332255	Full Mural Panel Kit	3155.00	3085.00	3020.00	2950.00

Kit Includes: See Website USD MSRP (C)

Product Size	Finished Graphic Size	Product Wt.	Media
120.75"W x 89.5"H x 38.5"D	View Online Template	94 lbs.	Titan™ No-Curl Laminated Media

10' Straight ARISE

Item #	Description	1	2-5	6-11	12-24
332224	Full Fabric Panel Kit	2205.00	2135.00	2065.00	2000.00
332248	Center Mural Panels w/ Fabric Ends Kit	2615.00	2545.00	2475.00	2410.00
332256	Full Mural Panel Kit	3155.00	3085.00	3020.00	2950.00

Kit Includes: See Website USD MSRP (C)

Product Size	Finished Graphic Size	Product Wt.	Media
109.5"W x 89.5"H x 12.5"D	View Online Template	86 lbs.	Titan™ No-Curl Laminated Media

20' Gullwing ARISE

Item #	Description	1	2-5	6-11	12-24
332226	Full Fabric Panel Kit	3574.00	3505.00	3437.00	3368.00
332250	Center Mural Panels w/ Fabric Ends Kit	4530.00	4395.00	4255.00	4120.00
332258	Full Mural Panel Kit	5155.00	5020.00	4880.00	4745.00

Kit Includes: View Website USD MSRP (C)

Product Size	Finished Graphic Size	Product Wt.	Media
240"W x 89.5"H x 38.5"D	View Online Template	178 lbs.	Titan™ No-Curl Laminated Media

FULL FABRIC PANEL KIT LEAD TIME: SHIPS IN 2 DAYS

Prices are subject to change; visit our website for the most current pricing.
Setup fee: \$20.00(G).
See pages 208-211 for additional information that may apply to your order.

Add-Ons

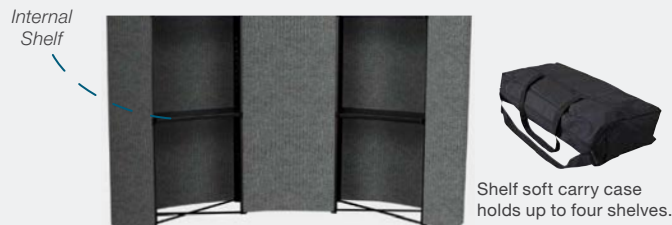

ARISE Shelf

Item #	Description	Product Wt.	1	2-5	6-11	12-24
290036	Internal Curve Shelf	3 lbs.	151.00	148.00	146.00	143.00
220101	Shelf Soft Carry Case	1.25 lbs.	55.40	54.30	52.65	51.50

Internal shelf supports up to 15 lbs. USD MSRP (C)



Case-to-Counter Kit

Item #	Description	Product Wt.	1	2-5	6-11	12-24
113030	Fabric Kit	4.75 lbs.	687.00	667.00	648.00	634.50
113031	Mural Kit	3.25 lbs.	935.00	904.00	868.00	852.50
113032	UltraFit Kit	2 lbs.	768.00	746.00	724.00	707.50

Kit Includes: Oval Countertop, Oval Wrap and Oval Hard Carry Case
View online templates for finished graphic sizes. Countertop supports up to 20 lbs. USD MSRP (C)

ARISE AFTER FINAL PROOF APPROVAL PRODUCTION LEAD TIME IS **3 DAYS** OF **SHIPS SAMEDAY** WHEN ORDERED BEFORE 2 PM CENTRAL

STANDS & FURNITURE

When choosing a stand or furniture
have you considered...

- **SIZE** - What is the size of your space?
- **FREQUENCY** - How often will you be setting up and taking down your stand or furniture?
- **TRANSPORT** - How will this item be transported?
- **LIGHTING** - Will this be set up in a brightly lit space, or does it need its own lighting?
- **POWER** - Will power be available?



Suggested Uses

Conventions
Grocery Stores
School Events
Product Demos

NEW
RECYCLED
POLYESTER
KNIT

NEW
SIZES



COUNTERPOP

Combining the features of a counter and a pop-up display, the CounterPop is truly a multifunctional display.

- Available in three widths
- Artwork is dye sublimated on recycled polyester knit
- 100% recycled media is made with REPREEVE® fibers
- Countertop supports up to 30 lbs.; internal shelves support up to 10 lbs.

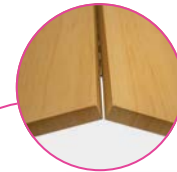

Countertop folds in half for convenient storage.



MDF countertop and internal shelf with woodgrain laminate.

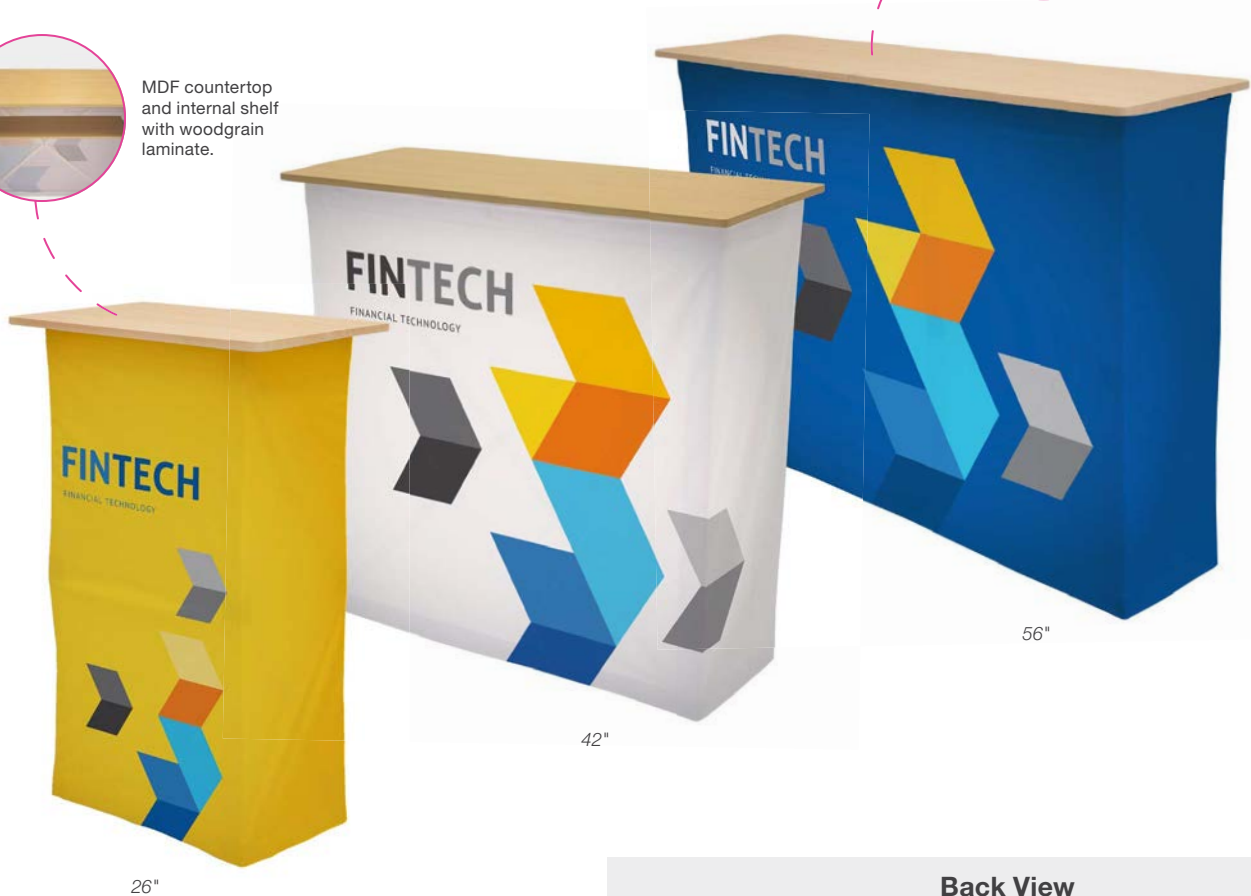

CounterPop

Item #	Description	1	2-5	6-11	12-24
256800	26" Kit	550.00	533.50	517.00	500.50
257055	42" Kit	634.50	615.50	596.50	577.50
256803	56" Kit	710.00	689.00	667.50	646.00

Kit Includes: Hardware, Graphic Panel and Soft Carry Case USD MSRP (C)

Description	Product Size	Finished Graphic Size	Product Wt.	Media
26"	26"W x 40"H x 15.75"D	View Online Template	17 lbs.	Recycled Polyester Knit
42"	41.75"W x 40"H x 15.75"D	View Online Template	22.25 lbs.	Recycled Polyester Knit
56"	55.875"W x 40"H x 15.75"D	View Online Template	28 lbs.	Recycled Polyester Knit

Back View



Prices are subject to change; visit our website for the most current pricing.
Setup fee: \$20.00(G).
See pages 208-211 for additional information that may apply to your order.

AFTER FINAL PROOF APPROVAL
PRODUCTION LEAD TIME IS
4 DAYS



Rectangle

Oval



Threaded poles twist together for easy setup.



With a quick press of your thumb, the fabric's gasket edges are pushed into a narrow channel built into the countertop and base.



Zippered back creates an enclosed storage area.

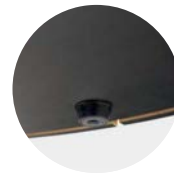

Rubber feet for stability.

IMPRESS COUNTERS

These easy-to-assemble counters feature your full-color artwork on the outside and storage space on the inside.

- SEG for easy graphic panel installation
- Artwork is dye sublimated on two-way stretch fabric
- Black MDF countertop
- Countertop supports up to 20 lbs.



Impress Oval Counter

Item #	Description	1	2-5	6-11	12-24
257044	Kit	506.00	490.50	475.50	460.50
Kit Includes: Hardware, Graphic Panel and Soft Carry Case				USD MSRP (C)	

Product Size	Finished Graphic Size	Product Wt.	Media
23.375"W x 39.75"H x 15.5"D	View Online Template	16 lbs.	Two-Way Stretch Fabric

Impress Rectangle Counter

Item #	Description	1	2-5	6-11	12-24
257047	Kit	572.50	555.50	538.00	521.00
Kit Includes: Hardware, Graphic Panel and Soft Carry Case				USD MSRP (C)	

Product Size	Finished Graphic Size	Product Wt.	Media
31.5"W x 39.75"H x 20.875"D	View Online Template	23.5 lbs.	Two-Way Stretch Fabric

Suggested Uses

- Hospitality
- Trade Shows
- Department Stores
- Schools



SHOWGOER CASE-TO-PODIUM

Take your display on the go. This podium converts into a wheeled case for simple, worry-free transportation.

- Dye-sublimated wrap slides on for easy setup
- Durable, roto-molded case
- Removable top and built-in tray for quick access to your show materials
- Countertop supports up to 20 lbs.



ShowGoer Case-to-Podium

Item #	Description	1	2-5	6-11	12-24
257030	Kit	686.00	665.50	645.00	624.50
257031	Hard Case with Wheels Only	415.25	402.75	390.25	378.00
Kit Includes: Hard Case with Wheels and Graphic Wrap				USD MSRP (C)	

Product Size	Finished Graphic Size	Product Wt.	Media
38.375"W x 34.875"H x 16.875"D	View Online Template	27.5 lbs.	Two-Way Stretch Fabric

Stunning on the show floor, convenient in storage.



Wheels and pull-up handle make transport easy.



HARDWARE-ONLY LEAD TIME: SHIPS SAME DAY WHEN ORDERED BEFORE 2 PM CENTRAL

Prices are subject to change; visit our website for the most current pricing.
Setup fee: \$20.00(G).

See pages 208-211 for additional information that may apply to your order.

AFTER FINAL PROOF APPROVAL
PRODUCTION LEAD TIME IS
4 DAYS

POWER PEDESTAL

Let your guests charge their mobile devices at this handy pedestal, covered in a full-color design that shows off your logo or marketing message.

- Chargers for Lightning, Micro USB and USB Type-C are included
- SEG for easy graphic panel installation
- Graphic panel is dye sublimated on two-way stretch fabric
- Surface grip decal is removable and repositionable
- Aluminium tubing structure with a composite wood surface
- Plugs into any standard USA outlet
- Tabletop supports up to 20 lbs.
- A power strip (not included) is recommended for use with this product



Power Pedestal

Item #	Description	1	2-5	6-11	12-24
257080	Kit	1240.00	1202.00	1166.00	1128.00
257083	Kit with Tabletop Decal	1257.00	1219.00	1182.00	1144.00

Kit Includes: Hardware, Graphic Panel and Soft Carry Case USD MSRP (C)

Product Size	Finished Graphic Size	Product Wt. (Kit / Kit w/Decal)	Media (Panel / Decal)
27.5"W x 36.875"H x 27.5"D	View Online Template	19 lbs. / 19.5 lbs.	Two-Way Stretch Fabric / Surface Grip



Cover the tabletop with a full-color decal (included in kit #257083 or sold separately).



Charging cables are guided through holes in the pedestal's tabletop.

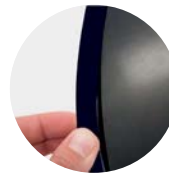

With a quick press of your thumb, the fabric's gasket edges are pushed into a narrow channel built into the tabletop and base.



Joints are labeled for step-by-step assembly.

SHOWGLOWER PODIUM

Shine some light on your message or brand with this backlit podium.

- The MDF tabletop offers a great deal of usable surface
- SEG for easy graphic panel installation
- Artwork is dye sublimated on backlit woven polyester
- Plugs into any standard USA outlet
- Countertop supports up to 30 lbs.



LIGHTS UP!

ShowGlower Podium

Item #	Description	1	2-5	6-11	12-24
257064	Kit	881.00	854.00	828.00	801.50

Kit Includes: Hardware, Graphic Panel and Soft Carry Case USD MSRP (C)

Product Size	Finished Graphic Size	Product Wt.	Media
31.5"W x 39.75"H x 20.875"D	View Online Template	29.5 lbs.	Backlit Woven Polyester

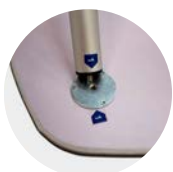

Joints are labeled for step-by-step assembly.



With a quick press of your thumb, the fabric's gasket edges are pushed into a narrow channel built into the countertop and base.



LED lights are embedded in the display base to create a glow effect.

Prices are subject to change; visit our website for the most current pricing.
Setup fee: \$20.00(G).
See pages 208-211 for additional information that may apply to your order.

AFTER FINAL PROOF APPROVAL
PRODUCTION LEAD TIME IS
4 DAYS



POWER UP!

NEW BACKLIT MEDIA

LIGHTS UP!

SHOWGLOWER POWER TABLE

Keep your guests in your booth even longer while they charge their electronics at this illuminated power table.

- Chargers for Lightning, Micro USB and USB Type-C are included
- Display also features a Qi certified wireless induction charger
- SEG for easy graphic panel installation
- A single graphic panel wraps all the way around the display
- Artwork is dye sublimated on backlit woven polyester
- MDF wood tabletop supports up to 25 lbs.
- Plugs into any standard USA outlet
- A power strip (not included) is recommended for use with this product



ShowGlower Power Table

Item #	Description	1	2-5	6-11	12-24
257067	Kit	1076.00	1044.00	1011.00	979.00
Kit Includes: Hardware, Graphic Panel and 2 Soft Carry Cases		USD MSRP (C)			

Product Size	Finished Graphic Size	Product Wt.	Media
23.625"W x 21.375"H x 23.625"D	View Online Template	56.6 lbs.	Backlit Woven Polyester



LED lights on the top and bottom of the display create a glow effect.



With a quick press of your thumb, the fabric's gasket edges are pushed into narrow channels built into the frame.

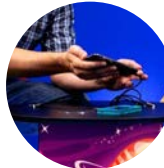

Charging cables are guided through holes in the tabletop.



POWER UP!

NEW BACKLIT MEDIA

LIGHTS UP!

SHOWGLOWER POWER STATION

Light up your logo or artwork on this illuminated charging station.

- Chargers for Lightning, Micro USB and USB Type-C are included
- Display also features a Qi certified wireless induction charger
- Artwork is dye sublimated on backlit woven polyester
- SEG for easy graphic panel installation
- A single graphic panel wraps all the way around the display
- Tabletop supports up to 30 lbs.
- Plugs into any standard USA outlet
- A power strip (not included) is recommended for use with this product



ShowGlower Power Station

Item #	Description	1	2-5	6-11	12-24
257085	Kit	3102.00	3009.00	2916.00	2823.00
Kit Includes: Hardware, Graphic Panel and 2 Soft Carry Cases		USD MSRP (C)			

Product Size	Finished Graphic Size	Product Wt.	Media
19.75"W x 39.375"H x 19.75"D	View Online Template	43.25 lbs.	Backlit Woven Polyester

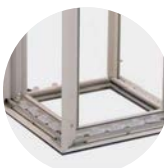

LED lights on the top and bottom of the display create a glow effect.



With a quick press of your thumb, the fabric's gasket edges are pushed into narrow channels built into the frame.



Charging cables are guided through holes in the pedestal's tabletop.



Rubber feet elevate the display to make room for the power cord.

AFTER FINAL PROOF APPROVAL
PRODUCTION LEAD TIME IS
4 DAYS

Prices are subject to change; visit our website for the most current pricing.
Setup fee: \$20.00(G).
See pages 208-211 for additional information that may apply to your order.

SHOWGLOWER COUNTER

Light up your brand with this glowing counter unit.

- Available in two display options: graphic panels on both the front and back, or graphic panel on the front with a block-out panel on the back
- Artwork is dye sublimated on backlit woven polyester
- SEG for easy graphic panel installation
- Lightweight aluminum frame
- With a quick press of your thumb, the fabric's gasket edges are pushed into narrow channels built into the front and back of the frame
- LED lights are embedded in the display frame for a soft glow
- Countertop supports up to 20 lbs.
- Plugs into any standard USA outlet



ShowGlower Counter

Item #	Description	1	2-5	6-11	12-24
257140	Kit	800.00	776.00	752.00	728.00
Kit Includes: Hardware, 2 Graphic Panels, 4 No-Gap Connectors and Soft Carry Case		USD MSRP (C)			

ShowGlower Counter with Block-Out Back Panel

Item #	Description	1	2-5	6-11	12-24
257141	Kit	910.00	882.50	855.50	828.00
Kit Includes: Hardware, Graphic Panel, Block-Out Back Panel, 4 No-Gap Connectors and Soft Carry Case		USD MSRP (C)			

Description	Product Size	Finished Graphic Size	Product Wt.	Media
Kit	39.375"W x 40.5"H x 15.75"D	View Online Template	25.4 lbs.	Backlit Woven Polyester
Block-Out Kit	39.375"W x 40.5"H x 15.75"D	View Online Template	25.4 lbs.	Backlit Woven Polyester / Block-Out Fabric

SHOWGLOWER TOTEM & TOTEM TABLE

This bright tower offers an eye-catching appearance with a small footprint.

- Easy setup: Pull it up and clip it together in seconds
- Artwork is dye sublimated on backlit woven polyester
- LED lights in the display create a soft glow
- Tabletop supports up to 10 lbs.
- Plugs into any standard USA outlet
- Soft carry case not included



ShowGlower Totem

Item #	Description	1	2-5	6-11	12-24
254905	44" Kit	980.00	951.00	921.00	892.00
254913	84" Kit	1490.00	1446.00	1400.00	1356.00
Kit Includes: Hardware and Graphic Panel		USD MSRP (C)			

Description	Product Size	Finished Graphic Size	Product Wt.	Media
44"	15.625"W x 43.25"H x 15.625"D	View Online Template	13.8 lbs.	Backlit Woven Polyester
84"	15.625"W x 82.5"H x 15.625"D	View Online Template	21.8 lbs.	Backlit Woven Polyester

ShowGlower Totem Table

Item #	Description	1	2-5	6-11	12-24
254908	44" Table Kit	1190.00	1155.00	1118.00	1083.00
Kit Includes: Hardware, Tabletop and Graphic Panel		USD MSRP (C)			

Product Size	Finished Graphic Size	Product Wt.	Media
22.625"W x 43.25"H x 22.625"D	View Online Template	19 lbs.	Backlit Woven Polyester

Prices are subject to change; visit our website for the most current pricing.

Setup fee: \$20.00(G).

See pages 208-211 for additional information that may apply to your order.

NEW
PRODUCT

NEW
BACKLIT
MEDIA

LIGHTS UP!



STANDS & FURNITURE

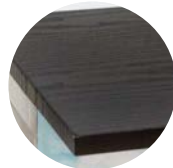

The MDF tabletop offers a great deal of usable surface.



Integrated magnet system allows multiple units to be linked together.

NEW
PRODUCT

NEW
BACKLIT
MEDIA

LIGHTS UP!



Collapses flat as a single piece for simple, fast teardown.



44" Totem can be displayed with or without the tabletop attachment.

AFTER FINAL PROOF APPROVAL
PRODUCTION LEAD TIME IS
4 DAYS



POWER UP!

NEW BACKLIT MEDIA

LIGHTS UP!

SHOWGLOWER POWER TOWER

The lamppost design of this charging station makes it hard to miss, and it lights up to complete the look.

- Chargers for Lightning, Micro USB and USB Type-C are included
- Display also features a Qi certified wireless induction charger
- Artwork is dye sublimated on backlit woven polyester
- SEG for easy graphic panel installation
- Each graphic panel wraps all the way around the display
- Tabletop supports up to 30 lbs.
- Plugs into any standard USA outlet
- Assembly tools included
- A power strip (not included) is recommended for use with this product



ShowGlower Power Tower

Item #	Description	1	2-5	6-11	12-24
257088	Kit	2820.00	2735.00	2651.00	2566.00
Kit Includes: Hardware, 2 Graphic Panels and 3 Soft Carry Cases					USD MSRP (C)
Product Size	Finished Graphic Size	Product Wt.	Media		
19.75"W x 90.75"H x 19.75"D	View Online Template	87.25 lbs.	Backlit Woven Polyester		



Rubber feet elevate the display to make room for the power cord.



Charging cables are guided through holes in the pedestal's tabletop.



With a quick press of your thumb, the fabric's gasket edges are pushed into a narrow channel built into the frame.



LED lights on the top and bottom of the display create a glow effect.

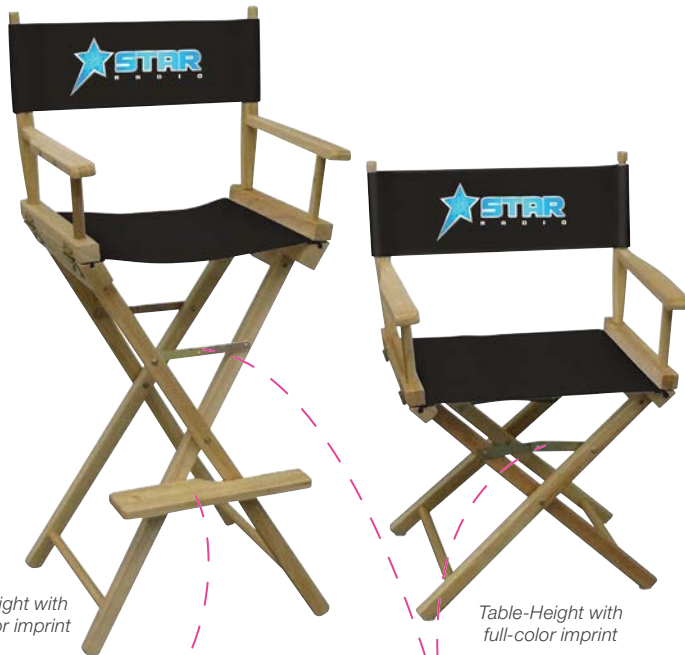

Bar-Height with full-color imprint

Table-Height with full-color imprint



The Bar-Height chair features a footrest that naturally folds out as you open it.



Hinges lock to keep the chair stable.

DIRECTOR'S CHAIR

This classic chair design is casual, functional and versatile.

- Made in the USA from Appalachian Beech hardwood
- Natural woodgrain will have some color and pattern variation
- Heavy-duty canvas seat and seat backing
- Supports up to 225 lbs.
- Our floor display hard case with wheels (Item #220023) will hold two director's chairs (sold separately; see page 200)



Unimprinted

Item #	Description	1	2-5	6-11	12-24
111025	Table-Height	198.90	192.90	187.00	181.00
111029	Bar-Height	230.30	223.40	216.50	209.60
Stock fabric colors.					USD MSRP (C)

Full-Color Imprint

Item #	Description	1	2-5	6-11	12-24
111026	Table-Height	213.90	207.50	201.10	194.60
111030	Bar-Height	260.50	252.75	244.75	237.00
Stock fabric colors imprinted with any color(s).					USD MSRP (C)

Description	Product Size	Finished Graphic Size	Product Wt.
Table-Height	23"W x 34.25"H x 18"D (Seat Height 18")	13"W x 4.5"H	11 lbs.
Bar-Height	24.125"W x 46.5"H x 21"D (Seat Height 30.25")	13"W x 4.5"H	14 lbs.

STOCK CANVAS COLORS

- Black
- Burgundy PMS 7421
- Hunter Green PMS 3302
- Khaki PMS 7502
- Navy Blue PMS 2767
- Orange PMS 1655
- Red PMS 186
- Royal Blue PMS 2738
- White

PMS colors are for reference only and may vary slightly from actual color.

SHOWGLOWER CHAIR
AFTER FINAL PROOF APPROVAL
PRODUCTION LEAD TIME IS
4 OF 3 DAYS

HARDWARE-ONLY LEAD TIME: SHIPS SAME DAY WHEN ORDERED BEFORE 2 PM CENTRAL

Prices are subject to change; visit our website for the most current pricing.
Setup fee: \$20.00(G).
See pages 208-211 for additional information that may apply to your order.

EASELS

Display announcements, artwork, sign frames and more with these versatile and durable easels.

- Extendable legs allow for use as a tabletop display or standalone floor display
- Tripod structure for easy placement in corners
- Each easel holds up to 20 lbs.

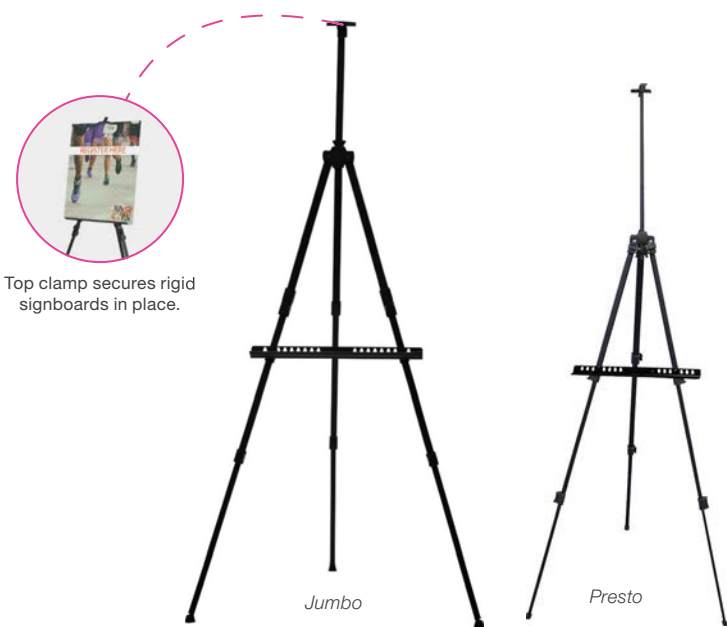

Top clamp secures rigid signboards in place.

Jumbo

Presto

Easels

Item #	Description	1	2-5	6-11	12-24
400011	Presto Easel	75.50	72.50	69.45	67.20
400052	Jumbo Easel	120.80	116.00	111.10	107.50

USD MSRP (C)

Description	Product Size	Product Wt.
Presto Easel	38"W x 20"-63.625"H x 32"D	2 lbs.
Jumbo Easel	20"W x 24"-72"H x 16"D	4.5 lbs.

LITERATURE DISPLAYS

Keep your brochures and catalogs prominently displayed with these compact literature displays.



Literature Displays

Item #	Description	Pocket	1	2-5	6-11	12-24
230025	Easy View Display	1.375"D	371.25	360.00	349.00	337.75
230003	Clear View Display	1.34"D	215.10	208.60	202.20	195.70
261244	Display Mate		107.00	103.80	100.60	97.40

USD MSRP (C)

Literature Display Decal

Item #	Description	Finished Graphic Size	1	2-5	6-11	12-24
230027	Easy View Decal	8.5"W x 13.5"H	17.49	16.97	16.44	15.92

Graphic Decal will NOT come applied when purchased with the display. USD MSRP (C)

Description	Product Size	Product Wt.	Media
Easy View	10.75"W x 61.5"H x 14.625"D	11.75 lbs.	Surface Grip
Clear View	10"W x 60.75"H x 11"D	11.5 lbs.	NA
Display Mate	13"W x 39.5"H x 15.125"D	6.4 lbs.	NA

Clear View Display

- Four-tier design with acrylic trays
- Sturdy chrome base
- Stores literature when not in use
- Collapses to fit into included soft carry case
- Pocket size: 9.25"W x 14"H x 1.34"D



Collapsed

Easy View Display

- Decal (sold separately) lets you personalize the front of the stand
- Five-tier design with plastic trays
- Collapses to fit into included soft carry case
- Stores literature when not in use
- Available in black or white
- Pocket size: 8.5"W x 12.375"H x 1.375"D

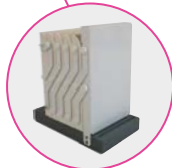

Collapsed

White display shown with decal (sold separately)

DISPLAY COLORS ● Black ○ White



Retractable banner sold separately

Display Mate

- Designed for use with select retractor and banner stands
- Lightweight and portable
- U-shaped steel base slides easily under display bases
- Easy to assemble
- Holds up to 3 pounds or 300 sheets of paper
- Assembly tool included

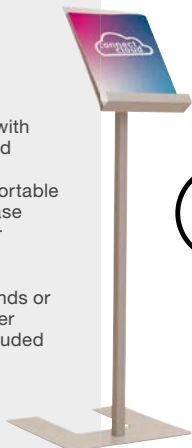

HARDWARE-ONLY LEAD TIME: SHIPS SAME DAY WHEN ORDERED BEFORE 2 PM CENTRAL

Prices are subject to change; visit our website for the most current pricing.
Setup fee: \$20.00(G).
See pages 208-211 for additional information that may apply to your order.

AFTER FINAL PROOF APPROVAL
PRODUCTION LEAD TIME IS
2 DAYS

HARD CASES

Add extra protection to your investment with a wide selection of hard case options.

- Hard cases feature easy-grip handles or straps
- Cases have a one-year warranty

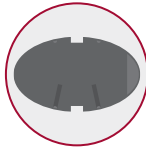

Inside view

Item #220017
Oval Hard Case with Wheels
 - Best for floor displays like the ARISE, Show 'N Rise and Echo (Case-to-counter conversion kit sold separately; see website).



Inside view

Item #220011
Square Hard Case with Wheels
 - Our most versatile hard case; perfect for floor displays, retractable banners and tabletop displays.



Inside view

Item #220150
10' or 15' Tent Hard Case with Wheels
 - Holds 10' or 15' tent frames.

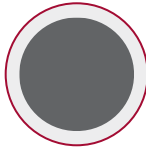

Inside view

Item #220024
Round Hard Case with Wheels
 - Compatible with a variety of our retractors and banner displays.

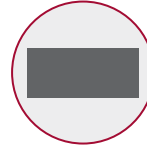

Inside view

Item #220020
Floor Display Hard Case with Wheels
 - Accommodates a vast array of floor displays and flat graphics.



Inside view

Item #220018
Display Hard Carry Case
 - Ideal for Fast Trak, Dynamo, and Show 'N Write displays.

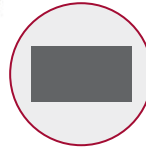

Inside view

Item #220395
Deluxe Hard Case with Wheels
 - Our foam-lined hard case is great for SEG displays and other display products.



Hard Cases

Item #	Description	Product Size	Product Wt.	1	2-5	6-11	12-24
220150	10' or 15' Tent Hard Case with Wheels	16.25"W x 66.88"H x 16.5"D	22 lbs.	407.75	399.50	391.50	379.25
220395	Deluxe Hard Case with Wheels	45.75"W x 22"H x 9.125"D	27.4 lbs.	832.00	815.50	790.50	774.00
220396	Deluxe Hard Case with Wheels	56.5"W x 26.75"H x 9.125"D	43.4 lbs.	1040.00	1019.00	988.00	967.00
220018	Display Hard Carry Case	39"W x 27.25"H x 4.5"D	10 lbs.	390.25	382.50	370.75	363.00
220020	Floor Display Hard Case with Wheels	45.5"W x 36.25"H x 9.25"D	32.4 lbs.	689.00	675.00	654.50	641.00
220023	Floor Display Hard Case with Wheels	55.75"W x 26"H x 10.25"D	25 lbs.	714.00	699.50	678.50	664.00
220017	Oval Hard Case with Wheels	26.25"W x 38.5"H x 17.5"D	24 lbs.	530.00	515.00	500.00	490.00
220024	Round Hard Case with Wheels	15"W x 42"H x 18.5"D	13.5 lbs.	333.50	326.75	316.75	310.25
220011	Square Hard Case with Wheels	15.5"W x 41.25"H x 17"D	22.25 lbs.	459.50	450.25	436.50	427.25

Hard cases cannot be imprinted.

USD MSRP (C)

HARDWARE SHIPS
SAMEDAY
 WHEN ORDERED BEFORE 2 PM CENTRAL

Prices are subject to change; visit our website for the most current pricing. See pages 208-211 for additional information that may apply to your order.

SOFT CARRY CASES

Our broad selection of cases helps you protect your investment by making transportation and storage simple.

- Soft carry cases are constructed of 600 denier polyester and feature straps
- Cases have a one-year warranty (excludes the zip-up clear poly bag)
- Color of soft carry cases may vary



Item #220009G
Table Throw Soft Carry Case
- Best for rolled table throws (see page 11 for details on storing throws).



Item #220107
Table Throw Messenger Bag
- Best for folded table throws; features shoulder strap for easy transportation.



Item #220069
Zip-Up Clear Poly Bag
- Ideal for folded EuroFit graphics.



Item #220010G
Soft Carry Case
- Perfect for Splash, GeoMetrix and Deluxe GeoMetrix Floor Displays. Multiple case sizes available.



Item #220085
Universal Retractor Case
36.25"W x 3.75"H x 5.25"D
- Perfect for 31.5" & 33.5" Economy, Economy Plus and Ideal retractors.



Item #220055
Universal Retractor Case
38"W x 4"H x 12"D
- Works well with several of our retractors.

Soft Carry Cases

Item #	Description	Product Size	Product Wt.	1	2-5	6-11	12-24
220010G	Soft Carry Case	34"W x 16"H x 14"D	2.25 lbs.	122.10	119.70	116.00	113.60
220007G	Soft Carry Case	38"W x 25"H x 5"D	2.5 lbs.	54.15	53.05	51.45	50.35
220107	Table Throw Messenger Bag	12.75"W x 13.5"H x 3"D	0.4 lb.	42.29	41.44	40.18	39.33
220009G	Table Throw Soft Carry Case	38"W x 5"H x 5"D	0.75 lb.	45.31	44.40	43.04	42.14
220085	Universal Retractor Case	36.25"W x 3.75"H x 5.25"D	2 lbs.	71.75	70.30	68.15	66.75
220055	Universal Retractor Case	38"W x 4"H x 12"D	4.5 lbs.	81.80	80.15	77.70	76.05
220069	Zip-Up Clear Poly Bag	14.5"W x 17"H x 3"D	0.25 lb.	3.96	3.88	3.76	3.68

Soft carry cases cannot be imprinted.

USD MSRP (C)

LED LIGHT KITS

Shine some light on your display with these kits, available in either single-light or double-light versions.



Ultimate LED Light Kits

Item #	Description	1	2-5	6-11	12-24
150120	Single Light Kit	181.20	175.80	170.30	164.90
150121	Double Light Kit	339.75	329.50	319.25	309.25

Kit Includes: Light(s), Clamp(s), Clip(s), USB Adapter and Soft Carry Case USD MSRP (C)

Prime LED Light Kit

Item #	Description	1	2-5	6-11	12-24
150133	Single Light Kit	160.00	155.20	150.40	145.60

Kit Includes: Light and Soft Carry Case USD MSRP (C)

EuroFit Light Clamp

Item #	Description	1	2-5	6-11	12-24
255125	Light Clamp	6.80	6.60	6.40	6.20

USD MSRP (C)



EuroFit light clamp (sold separately) attaches Ultimate LED Light Kits to horizontal tubing on compatible EuroFit displays.



Prime LED Light

Prime LED Light Kit

- Easy tightening clamp secures the light in place
- Clamp opens to 2.125"
- Ideal for use with the Journey SEG displays
- Plugs into any standard USA outlet
- Soft carry case included



Ultimate LED Single Light

Ultimate LED Light Kits

- 11.75" stalk puts almost a foot of distance between the light and the display
- Adjustable joints at both ends of the unit let you angle each light to maximize impact
- Interchangeable attachments feature a clamp or clip, each compatible with a broad variety of displays
- Each light is powered by an attached 10' USB cord
- Soft carry case included

Prices are subject to change; visit our website for the most current pricing. See pages 208-211 for additional information that may apply to your order.

HARDWARE SHIPS
SAMEDAY
WHEN ORDERED BEFORE 2 PM CENTRAL

TOTAL SHOW PACKAGES

When choosing a total show package
have you considered...

- **TIME** - Save time by purchasing products kitted to your specific event needs.
- **INSPIRATION** - Take the guesswork out of pairing products; every Total Show Package is designed to work together for a complete look and feel.
- **COST SAVINGS** - Receive discounted pricing and waived art setups with pre-bundled products.
- **VARIETY** - There's a Total Show Package for every event and setting; more packages available online.

VIEW OUR
**TRADESHOW
LOOKBOOK**



**TOTAL SHOW
PACKAGES**

**TOTAL SHOW
PACKAGES**

TOTAL SHOW PACKAGES



1

Suggested Uses

- Trade Shows
- Conferences
- College Recruiting
- Hospitals

TABLETOP CLASSIC

Our #1 Total Show Package is a triple threat, featuring three of our best-selling products.

- Lightweight and portable
- Includes hard shipping case with wheels



Table not included in package



Hard case with wheels

Cases



Table throw messenger bag

Item # 390023 - Tabletop Classic Total Show Package

Total Show Package Includes:		Price			Price
146015	6' Fast Trak Display with Full Graphic Panels	927.50	220107	Table Throw Messenger Bag	42.29
261002	33.5" Economy Plus Retractor Kit (No-Curl Hybrid Media)	343.00	220020	Hard Case with Wheels	689.00
104014	6'/8' Convertible Table Throw (Full-Color Front Only)	320.75		3 Setup Fees	60.00 FREE
Special pricing, substitutions not allowed				Regular Price	2392.54
				Special Package Price	2090.00
				SAVE	292.54

USD MSRP (C)



8' draped throw can be converted down to a 6' fitted throw.

Suggested Uses

- Registrations
- School Clubs
- Sporting Events
- Demonstrations

TRUNK-TO-ANYWHERE

Big messages fit into compact spaces with this portable package.

- Three Economy Retractors can be used for individual concepts or together to create an 8' back wall
- Case transforms into a podium



Everything fits nicely into the included Case-to-Podium.



Item #390024 - Trunk-to-Anywhere Total Show Package

Total Show Package Includes:		Price			Price
261134	3 - 31.5" Economy Retractor Kits (No-Curl Hybrid Media)	809.25	257030	ShowGoer Case-to-Podium Kit	686.00
Special pricing, substitutions not allowed				4 Setup Fees	80.00 FREE
				Regular Price	1676.25
				Special Package Price	1346.00
				SAVE	229.25

USD MSRP (C)

Prices are subject to change; visit our website for the most current pricing. Please note; Substitutions not allowed. See pages 208-211 for additional information that may apply to your order.

AFTER FINAL PROOF APPROVAL
PRODUCTION LEAD TIME IS
4 DAYS



Table not included in package

NEW
RECYCLED
POLYESTER
KNIT

Suggested Uses

- Trade Shows
- Promotions
- Meetings
- Sales Kits

CHANGE-UP

This package offers an attractive tabletop solution that is easy to set up and take down.

- Two EuroFit Straight Walls look great on any tabletop
- Recycled polyester knit is a 100% recycled media made with REPREVE® fibers; available for EuroFit Straight Wall
- 8' draped throw can be converted down to a 6' fitted throw

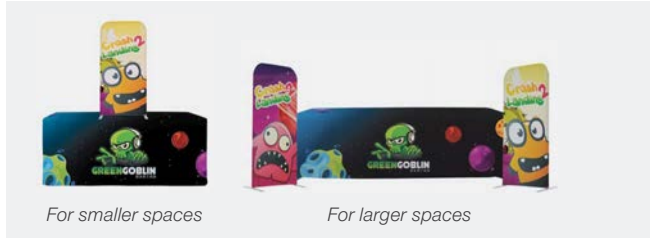

For smaller spaces

For larger spaces



Use the tabletop to lay out collateral and merch, and the EuroFit walls to accent the display.

Item #390028 - Change-Up Total Show Package

Total Show Package Includes:		Price		Price
104022	6'/8' Convertible Table Throw (Full-Color Full-Bleed)	320.75	254603	2 - 2'W x 49.5"H EuroFit Tabletop Straight Wall Kits 403.60
				3 Setup Fees FREE
				Regular Price 704.05
				Special Package Price 652.00
				SAVE 132.35
USD MSRP (C)				

Special pricing, substitutions not allowed



Table not included in package

NEW
RECYCLED
POLYESTER
KNIT

Suggested Uses

- Career Fairs
- Vendor Events
- Sales Meetings
- Conventions

8' draped throw can be converted down to a 6' fitted throw.

MICRO GEOMETRIX POP-UP

This package makes your presentation pop.

- The Micro GeoMetrix Classic kit features fabric graphic panels so you can create a custom look
- The double-sided EuroFit Straight Wall kit is a lightweight and stylish addition to this package
- Recycled polyester knit is a 100% recycled media made with REPREVE® fibers; available for EuroFit Straight Wall

Item #390033 - Micro GeoMetrix Pop-Up Total Show Package

Total Show Package Includes:		Price		Price
337207	Micro GeoMetrix Classic Kit	516.00	256215	3'W x 90"H EuroFit Straight Wall Kit 418.00
104022	6'/8' Convertible Table Throw (Full-Color Full-Bleed)	320.75	220011	Square Hard Case with Wheels 459.50
				3 Setup Fees FREE
				Regular Price 1774.25
				Special Package Price 1543.00
				SAVE 231.25
USD MSRP (C)				

Special pricing, substitutions not allowed



Case

Square hard case with wheels

AFTER FINAL PROOF APPROVAL
PRODUCTION LEAD TIME IS
4 DAYS

Prices are subject to change; visit our website for the most current pricing.
Please note; Substitutions not allowed.
See pages 208-211 for additional information that may apply to your order.

Suggested Uses

- Presentations
- Store Promotions
- Trade Shows
- Product Launches



PRODUCT PROMOTER

With a merchandise display, podium and vibrant backdrop, this combo packs a brilliant presentation into an easily transportable wheeled case.

- The 10' EuroFit Straight Wall kit is the perfect backdrop for a stunning presentation
- Recycled polyester knit is a 100% recycled media made with REPREVE® fibers; available for EuroFit Straight Wall
- Cascade Hanger Merchandiser includes a mount for a 23" monitor (not included), a shelf that holds up to 5 lbs. and a rack to hang up to 10 lbs. of apparel
- A Case-to-Counter Conversion kit transforms the hard case into a podium
- All of this breaks down and packs into the included Oval Hard Case with Wheels



Item #390187 - Product Promoter Total Show Package

Total Show Package Includes:		Price		Price	
256251	10'W x 90'H EuroFit Straight Wall Kit	1680.00	112008	UltraFit Case-to-Counter Conversion Kit	237.90
256390	EuroFit Hanger Merchandiser Kit	480.00	220017	Oval Hard Case with Wheels	530.00
				2 Setup Fees	40.00 FREE
				Regular Price	2967.00
				Special Package Price	2635.00
				SAVE	332.90

Special pricing, substitutions not allowed

USD MSRP (C)

Suggested Uses

- Parties
- Sporting Events
- Carnivals
- Trade Shows



PHOTO FUN INDOOR

This package gives you everything you need to create viral photo opportunities.

- A EuroFit Straight Wall kit makes a great photo backdrop
- Recycled polyester knit is a 100% recycled media made with REPREVE® fibers; available for EuroFit Straight Wall
- FrameWorx Face Cutout Quad kit creates fun photo ops for up to four people at a time
- A Selfie Frame gives your guests the chance to become social media stars



Item #390026 - Photo Fun Indoor Total Show Package

Total Show Package Includes:		Price		Price	
263334	8.5' FrameWorx Face Cutout Quad Kit	490.75	271131	24" x 36" Selfie Frame	27.31
256251	10'W x 90'H EuroFit Straight Wall Kit	1680.00	400052	Jumbo Easel	120.80
				3 Setup Fees	60.00 FREE
				Regular Price	2070.00
				Special Package Price	2087.00
				SAVE	291.86

Special pricing, substitutions not allowed

USD MSRP (C)

Prices are subject to change; visit our website for the most current pricing. Please note; Substitutions not allowed. See pages 208-211 for additional information that may apply to your order.

AFTER FINAL PROOF APPROVAL
PRODUCTION LEAD TIME IS
4 DAYS



Suggested Uses

- Pop-Up Shops
- Retail Spaces
- Conventions
- Vendor Events

PRODUCT SAMPLER

A perfect setup for displaying and distributing product samples.

- Draw attention to your booth with an 8' EuroFit Straight Wall
- EuroFit Evolution Two-Shelf display showcases your products
- Recycled polyester knit is a 100% recycled media made with REPREVE® fibers
- CounterPop provides a space for handing out samples and room for storage

Item #390213 - Product Sampler Total Show Package

Total Show Package Includes:		Price			Price
255180	8'W x 90"H EuroFit Straight Wall Kit	957.00	258243	3'W x 71"H EuroFit Evolution Two-Shelf Incline Wall Kit	945.00
257055	CounterPop Kit	634.50			
			3 Setup Fees		60.00 FREE
Special pricing, substitutions not allowed			Regular Price		2596.50
			Special Package Price		2283.00
			SAVE		313.50

USD MSRP (C)



Table not included in package

MARKET FEST

Make a splash at the next farmers market, fair or event with this easy-to-assemble tent package.

- Great for indoor or outdoor use
- Outdoor Fitted Table Throw works well in any environment
- Standard Tent kit provides shade at your event
- Unimprinted tent wall defines your space by adding a clean backdrop
- Premium Teardrop Sail Sign maximizes your advertising space
- Sail Sign mount works with your Standard Tent frame



Tent Kit Includes:



Soft Carry Case with Wheels

Stake Kit

Item #390177 - Market Fest Total Show Package

Total Show Package Includes:		Price			Price
240612	10' Standard Tent Kit (Full-Color Imprint, 2 Locations)	716.00	190687	11.5' Premium Teardrop Sail Sign Kit (Single-Sided with Ground Spike)	348.75
240082	10' Tent Full Wall (Black or White, Unimprinted)	84.60	240521	Sail Sign Mount for Standard Tent Frame	39.39
107060	6' Outdoor Fitted Table Throw	415.25	3 Setup Fees		60.00 FREE
Special pricing, substitutions not allowed			Regular Price		1663.99
			Special Package Price		1444.00
			SAVE		219.99

USD MSRP (C)

AFTER FINAL PROOF APPROVAL
PRODUCTION LEAD TIME IS
4 DAYS

Prices are subject to change; visit our website for the most current pricing.
Please note; Substitutions not allowed.
See pages 208-211 for additional information that may apply to your order.

MICRO GEOMETRIX MERCHANDISER

Perfect for the professional on the go, this Total Show Package is designed with portability in mind.

- Micro GeoMetrix back wall and clear shelves create the perfect pop-up product display; ideal for displaying small items
- 3' FrameWorx display is lightweight with a modern design for easy transport
- 6' Fitted Table Throw has a tight, fitted look
- All of this packs down into the included Oval Hard Case with Wheels



Table not included in package



Cases

Oval hard case with wheels



Table throw messenger bag

Item #390181 - Micro GeoMetrix Merchandiser Total Show Package

Total Show Package Includes:		Price		Price	
263061	3' FrameWorx Banner Display Kit (Single-Sided)	179.20	107002	6' Fitted Table Throw (Full-Color Front Only)	279.25
335064	Micro GeoMetrix 12-Quad Frame	372.50	220107	Table Throw Messenger Bag	42.29
337241	Micro GeoMetrix 12-Quad Back Wall Panel	407.75	220017	Oval Hard Case with Wheels	530.00
338069	6 Micro GeoMetrix Clear Shelves	253.50		3 Setup Fees	60.00
Special pricing, substitutions not allowed				Regular Price	2424.49
				Special Package Price	1858.00
				SAVE	266.49

USD MSRP (C)

TAILGATER

Show off your team spirit with this fantastic combination of tailgating products.

- Outdoor Fitted Table Throw works well in any environment
- Standard Tent kit provides shade at your event
- Outdoor Event Cooler holds up to 40 lbs. of ice to keep your beverages cold
- Premium Razor Sail Sign maximizes your advertising space
- Sail Sign mount works with your Standard tent frame



Table not included in package

Tent Kit Includes:

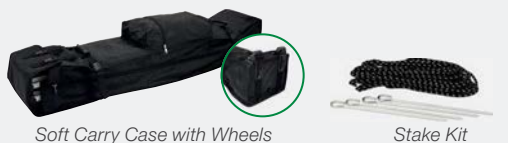

Soft Carry Case with Wheels

Stake Kit

Item #390025 - Tailgater Total Show Package

Total Show Package Includes:		Price		Price	
240612	10' Standard Tent Kit (Full-Color Imprint, 2 Locations)	716.00	190672	13' Premium Razor Sail Sign Kit (Single-Sided with Ground Spike)	348.75
107060	6' Outdoor Fitted Table Throw	415.25	240521	Sail Sign Mount for Standard Tent Frame	39.39
280240	Outdoor Event Cooler Kit	510.00		4 Setup Fees	80.00
Special pricing, substitutions not allowed				Regular Price	2409.99
				Special Package Price	1826.00
				SAVE	283.39

USD MSRP (C)

Prices are subject to change; visit our website for the most current pricing. Please note; Substitutions not allowed. See pages 208-211 for additional information that may apply to your order.

AFTER FINAL PROOF APPROVAL
PRODUCTION LEAD TIME IS
4 DAYS

GRAPHIC & PRINT GUIDELINES

PRODUCT TEMPLATES

Templates ensure artwork is printed correctly. Always use the most recent templates, which can be found in the "Templates/Specs" tab on each product page of our website.

- Do not leave template lines in artwork
- Templates for custom products are created after receipt of complete purchase order

Save TIME, MONEY and HASSLE with templates specifically created for each product.



Each template includes file setup specs for sizing your artwork, including the bleed, finished and safe areas.

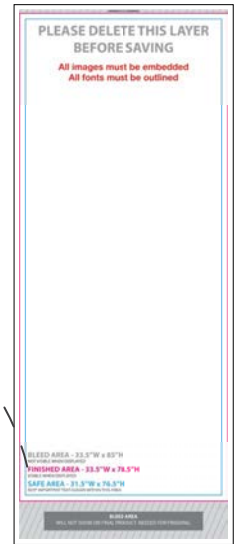

PRINT METHOD	ACCEPTABLE FILES	FILE FORMAT	PRINTING SPECIFICATIONS
FULL-COLOR IMPRINT	Vector with fonts outlined	Adobe Illustrator .ai .eps .pdf	All files are printed in CMYK (process color); PMS (spot) colors and RGB files will be converted to CMYK prior to printing Halftones/percentages of PMS colors are acceptable Minimum line thickness 0.125" (8-9 pt. stroke) Minimum of 0.25" width and height on all individual elements Minimum of 0.5" x 0.5" for all registered trademarks, trademarks, copyright symbols, etc.
FULL-COLOR INKJET & FULL-COLOR DYE SUBLIMATION	Vector with fonts outlined and links embedded Raster	Adobe Illustrator .ai .eps .pdf Adobe Photoshop (High Resolution) .tif .psd .eps .pdf .jpg	Use product template to set up print-ready artwork All files are printed in CMYK (process color); PMS (spot) colors and RGB files will be converted to CMYK prior to printing Full-color artwork including gradients, raster/photo images and bleeds Raster images must be created at actual size with 200 dpi resolution Minimum of 24 pt. reversed-out text Minimum of 12 pt. regular text Minimum line thickness: 1 pt. regular text, 2 pt. reversed-out text

VECTOR ART

(RECOMMENDED FOR ALL PRODUCTS)

- Can be scaled to any size while maintaining quality
- Known as line art
- Vector artwork is preferred (unless printing photos)



.eps, .ai, .pdf

RASTER ART

- Known as bitmap art
- Composed of pixels (or tiny squares) grouped together to make one complete image
- When scaled larger, the image will look pixelated (or jagged)
- Submit art at 200 DPI (dots per inch) at full size



.tif, .psd, .eps, .pdf, .jpg

OUTLINED FONTS

(REQUIRED FOR ALL PRODUCTS)

Font selection can vary from computer to computer, which can cause a desired font to be replaced with a generic one. To preserve your fonts, always outline, embed, or convert them to curves before submitting artwork.



Original font



Missing font replaced with a generic one



Original font when outlined, embedded or converted to curves

EMBEDDED IMAGES

(REQUIRED FOR ALL PRODUCTS)

Most programs allow the user to add an image to a file by linking or embedding. Embedded images are stored within the document itself, while linked files are not. Because of this, linked files can suddenly vanish when opened from a different computer. Embed all images to avoid losing them when files are submitted.



200 DPI

High resolution images include:
Unedited, original raw digital photos and stock photos

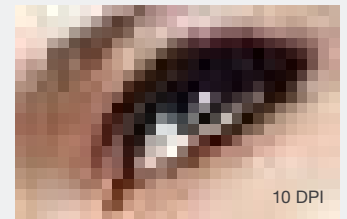

10 DPI

Low resolution images include:
Photos taken from the internet, scanned images, photos taken on a cell phone, screenshots, etc.

UNACCEPTABLE FILE FORMATS:

Quark, Corel Draw, Word, PowerPoint, Excel, Publisher, Pagemaker, low-resolution scanned images and files over 2 GB. (InDesign files, unless exported to .eps or .pdf format, will incur additional charges or be rejected).

FILE PREPARATION

PRODUCT TEMPLATES

Graphic templates can be found in the "Templates/Specs" tab on each product page of our website. Graphic dimensions are subject to change without notice.

REQUIREMENTS

Documents must be print ready and submitted at 100% final size, with no additional manipulation necessary; additional charges may apply if these terms are not met. Before submitting artwork, convert all text to outlines, paths or curves to ensure exact duplication of type style. Alterations to submitted artwork will result in a necessary proof approval, which may delay production time. We reserve the right to delay or reject any order based on the quality of the artwork received.

We also reserve the right to make slight alterations to your file to adapt to our printing process. Some thin lines or small shapes may not reproduce at the size or thickness submitted. Multicolor close-registration prints are not available on all products.

Please see page 208 for specific information relating to each print method.

ARTWORK SUBMISSION & PROOFING

UPLOADING ARTWORK

For the fastest and most efficient artwork processing, please submit art via our website.

You must have an account and be logged in. Our factory will not be held responsible for any server malfunction that affects the receipt of your files.

ELECTRONIC PROOFS

Proofs are provided electronically in PDF format. These depict a low-resolution representation of the final product and should not be used for final color output or image resolution. Additional proofs may incur a proof revision charge of \$10.00(G) each, plus additional design time. Proof approvals must be submitted via our online proofing system before production will begin.

All proof approvals received after 12 PM Central will be counted as received on the next business day. Production time begins after the final proof approval is received.

GRAPHIC DETAILS

ERRORS

We will not be held responsible for errors resulting from copy that was received or approved incorrectly.

TYPESETTING

Our normal art setup fee includes up to three lines of copy. If a specific font is required, the name of that font must be noted on your purchase order. If we do not have the desired font, the type will be re-set using a standard font or one that matches the desired font as closely as possible.

CHANGE OF COPY CHARGE

Whether for a new or repeat order, any request for an addition, deletion or change to the copy in a vector artwork file will result in an **\$10.00(G) Change of Copy Charge**.

REPEAT ORDERS

There are no setup fees for exact repeat orders placed within two years of original order. Any artwork older than two years must be resubmitted. Proof approvals are required on all repeat orders.

*****ARTWORK THAT HAS BEEN ALTERED IN ANY WAY CANNOT BE CONSIDERED FOR A REPEAT ORDER*****

COLOR

COLOR POLICY

All of our products are printed CMYK (process color). If your artwork requires a specific color, please request a test grid (see below).

WE CANNOT GUARANTEE COLOR MATCHING.

TEST GRID*

If you are concerned about a specific color, we suggest ordering a test grid. Test Grids are printed samples of your requested PMS (spot) color and its surrounding color family (e.g. reds, blues, etc.) Using process colors, we will replicate the PMS color within the processes capability. Please state on your purchase order that you are requesting a test grid and the specific PMS color(s) you are trying to achieve.

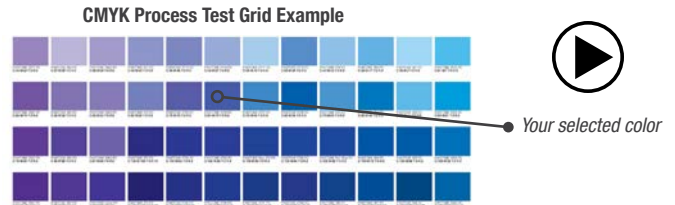

MATCH PRINT*

A match print is a 1/4 scale print of an entire art file. This is the most accurate way to represent an entire printed piece, since it will mimic the color and appearance of the piece as a whole, excluding any finishing. Please state on your purchase order that you are requesting a match print so it will be recorded on your order.

TEST STRIPS*

For the most detailed representation of full-size print quality and image resolution, we recommend requesting a test strip. An 8" x 20" section of the art is printed at 100%. Please state on your purchase order that you are requesting a test strip, including portion of art you would like to see, so it will be recorded on your order.

**The first test grid, match print and test strip is available at no charge (customer to pay freight). Each additional test grid, match print or test strip is \$20.00(G) plus freight, expedited charges apply.*

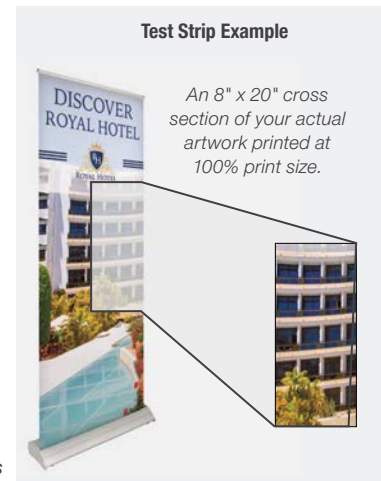

COLOR ACCURACY

Our customers deserve the highest-quality prints and most consistent, accurate color possible. As a G7 Master Qualified printer, we provide industry-leading color accuracy throughout our printing and production processes.

GENERAL INFORMATION

HOW TO ORDER

WEB ORDERS

Orders placed via our website will receive a 2% discount and setup fees will be waived. Submit art at time of order placement for faster order processing.

EMAIL ORDERS

Orders may be emailed.

PHONE ORDERS

Our Customer Care team is dedicated to helping you place an order. Please give us a call during our customer service hours: 7:00 a.m. to 5:30 p.m. Central, Monday through Friday

FAX ORDERS

Faxed orders are accepted as original orders. Any written confirmation of a faxed order must be marked "CONFIRMATION OF FAX – DO NOT DUPLICATE" to avoid duplicate orders.

HARDWARE-ONLY ORDERS

Most hardware-only orders placed before 2:00 p.m. Central will ship the same day (subject to capacity and inventory levels). Customer Care will inform you of any shipment delays at the time of ordering.

IMPRINTED PRODUCTS

Refer to the product's production lead time. See the DEFINITIONS section for details.

ALL ORDERS/APPROVALS RECEIVED AFTER NOON CENTRAL WILL BE PROCESSED ON THE NEXT BUSINESS DAY. OUR FACTORY IS NOT RESPONSIBLE FOR ANY OMITTED INFORMATION OR SERVER/FAX MALFUNCTIONS THAT AFFECT RECEIPT OF THE ORDER.

ORDERING DETAILS

PRICING

Prices are subject to change; visit our website for the most current pricing.

CREDIT/PAYMENT TERMS

All orders must be prepaid until credit terms are established. We accept Visa, MasterCard and American Express credit cards. All new customers are required to prepay their first order. Credit application is available on our website.

ORDER CHANGES & CANCELLATIONS

No graphic or product manufacturing changes will be accepted after final proof approval. Customer is responsible for all labor and material costs incurred prior to cancellation and will be billed accordingly.

SHIPPING

MULTIPLE DROP-SHIP ADDRESSES OR SPLIT SHIPMENTS

A \$5.00(G) fee will be added for each additional address, plus all applicable shipping and handling. Contact Customer Care for the formal drop-ship address document to complete. Additional fees may apply depending on the request.

SHIPPING

Visit our website for shipping information and packing dimensions. Printed products ship F.O.B. Ramsey, MN 55303 or Huntsville, AL 35811 see website for details. Special shipping and pricing guidelines apply to oversized products to ensure product is delivered intact and on time.

RETURN POLICY

CLAIMS/RETURNS

Any damages or discrepancies must be reported within five days of receipt of merchandise. We reserve the right to not honor any claims not reported within five days. Returns will not be accepted after 90 days and cannot be returned without prior authorization from our factory.

Returns may be subject to a 15% restocking fee. Contact Customer Care for additional processing information about claims or returns.

SUBSTITUTIONS

Due to unavoidable style modifications and enhancements to the products within this catalog, we may need to substitute a product with a similar item of comparable cost and style. We reserve the right to withdraw any product offering without prior notification.

DEFINITIONS

SETUP FEE - \$20.00(G)

The setup fee represents all costs of preparing print process-ready artwork for production, as well as email proofing and two years of archival storage. There is no setup fee when referencing a previous order within two years of order placement, for the same item using exact previous artwork.

Setup fee will not be applied to orders placed via our website.

PRODUCTION LEAD TIMES

A production lead time is the amount of time it takes our factory to produce a finished product once final proof approval is received. Production lead times are listed for each product on their respective catalog pages and are subject to capacity and inventory levels. Your order will be scheduled within our production lead times or with rush service as requested to meet a required in-hands date. The factory reserves the right to adjust lead times. Customers will be contacted regarding affected orders.

Production begins upon receipt of:

- Complete purchase order
- Payment/credit approval
- Production-ready artwork
- Final proof approval

Your order will ship on or before the scheduled ship date via the freight method requested on the purchase order.

RUSH CHARGES/FEES

For products not included in our Quick Ship program, rush service is available; this requires prior approval by Customer Care. All documents received after 12:00 p.m. Central will be counted as received on the next business day. Same-day service is not available.

Standard rush charges:

Subtract one business day from product lead time = \$75.00(G)
Subtract two business days from product lead time = \$125.00(G)

WARRANTY

All of our products are designed to be cost effective and durable. Unless otherwise stated on the product's catalog page, standard hardware warranty is a one-year parts and labor warranty, which warrants product against defects in material or workmanship. Warranties do not cover damage due to accidents, abuse, or normal wear and tear. Products found to be defective will be replaced or repaired at the discretion of our factory.

TRADEMARKS

By submitting artwork to our factory, the customer assumes full responsibility for its use. Our factory will not be held responsible for submitted artwork that violates applicable laws or restrictions.



PROP 65 APPROVED

All of the products in this catalog have been tested and have passed Proposition 65 standards. Every one of these products can be sold in the state of California without a Prop 65 warning label.

BEAUFORT SCALE - WIND RATING

Beaufort Number	Wind Speed (miles per hour)	Description	Wind Effects on Land
0	<1	Calm	Calm. Smoke rises vertically.
1	1-3	Light Air	Wind motion visible in smoke.
2	4-7	Light Breeze	Wind felt on exposed skin. Leaves rustle.
3	8-12	Gentle Breeze	Leaves and smaller twigs in constant motion.
4	13-18	Moderate Breeze	Dust and loose paper are raised. Small branches begin to move.
5	19-24	Fresh Breeze	Small trees begin to sway.
6	25-31	Strong Breeze	Large branches are in motion. Whistling is heard in overhead wires. Umbrella use is difficult.
7	32-38	Near Gale	Whole trees in motion. Some difficulty experienced walking into the wind.
8	39-46	Gale	Twigs and small branches break from trees. Cars veer on road.

Select products have been rated on the Beaufort Wind Scale. See rating icon underneath the product name. Wind ratings were determined utilizing all available securing/stabilizing options sold with or offered for the product.

LOOK AROUND YOU

PORTABLE SIGNS, BANNERS AND DISPLAYS ARE EVERYWHERE!



PROMOTING
Increasing Product Sales



INFORMING
Educating & Directing



ACTIVATING
Driving Membership Acquisitions



ENGAGING
Boosting Brand Involvement



ADVERTISING
Increasing Traffic Flow



BRANDING
Heightening Consumer Awareness

Valid through December 31, 2024



#295265

